

## **Audi A4**

### **Owner's Manual**

**Audi A4** englisch 9.07

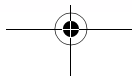

© 2007 AUDI AG

AUDI AG works continuously to develop and further improve all models. You will appreciate that we must therefore reserve the right to alter any part of the vehicle and its equipment or technical specifications at any time. No legal commitment can therefore be implied by the information, illustrations or descriptions in this Manual.

No part of this Owner's Manual may be reproduced, stored in a retrieval system, translated without the written permission of Audi AG, or used in any form under the laws of copyright. Subject to alteration and without notice.

**Date of publication: 27.06.2007**

 **For the sake of the environment**  
This paper was bleached without the use of chlorine.

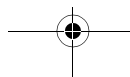

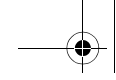

## Foreword

### Thank you for choosing the Audi A4.

The new Audi A4 combines the latest technology with numerous features for your comfort and convenience. To help you get the best out of these features in everyday use, we recommend that you read this Manual carefully so you can quickly become familiar with your vehicle in detail.

As well as information on how to use the controls and equipment, the Owner's Manual contains important notes on care and maintenance. These are relevant to your safety and will help preserve your car's value. The Manual also offers useful driving tips and advice, together with some suggestions on how to drive your car with minimum impact on the environment.

In addition to this Owner's Manual, the Service Wallet also includes the Service Schedule for your vehicle. This booklet contains important information on Audi service requirements and lists the vehicle's fuel consumption figures. The Service Wallet also includes operating manuals for optional on-board systems such as the radio, navigation and telephone. We recommend that you keep the Service Wallet in the car at all times.

Should you have any further questions regarding your car or if you suspect that your owner's literature is not complete, please contact your Audi dealer or importer. They are always glad to answer your queries and note any suggestions you may have.

We wish you safe and enjoyable motoring with your Audi A4.

**AUDI AG**

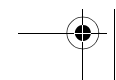
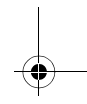
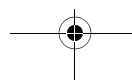
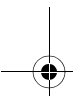
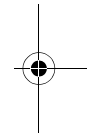
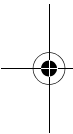

## Contents

### Notes on this Owner's Manual

5



### Controls

7

#### Controls and displays

9

##### Overview

9

#### Instruments and warning/indicator lamps

11

##### Instruments

11

##### Fuel gauge

14

##### Warning and indicator lamps

15

#### Driver information system

21

##### Introduction

21

##### On-board computer

25

##### Speed warning function

28

##### Auto-check control

30

##### Tyre pressure monitoring system

39

#### Doors and windows

42

##### Central locking system

42

##### Boot lid

51

##### Child-proof catches

53

##### Electric windows

53

##### Sun roof

55

#### Lights and vision

57

##### Lights

57

##### Interior lights

63

Clear vision

64

Windscreen wipers

65

Rear-view mirrors

68

Digital compass

71

#### Seats and storage

73

Manual adjustment of front seats

73

Electric adjustment of front seats

74

Seat memory

75

Head restraints

77

Front armrest

78

Luggage compartment

79

Roof carrier

83

Roof load

84

Cup holders

85

Ashtrays

86

Cigarette lighter and electrical

87

sockets

87

On-board 230 Volt Euro socket

89

Storage compartments

90

#### Heating and cooling

93

Deluxe automatic air conditioner

93

Deluxe automatic air conditioner -

100

basic settings

100

Deluxe automatic air conditioner

101

plus

101

Deluxe automatic air conditioner

109

plus - basic settings

109

Auxiliary heating and auxiliary

110

ventilation

110

Seat heating

114

#### Driving

116

Steering

116

Ignition lock

116

Starting and stopping the engine

118

with the advanced key

118

Electro-mechanical parking brake

121

Cruise control system

125

adaptive cruise control (ACC)

128

Speed and distance control system

128

Driver messages

134

System limitations

140

Audi braking guard

142

Audi lane assist

145

Audi lane assist

145

Audi side assist

149

Lane change assist feature

149

Notes

156

Audi drive select

159

Adjusting the vehicle set-up

159

Automatic gearbox

162

multitronic®, tiptronic (6-speed

162

gearbox)

162

Parking aid

169

General notes

169

Audi parking system

169

Audi parking system plus

170

Audi parking system advanced

171

Switching display and acoustic

177

signals on and off

177

Towing bracket

177

Error messages

178

HomeLink

179

Universal transmitter

179



<b>Safety</b> .....	185	<b>Driving tips</b> .....	221	<b>General maintenance</b> ...	243
Safe driving .....	186	Intelligent technology .....	222	Care of vehicle and cleaning ...	244
General notes .....	186	Electronic stabilisation program		General notes .....	244
Correct sitting positions .....	188	(ESP) .....	222	Care of exterior .....	244
Pedal area .....	191	Brakes .....	224	Care of interior .....	247
Stowing luggage safely .....	192	Power steering (servotronic) .....	225	Fuel and filling the tank .....	251
Seat belts .....	194	Four-wheel drive (quattro®) .....	226	Petrol .....	251
Why is it so important to use seat		Power management .....	226	Diesel .....	251
belts? .....	194	Your vehicle and the		Filling the tank .....	252
Forces acting in a collision .....	195	environment .....	229	Checking and topping up fluids	254
How to wear seat belts properly ..	197	Running in .....	229	Bonnet .....	254
Belt tensioners .....	199	Emission control systems .....	229	Engine compartment layout .....	256
Airbag system .....	201	How to improve economy and		Engine oil .....	257
Description of airbag system .....	201	minimise pollution .....	229	Cooling system .....	260
Front airbags .....	203	Environmental compatibility .....	231	Brake fluid .....	262
Side airbags .....	205	Towing a trailer .....	232	Battery .....	263
Head-protection airbags		Driving the vehicle with a trailer or		Windscreen washer .....	267
(sideguard) .....	207	caravan .....	232	Wheels and tyres .....	268
Deactivating the front passenger's		Removable towing bracket .....	235	Wheels .....	268
airbag via the key-operated switch	208			Run flat tyres .....	274
Child safety .....	210			Accessories and modifications	
Points to remember if children are				to the vehicle .....	277
travelling in the car .....	210			Accessories and replacement	
Child safety seats .....	213			parts .....	277
Fitting child safety seats .....	216			Modifications .....	277
				Radio transmitters and business	
				equipment .....	278

Controls

Safety

Driving tips

General maintenance

Self-help

Technical data



**Self-help** ..... 281

Self-help ..... 282  
Warning triangle ..... 282  
First-aid kit ..... 282  
Fire extinguisher ..... 283  
Tools and Tyre Mobility System ... 283  
Compact temporary spare wheel\* 284  
Tyre repairs ..... 285  
Changing a wheel ..... 288  
Jump-starting ..... 293  
Tow-starting and towing away ... 295

**Fuses and bulbs** ..... 300

Fuses ..... 300  
Bulbs ..... 304  
Changing bulbs for headlights ... 306  
Changing bulb for front fog lights 310  
Changing bulbs for rear lights in side panel ..... 311  
Changing bulbs in boot lid ..... 314  
Number plate light ..... 315

**Technical data** ..... 319

General notes ..... 320  
Explanation of technical data ... 320  
Dimensions ..... 320  
Capacities ..... 321  
Vehicle identification data ..... 321  
Performance, weights and dimensions ..... 323  
Petrol engines ..... 323  
Diesel engines ..... 325



**Index** ..... 329

## Notes on this Owner's Manual

This Owner's Manual contains important information, tips, suggestions and warnings.

Please ensure that this Owner's Manual is always kept in the vehicle. It should always be available to anyone else driving the vehicle, i.e. anyone renting, borrowing or buying the vehicle from you.

This manual describes **the equipment available for the vehicle at the time of going to print**. Some of the equipment described here will not be available until a later date, or may only be available in certain markets.

Some sections of this Owner's Manual do not apply to all vehicles. If this is the case, a text at the start of the section indicates which vehicles it applies to, e.g. "Applies to vehicles: with auxiliary heater". This optional equipment is also marked with an asterisk "\*".

**Illustrations** are intended as a general guide, and may vary from the equipment fitted in your vehicle in some details.

At the beginning of this Owner's Manual, you will find a **table of contents** showing all the items described in this manual in the order in which they appear. An **alphabetical index** is included at the end of the Owner's Manual.

All references to **positions** such as "left", "right", "front" or "rear" are given as seen facing in the direction of travel.

\* optional equipment

► The section is continued on the following page.

■ Denotes the **end of a section**.

® Registered trademarks are marked ®. However, the absence of this symbol does not constitute a waiver of the rights concerning any proprietary name.

⇒ ⚠ Refers to a "WARNING" within the same section. If the WARNING symbol is followed by a page number the warning text referred to is included in a different section.

### **WARNING**

Texts with this symbol contain safety information. They warn you of serious dangers, possibly involving accident or injury.

### **Caution**

Texts with this symbol draw your attention to a possible risk of damage to your vehicle.

### **For the sake of the environment**

Texts with this symbol refer to points relevant to the protection of the environment.

### **Note**

Texts with this symbol contain additional information of a more general nature. ■

Controls

Safety

Driving tips

General maintenance

Self-help

Technical data

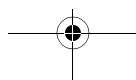
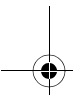
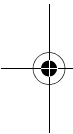



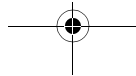
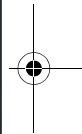
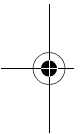

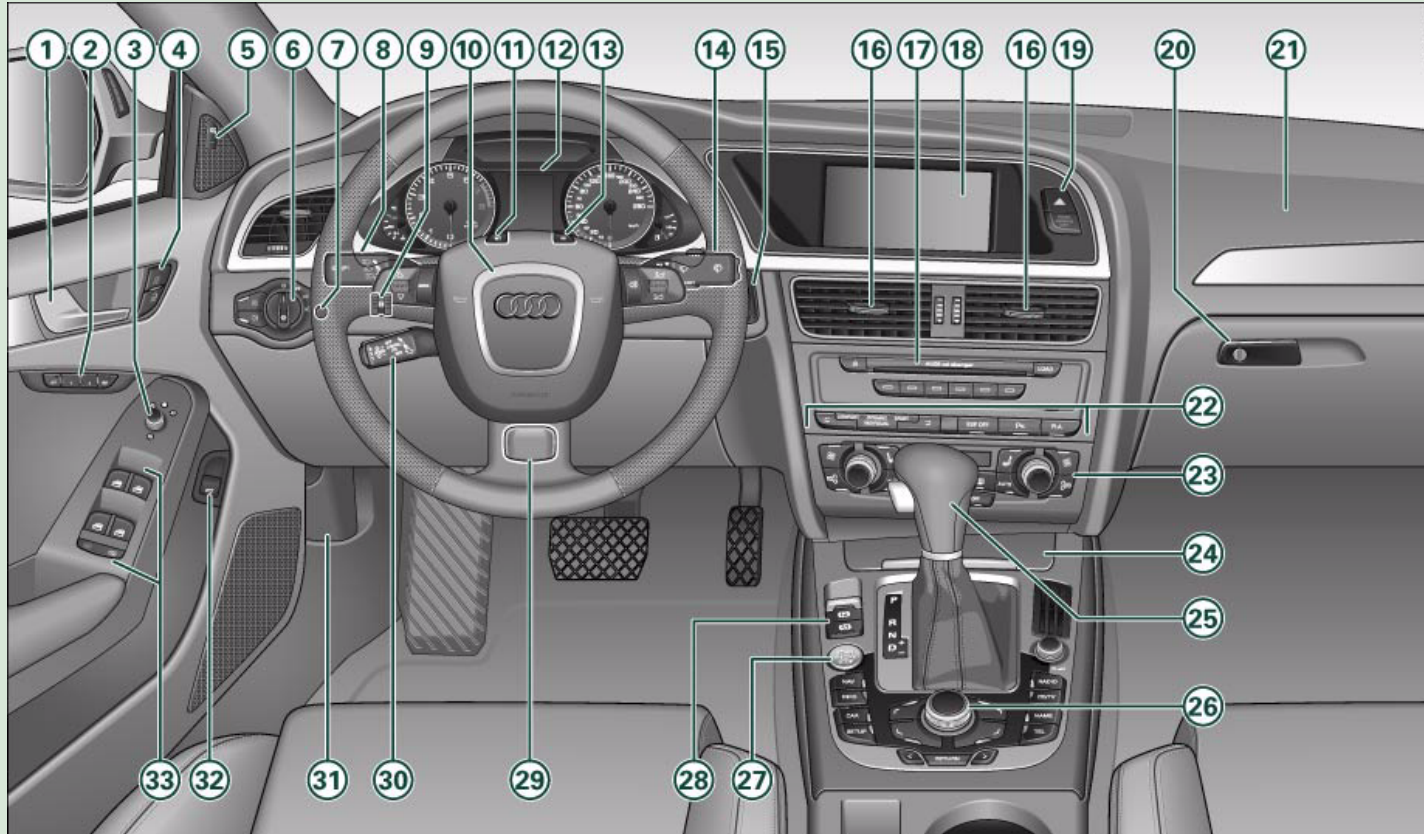

Fig. 1 Some of the items of equipment listed in this section are only fitted on certain models or are optional extras.

## Controls and displays

### Overview

① Door handle	
② Seat memory	75
③ Electric adjuster for exterior mirrors	70
④ Central locking switch	49
⑤ Button for side assist	149
⑥ Light switch	57
⑦ Instrument lighting	59
⑧ Control lever for:	
– Turn signals and main beam headlights	62
– lane assist	145
⑨ Headlight range control	61
⑩ Steering wheel with:	
– Horn	
– Driver's airbag	203
– Controls for audio, TV*, telephone and speech dialogue system*	
– Paddle levers for tiptronic gearshift	167
⑪ SET button	12
⑫ Instrument cluster	11
⑬ Reset button for trip recorder	14
⑭ Control lever for:	
– Windscreen wipers and washer	65
– On-board computer	25
⑮ Ignition lock	116
⑯ Air outlets with thumbwheel	107
– For deluxe automatic air conditioner	99
– For deluxe automatic air conditioner plus	107
⑰ Depending on equipment fitted:	
– Radio	
– CD changer	
⑱ Depending on equipment fitted:	
– Radio display	
– MMI display <sup>1)</sup>	
⑲ Hazard warning lights	
⑳ Glove box	90
㉑ Front passenger's airbag	203
㉒ Switches for the following (as applicable):	
– Audi parking system	170
– Electronic Stabilisation Program (ESP)	222
– Electric sun blind	64
– Control for Audi drive select	159
㉓ Air conditioner, depending on equipment fitted:	
– Deluxe automatic air conditioner	93
– Deluxe automatic air conditioner plus	101
㉔ Ashtray with cigarette lighter	86, 87
㉕ Depending on gearbox fitted, gear lever or selector lever for:	
– multitronic®	162
– Manual gearbox	
㉖ Depending on equipment fitted:	
– MMI control console or	
– Switch for Audi parking system	170
– Switch for Electronic Stabilisation Program (ESP OFF)	222 ▶

<sup>1)</sup> Depending on the equipment fitted in your vehicle the display screen is either two-coloured or multi-coloured. As the two displays are more or less identical this Owner's Manual uses the multi-coloured displays for illustration purposes.



- Switch for electric sun blind ..... 64
- Control for Audi drive select ..... 159
- 27 Start/stop button ..... 118
- 28 Electro-mechanical parking brake ..... 121
- 29 Adjustable steering column (hidden behind steering wheel) ..... 116
- 30 Depending on equipment fitted:
  - Cruise control system ..... 125
  - adaptive cruise control
- 31 Bonnet lock release ..... 254
- 32 Switch for releasing the boot lid ..... 51
- 33 Electric windows ..... 53



**Note**

- Please refer to the separate operating manual for instructions on using the Multi Media Interface (MMI).
- The arrangement of switches and controls on right-hand drive models\* may be slightly different from the layout shown in the illustration ⇒ *page 8*, fig. 1. However, the symbols used to identify the controls are the same. ■

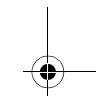
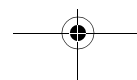
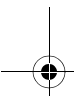
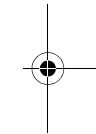
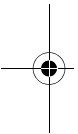

## Instruments and warning/indicator lamps

### Instruments

#### Instrument cluster overview

The instrument cluster is the driver's information centre.

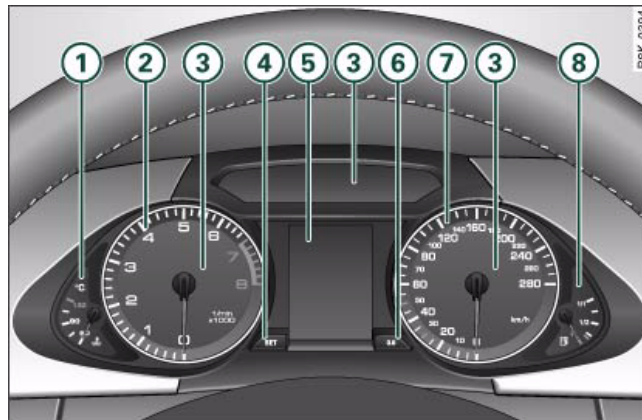

Fig. 2 Overview of instrument cluster

① Coolant temperature gauge .....	11
② Rev counter .....	12
③ Warning and indicator lamps .....	15
④ SET button .....	12
⑤ Display	
– Driver information system .....	21
– Date and time display .....	13
– Mileage recorder .....	14
⑥ Reset button for trip recorder .....	14

⑦ Speedometer .....	14
⑧ Fuel gauge .....	14

#### Note

- The needles in the instrument cluster will sweep across the dials when you switch on the ignition.
- The instrument lighting (illumination of dials and needles) is switched on when the ignition is on and the **vehicle's lights are off**. The instrument lighting is dimmed automatically as the daylight starts to fade. This function is intended to remind the driver to switch on the dipped-beam headlights in good time when light conditions become poor. ■

#### Coolant temperature gauge

The coolant temperature gauge ① ⇒ fig. 2 only works when the ignition is switched on. In order to avoid possible damage to the engine, please read the following notes for the different temperature ranges.

##### Engine cold

If the needle is still in the lower range of the dial, this indicates that the engine has not yet reached operating temperature. Avoid high engine speeds, full acceleration and heavy engine loads.

##### Normal temperature

In normal operation the needle will settle somewhere in the centre of the dial once the engine has reached operating temperature. The needle may also go further up when the engine is working hard at high outside temperatures. This is no cause for concern provided the warning symbol ⚠ in the display does not start flashing. ▶

**Warning symbol in instrument cluster** 

If the symbol  lights up in the display, this means that either the coolant *temperature* is too high or the coolant *level* is too low  
⇒ page 33.

If the needle is at the top end of the dial, this means the coolant temperature is too high. **Stop the vehicle, switch off the engine and wait for it to cool down.** If the warning lamp starts flashing again after just a short distance, contact a qualified workshop.

**WARNING**

- Before opening the bonnet and checking the coolant level, please observe the warning information on ⇒ page 255, "Working on components in the engine compartment".
- Never open the bonnet if you can see or hear steam or coolant escaping from the engine compartment; there is a risk of being scalded. Wait until you can no longer see or hear escaping steam or coolant.

**Caution**

- Additional lights and other accessories in front of the air inlet reduce the cooling effect of the radiator. At high outside temperatures and high engine loads, there is a risk of the engine overheating.
- The front spoiler also ensures proper distribution of the cooling air when the vehicle is moving. If the spoiler is damaged this can reduce the cooling effect, which could cause the engine to overheat. You should obtain professional assistance. ■

**Rev counter**

*The rev counter indicates the number of engine revolutions per minute.*

You should select a lower gear if the engine speed drops below 1500 rpm. The start of the red zone on the dial indicates the maximum engine speed which may be used briefly when the engine is warm and after it has been run in properly. However, it is advisable to change up a gear or move the selector lever to "D" (or lift your foot off the accelerator) before the needle reaches the red zone.

**Caution**

Never allow the rev counter needle  ⇒ page 11, fig. 2 to go into the red zone on the dial for more than a very brief period: there is a risk of damaging the engine. The start of the red zone on the dial is different for some engine versions.

**For the sake of the environment**

Changing up a gear early will help you to save fuel and minimise engine noise. ■

**SET button**

*This button has a number of different functions.*



Fig. 3 Instrument cluster: SET button

The **SET** button has the following functions:

#### Activating clock, date, temperature and mileage recorder displays

The display will appear for about 30 seconds if you press the **SET** button ⇒ *page 12*, *fig. 3* when the ignition is switched off.

#### Starting check procedure (auto-check control)

The auto-check control checks important components and vehicle systems. These background checks are run constantly, as long as the ignition is switched on ⇒ *page 30*.

You can start the "check procedure" manually by pressing the **SET** button with the ignition switched on. This function check can be started at road speeds up to 5 km/h.

#### Calling up driver messages again

A red or yellow symbol appearing in the instrument cluster display is normally accompanied by a corresponding message. The message will disappear from the display after about 5 seconds. If required, you can call up the message again by briefly pressing the **SET** button.

#### Setting speed warning

You can press the **SET** button briefly to set speed limit warning 1 **while the vehicle is moving** ⇒ *page 29*. If you press **and hold** the **SET** button, this will cancel the speed warning. ■

### Time and date display



Fig. 4 Instrument cluster: Time and date display

#### Quartz clock

The date, time and display format can be changed using the sound system or MMI\* control console. Please refer to the sound system or MMI\* Operating Manual for more details.

#### Radio-controlled clock\*

When the clock is in "radio-control" mode the signal reception symbol (a radio tower with radio waves) appears in the display ⇒ *fig. 4*. It is then not possible to change the minutes or the date manually.

#### Note

- The digital clock and mileage recorder displays are switched on for about 30 seconds when the driver's door is opened.
- When the ignition is switched off, the clock and date display can be switched on for about 30 seconds by pressing the **SET** button ⇒ *page 12*, *fig. 3* ⇒ *page 12*. ■

## Mileage recorder

The instrument shows how far you have travelled.



Fig. 5 Instrument cluster: Mileage recorder

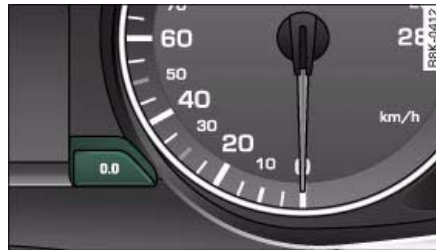

Fig. 6 Instrument cluster: Reset button

The mileage is stated in kilometres ("km") or "miles".

You can switch the display from kilometres to miles and vice versa via the sound system or MMI\* using the **CAR** button on the control console.

### Odometer / trip recorder

The odometer records the vehicle's total mileage.

The trip recorder shows the distance that has been travelled since it was last reset. It is used to measure individual journeys. The last digit of the trip recorder indicates distances of 100 metres or tenths of a mile.

The trip recorder can be reset to zero by pressing the reset button **0.0** ⇒ fig. 6.

### Fault display

If there is a fault in the instruments, the letters **dEF** appear permanently in the trip recorder display. Please have the fault rectified as soon as possible.

### Immobiliser

When the ignition is switched on, the security programming of the ignition key is verified electronically.

If an uncoded key is used, **SAFE** will appear continuously in the mileage recorder display. The vehicle cannot then be driven ⇒ page 43.

### Note

- The date, time and recorded mileage will continue to be displayed for about 30 seconds after you switch off the ignition.
- The digital clock and mileage recorder displays are switched on for about 30 seconds when the driver's door is opened.
- When the ignition is switched off, the mileage recorder can be switched on for about 30 seconds by pressing the **SET** button ⇒ page 12, fig. 3 ⇒ page 12. ■

## Fuel gauge

The gauge only works when the ignition is switched on.

When the needle reaches the reserve zone, the symbol  ⇒ page 37 lights up in the instrument cluster display together with the message **Please refuel**. At this point there are still about 8 litres of fuel left in the tank. This is your reminder **to fill up soon**.

The tank capacity of your vehicle is given in the **Technical data** section. ▶



**! Caution**

Never run the tank completely dry. The irregular supply of fuel can cause misfiring, which would allow unburnt fuel to enter the exhaust system. This can lead to overheating and damage to the catalytic converter. ■

**Warning and indicator lamps**



**Overview**

The warning and indicator lamps indicate a number of different functions and possible faults.



Fig. 7 Instrument cluster with warning and indicator lamps

	Dynamic steering	⇒ page 16
	Engine management (alternative to	⇒ page 16
	(alternative to	⇒ page 16
	Electronic stabilisation program (ESP)	⇒ page 17
	Airbag system	⇒ page 17
	Tyre pressure monitoring	⇒ page 17
	Left turn signals	⇒ page 18
	Trailer turn signals*	⇒ page 18
	Seat belt warning lamp	⇒ page 18
	Emission control system	⇒ page 18
	lane assist (active)	⇒ page 18
	lane assist (inactive)	⇒ page 18
	Main beam headlights	⇒ page 18
	Right turn signals	⇒ page 18
	Cruise control system*	⇒ page 19

	Anti-lock brake system (ABS)	⇒ page 19
	Electro-mechanical parking brake/Audi hold assist*	⇒ page 20
	Fault in brake system	⇒ page 20

Additional warning and indicator lamps are displayed on vehicles equipped with the adaptive cruise control\* ⇒ page 134.

### Note

A number of functions are monitored by the auto-check control ⇒ page 21. If a malfunction should occur, this will be shown by the display in the instrument cluster either with a red symbol (priority 1 – serious malfunction) or a yellow symbol (priority 2 – other malfunction or item requiring attention). ■

Applies to vehicles: with Audi drive select

### Dynamic steering

If the warning lamp  lights up when you switch on the ignition and goes out when the engine has started, the dynamic steering is activated.

If the warning lamp  stays on after the engine has started, this indicates a malfunction in the system. You can continue driving carefully at reduced speed to the next qualified workshop, however the steering may feel heavier and its response may be more sensitive than usual. In addition, it is possible that the steering wheel will be off centre when driving in a straight line.

** WARNING**  
**Have the system malfunction in the dynamic steering repaired by a qualified workshop as soon as possible – risk of accident.**

### Note

- If the warning lamp  flashes, this indicates that the dynamic steering is being initialised. The message “Dynamic steering: Initialising” ⇒ page 36 will appear in the driver information system display.
- The stabilisation functions of the dynamic steering ⇒ page 222 are not available in the event of a system malfunction. ■

Applies to vehicles: with petrol engine

### Engine management EPC

*This warning lamp monitors the engine management system on petrol engines.*

The EPC warning lamp (Electronic Power Control) lights up when the ignition is switched on to show that the lamp is working properly.

### Note

If the warning lamp lights up while the vehicle is moving, this indicates a fault in the engine management system. The engine should be serviced by a qualified workshop without delay. ■

Applies to vehicles: with diesel engine

### Glow plug system

*The indicator lamp lights up to show that the glow plugs are preheating.*

Your vehicle is equipped with an automatic glow plug system.

The indicator lamp  lights up while the glow plugs are preheating. If the engine fails to start immediately, the glow plugs have not finished preheating. In this case, keep the clutch pedal depressed (or keep your foot on the brake if your vehicle has an automatic gearbox) until the engine starts. ►

**Note**

- If the glow plug indicator lamp should start flashing while the vehicle is moving, this indicates a fault in the engine management system. The engine should be serviced without delay.
- If the indicator lamp fails to light up when the ignition is switched on, this can mean that the glow plug system is defective. The engine should be serviced. ■

**Electronic stabilisation program (ESP)**

*This warning lamp monitors the electronic stabilisation program.*

The warning lamp  has the following functions:

- It flashes when the ESP or traction control system (ASR) intervenes while the vehicle is in motion.
- The warning lamp will light up continuously if the ESP or the traction control system (ASR) has been switched off using the ESP OFF button ⇒ *page 222*.
- It lights up when the ignition is switched on and should go out again after about 2 seconds. This signals that the lamp is working properly.
- It will light up continuously if there is a malfunction in the ESP.
- It will also come on if a fault should occur in the ABS because the ESP operates in conjunction with the ABS.

If the battery has been disconnected, if the battery voltage is very low, or if the engine has been started from an outside power source, the ESP system will perform an initialisation of the various on-board sensors while you drive the first few metres. The warning lamp will light up during this period. It will go out when the initialisation has been completed.

If the warning lamp lights up and stays on after the engine is started, this may mean that the control system has temporarily switched off the ESP. In this case the ESP can be reactivated by

switching the ignition off and then on again. If the warning lamp goes out, this means the system is fully functional.

For further information on the ESP ⇒ *page 222*. ■

**Airbag system**

*This warning lamp monitors the airbag and seat belt tensioner system.*

The warning lamp  should light up for a few seconds when the ignition is switched on.

If the warning lamp does not go out, or if it lights up, flashes or flickers when the vehicle is moving, this indicates a malfunction in the system. This is also the case if the warning lamp does not light up when the ignition is switched on.

**WARNING**

**If a malfunction should occur, have the system checked immediately by a qualified workshop. If this is neglected, there is a risk that the airbag system and/or belt tensioners may not be activated in an accident. ■**



**Tyre pressure monitoring**

*The tyre pressure should be corrected as soon as possible if it is too low.*

If the  symbol flashes for about a minute and then remains lit after you switch on the ignition, there is a fault in the system. Please contact the nearest qualified workshop as soon as possible.

For more detailed information on the tyre pressure monitoring system, please refer to ⇒ *page 39*. ■

### Turn signals

Depending on which turn signal is operated, either the left  or right  indicator lamp flashes. Both indicator lamps will flash when the hazard warning lights are switched on.

If one turn signal should fail, the indicator lamp will start flashing twice as fast.

This does not apply when towing a caravan or trailer. The indicator lamp will stop flashing if one of the turn signals on the vehicle or the caravan/trailer should fail. For further information on the turn signals ⇒ [page 62](#). ■

Applies to vehicles: with towing bracket

### Trailer turn signals

*The indicator lamp flashes when the turn signals are operated while towing a caravan or trailer.*

The indicator lamp  flashes when the turn signals are operated, provided a caravan or trailer is correctly attached and connected to the vehicle.

The indicator lamp will not flash if one of the turn signals on the trailer fails. ■

### Seat belt warning lamp

*The warning lamp acts as a reminder to fasten the seat belts.*

After switching on the ignition, the warning lamp  will remain lit until the driver and front passenger (if applicable) have fastened their seat belts. When the vehicle has gathered speed you will also hear a warning chime.

For further information on the seat belts ⇒ [page 194](#). ■

### Emission control system

If the warning lamp **lights up continuously** you should take your vehicle to a qualified workshop as soon as possible in order to have the fault rectified.

If the warning lamp **flashes** drive on at reduced speed and seek professional help in order to avoid damage to the catalytic converter.

For further information on the catalytic converter ⇒ [page 229](#). ■

Applies to vehicles: with lane assist

### lane assist (active)

The indicator lamp confirms that the system is fully functional. You will be warned if you are about to cross the lane markings detected by the system.

For more information on the lane assist system, please see ⇒ [page 145](#). ■

### lane assist (inactive)

The warning lamp indicates that the system is switched on. However, you will not be warned if you cross the lane markings.

For more information on the lane assist system, please see ⇒ [page 145](#). ■

### Main beam headlights

The indicator lamp  lights up when the main beams are on or when the headlight flasher is operated.

For further information on the main beam headlights ⇒ [page 62](#). ■

Applies to vehicles: with cruise control system

### Cruise control

The indicator lamp  in the instrument cluster lights up when the cruise control system is operating. ■

### Anti-lock brake system (ABS)

*The warning lamp monitors the ABS and the electronic differential lock (EDL).*

The warning lamp  lights up for a few seconds when the ignition is switched on and while the engine is being started. The lamp goes out again once the system has run through an automatic test sequence.



#### There is a fault in the ABS if:

- the warning lamp  does not light up when the ignition is switched on,
- the warning lamp does not go out again after a few seconds,
- the warning lamp lights up when the vehicle is moving.

The vehicle can still be braked in the normal way (except that the ABS control function is out of action). Please take the vehicle to a qualified workshop as soon as possible. For further information on the ABS ⇒ *page 222*.

If a fault occurs in the ABS, the ESP warning lamp will also light up.

#### Fault in the main brake system



If the ABS warning lamp  lights up together with the brake warning lamp  ⇒ *page 32*, this indicates a fault in the ABS function, and possibly a malfunction in the main brake system as well ⇒ .

If there is a **malfunction in the brake system** the symbol  will light up in the instrument cluster. Please refer to ⇒ *page 32*.

### Fault on the electronic differential lock (EDL)

The EDL works in conjunction with the ABS. If a malfunction should occur in the EDL, this is indicated by the ABS warning lamp . Please take the vehicle to a qualified workshop as soon as possible. For further information on the EDL ⇒ *page 222*.

#### WARNING



- **Before opening the bonnet and checking the brake fluid level, observe the warning information on ⇒ *page 255*, "Working on components in the engine compartment".**
- **If the brake warning lamp  should light up together with the ABS warning lamp , stop the vehicle immediately and check the brake fluid level in the reservoir. If the fluid level has dropped below the "MIN" mark you must not drive on - otherwise there may be an increased accident risk. You should obtain professional assistance.**
- **If the brake fluid level is OK, the fault in the brake system may have been caused by a failure of the ABS control function. As a result the rear wheels can lock relatively easily when braking. This could cause the tail of the vehicle to skid sideways. Drive carefully to the nearest qualified workshop and have the fault rectified. ■**

Applies to vehicles: with Audi hold assist

### Audi hold assist

*This warning lamp monitors the Audi hold assist function.*

Audi hold assist helps the driver to keep the vehicle stationary while the engine is running, for instance on steep gradients, at traffic lights or in stop-and-go traffic. When the Audi hold assist function is on, you don't have to keep your foot on the brake to prevent the vehicle from accidentally rolling away. Once it detects that the vehicle is stopped, Audi hold assist keeps the vehicle stationary. The green symbol  in the instrument cluster indicates that the function is activated. You can now take your foot off the brake pedal. ►

When the vehicle has been stationary for an extended period, Audi hold assist will automatically apply the parking brake. In this case, the green symbol  will change to red . ■

### Electro-mechanical parking brake

*This warning lamp monitors the electro-mechanical parking brake.*

The warning lamp  lights up when the parking brake is applied with the ignition on. After the ignition has been switched off the lamp will stay on for about 30 seconds. The warning lamp will light up for about 30 seconds if the parking brake is applied with the ignition switched off.



The warning lamp should go out when the parking brake is released.

If the warning lamp flashes continuously **after the parking brake has been applied**, the brake may not be strong enough to hold the vehicle on a slope. This may be due to the brakes overheating. Please note the following points:



- If the gradient is too steep to park the vehicle safely, the display will show the message **Caution: Vehicle parked too steep**.
- In the event of a fault in the parking brake system the symbol  will also appear in the instrument cluster display together with the message **Parking brake!** You should have the fault corrected by a qualified workshop without delay. ■

### Brake system

*The warning lamp flashes if the brake fluid level is too low or if there is a fault in the ABS system or the parking brake.*

If the warning lamp  flashes, there is a fault in the brake system. The symbol  in the instrument cluster display will flash at the

same time. You can press the  button to obtain a message explaining the fault ⇒ *page 32*.

If a failure should occur in the ABS, the ABS warning lamp  will light up together with the brake warning lamp  ⇒ .

#### WARNING

- Before opening the bonnet and checking the brake fluid level, observe the warning information on ⇒ *page 255*, "Working on components in the engine compartment".
- If the brake warning lamp does not go out, or if it lights up when driving, the brake fluid level in the reservoir is too low – this may cause an increased accident risk. Stop the vehicle and do not drive on. You should obtain professional assistance.
- If the brake warning lamp lights up together with the ABS warning lamp, this can mean that the control function of the ABS is out of action. As a result the rear wheels can lock relatively easily when braking. This could cause the tail of the vehicle to skid sideways. Drive carefully to the nearest qualified workshop and have the fault rectified. ■

## Driver information system

### Introduction

#### General notes

The driver information system in the instrument cluster shows you the status of various on-board systems at a glance.



Fig. 8 Dashboard: Display in instrument cluster (automatic gearbox)

The display for the driver information system is in the centre of the instrument cluster.

The system runs a check on certain components and functions when the ignition is switched on and while the vehicle is moving. It gives an audible warning if a fault should occur or if servicing is required, and a red or yellow warning symbol (in some cases with a corresponding driver message) appears in the dashboard display.

The system will also display information for the radio and CD player and (if fitted) the route guidance directions from the **navigation system\***. For further information on these systems, please refer to the sound system or MMI\* Operating Manual.

On some models the display of information shown in the instrument cluster differs from the illustrations used here.

The driver information system includes the following functions:

CD and radio display	⇒ page 22
Outside temperature	⇒ page 22
Gear-change indicator	⇒ page 22
Digital speedometer*	⇒ page 23
Door catches/boot lid warning	⇒ page 24
Service interval display	⇒ page 24
Auto-check control*	⇒ page 30
Driver messages	⇒ page 30
Speed warning	⇒ page 28
On-board computer*	⇒ page 25
Selector lever positions for automatic gearbox*	⇒ page 163

#### Note

If a fault should occur, the display will show a red or yellow warning symbol. A red warning symbol indicates a **serious malfunction** ⇒ page 31. A yellow warning symbol indicates a less serious **malfunction**, or other item requiring attention ⇒ page 35. ■

Controls

Safety

Driving tips

General maintenance

Self-help

Technical data

### CD and radio display



Fig. 9 Display: Radio information

If no priority 1 or 2 faults have been detected by the auto-check control, the name or frequency of the current radio station and the selected waveband will appear the upper part of the display.

When a CD is playing, the display will show the current title. If the vehicle is equipped with a CD changer\* the display will also show the number of the CD being played (CD1 to CD6). ■

### Outside temperature display

The outside temperature is shown when the display is activated.



Fig. 10 Display: Outside temperature

At temperatures below +5°C a snowflake symbol appears next to the temperature display. This is to warn the driver to take extra care when there is a risk of **ice** on the road.

When the vehicle is stationary or travelling at very low speeds, the temperature displayed may be slightly higher than the actual outside temperature as a result of the heat radiated from the engine.

The temperature units can be set to °F or °C on the sound system or MMI\* system. The outside temperature is automatically displayed in the units you have selected. Please refer to the sound system or MMI\* Operating Manual for further details.

**! WARNING**

**Do not rely on the outside temperature display as an ice warning. Please bear in mind that there may be patches of ice on the roads even at outside temperatures around +5°C. ■**

Applies to vehicles: with manual gearbox and gear-change indicator

### Gear-change indicator

This additional indicator function can help to save fuel.



Fig. 11 Display: Gear-change indicator





Fig. 12 Display: Switching the gear change indicator on and off

You can activate and deactivate the gear-change indicator on the sound system or MMI\*.

#### Switching the gear-change indicator on and off

- Select: Function selector button (CAR) > Instrument cluster > **Suggested gear** ⇒ fig. 12.

To familiarise yourself with the gear-change indicator, we recommend driving in the normal way to start with. A gear change will be recommended if the gear you are in is not the most economical choice. The gear you are currently in and the recommended gear will be displayed ⇒ page 22, fig. 11.

- **Shifting up a gear:** The suggested gear appears to the **right** of the current gear when a higher gear is recommended.
- **Shifting down a gear:** The suggested gear appears to the **left** of the current gear when a lower gear is recommended.

Gears may occasionally be skipped (3 > 5). If no gear-change is recommended, you are already in the most economical gear.

#### Note

- The gear-change indicator is intended to help save fuel. It is not intended to recommend the right gear for all driving situations. In

certain situations, only the driver can choose the correct gear (for instance when overtaking, driving up a steep gradient or towing a trailer).

- The gear-change indicator in the instrument cluster ⇒ page 22, fig. 11 goes out when you press the clutch pedal. ■

Applies to vehicles: with on-board computer

#### Digital speedometer



Fig. 13 Display: Digital speedometer

The display shows the current speed. The speed is displayed in increments of 1 km/h. ■

### Door catches / boot lid warning

The pictogram shows whether the doors and the boot lid, etc. are properly closed when driving off.



Fig. 14 Display: Door catches/boot lid warning

The door catches/boot lid warning symbol lights up if *one or more* of the doors, or the bonnet or boot lid are not properly closed when the ignition is on. The symbol also indicates *which* of these is not properly closed ⇒ fig. 14.

The warning symbol disappears when all the doors, the bonnet and the boot lid are completely closed, and the driver information functions selected will then be displayed again. ■

### Service interval display

The service interval display detects when the next service is due for your vehicle.



Fig. 15 Instrument cluster display: Service interval display



Fig. 16 Display: Service interval display

You can see whether an oil change or service inspection is due in the Car menu on the sound system or MMI display. There are two display levels:

- **Service reminder:** When the next service date is approaching, **Service in---- km--- days** ⇒ fig. 15 will be shown in the instrument cluster display each time you switch on the ignition. The number of days and kilometres act independently of each other. **Service due!** will appear in the display when the number of days reaches zero, even if you have not yet driven the estimated number of kilometres remaining. Similarly, **Service due!** will appear in the display when ►

the number of kilometres reaches zero, even if the estimated period has not yet expired. The remaining distance and time are updated and displayed briefly each time you switch on the ignition.

- **Service due:** When a service is due, **Service due!** will appear in the display as soon as you switch on the ignition. The display reverts back to the standard display after a short time. In addition, a tone will sound.

#### Displaying distance and time to next service

In the Car menu, you can look up the distance and time remaining until the next oil change and next service inspection. To do this, select function selector button **CAR** > **Service interval display** ⇒ *page 24*, fig. 16.

The display may not be complete on new vehicles within the first 500 km.

#### Resetting the service interval display

Your Audi dealer resets the display after each service. You can only reset the oil change display yourself. To do this, select function selector button **CAR** > **Service interval display** > **Reset oil change interval**. The next oil change will be indicated as being due 15,000 km or one year (fixed service interval) after the oil change interval is reset.

#### ! Caution

The system cannot calculate the figures for the service indicator if the battery is disconnected from the vehicle, so no service reminder can be displayed during this time. Please remember that keeping to the correct service intervals is most important for the service life and residual value of the vehicle (and especially for the life of the engine). The period between two services must never be longer than the time specified in the Service Schedule, even if you only cover a low mileage during this time.

#### i Note

- Do not reset the display between oil changes - otherwise the display will be incorrect.
- The information in the service interval display remains intact if the battery is disconnected.
- The distance to the next service cannot be called up if the system has detected a Priority 1 fault (red symbol).
- If the service was not performed by a qualified workshop, the oil change interval display can only be set to “fixed service intervals” of 15,000 km. If you wish to continue with the “LongLife” service, you will need to have the oil change interval display reset by a qualified workshop. ■

## On-board computer

Applies to vehicles: with on-board computer

### Introduction

*The on-board computer provides you with useful information during a journey, including average and current fuel consumption, average speed, fuel range and driving time.*



Fig. 17 On-board computer: Fuel range ►



Fig. 18 On-board computer: Average fuel consumption

The following items of information are processed by the on-board computer and can be shown one after the other on the display in the instrument cluster.

#### Fuel range

The estimated fuel range is displayed in km. It shows how far the vehicle can be driven with the amount of fuel left in the tank, assuming the same style of driving. The fuel range is displayed in increments of 10 km.

The fuel range is calculated on the basis of the fuel consumption over the last 30 kilometres. The fuel range will increase accordingly if you drive in a more economical manner.

#### Average fuel consumption

This mode displays the average fuel consumption since the memory was last cancelled in litres/100 km. If required, you can use this display to adjust your driving style to achieve the desired fuel consumption.

#### Current fuel consumption

The display shows the current fuel consumption in litres/100 km. If required, you can use this display to adjust your driving style to achieve the desired fuel consumption.

The computer calculates the fuel consumption every 30 metres. The display switches to l/h (litres per hour) when the vehicle is stationary.

#### Average speed

This mode shows the average speed driven since the memory was last cancelled (in km/h).

#### Driving time

This display shows the period of time which has elapsed since the memory was last cancelled.

#### Distance covered

This display shows the distance you have covered since the memory was last cancelled.

#### Note

- The displays for fuel consumption (average and current consumption), fuel range and speed are shown in metric units. You can change the measurement units via the sound system or MMI\*.
- The information in the memory is cancelled if the battery is disconnected. ■

Applies to vehicles: with on-board computer

#### Memory

*The on-board computer has two automatic journey memories.*

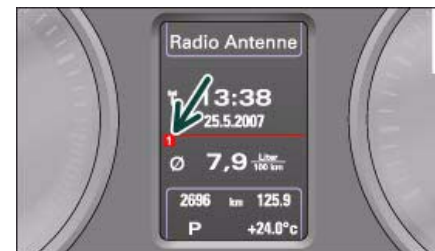

Fig. 19 On-board computer: Memory 1

Press RESET button **(B)** ⇒ fig. 20 to switch back and forward between the functions of on-board computers 1 and 2.

The number in the display ⇒ page 26, fig. 19 indicates which of the two memories is currently in use. The figure **1** means that the display is showing the information in the single journey memory (on-board computer 1). The figure **2** means that the display is showing the information in the total journey memory (on-board computer 2).

#### Single journey memory (on-board computer 1)

The single journey memory processes the information on a journey from the time the ignition is switched on until it is switched off. If the journey is resumed **within two hours** after the ignition is switched off, the new figures are automatically included in the calculation. The memory is automatically deleted when you resume driving, if the journey is interrupted for **more than two hours**.

#### Total journey memory (on-board computer 2)

Unlike the single journey memory, the total journey memory is not erased automatically. In this way, you can determine the period for which you wish the on-board computer to supply figures. ■

Applies to vehicles: with on-board computer

### Controls

*The on-board computer is controlled by means of two switches on the windscreen wiper lever.*



Fig. 20 Windscreen wiper lever: On-board computer controls

- Press the top or bottom of the function selector switch **(A)** ⇒ fig. 20. This displays the on-board computer read-outs one after the other.

The on-board computer can only be operated while the ignition is switched on. When the ignition is switched on, the display shows the function that was last selected.

As well as the figures from the on-board computer (computer 1 or 2), the display can also show information from other systems. Press the Reset button **(B)** briefly to switch back and forward between these displays.

#### Resetting figures to zero

To cancel one of the computer readings **individually**, select the required function and press the RESET button **(B)** for at least one second. The following values can be reset to zero **individually** using the Reset button:

- Average fuel consumption
- Average speed

- Driving time
- Distance covered

You can also cancel **all** the values in the single journey memory or the total journey memory at the same time ⇒ *page 28*.

### Note

The information in the memory is cancelled if the battery is disconnected. ■

Applies to vehicles: with on-board computer

### Basic settings for the on-board computer

*The basic settings for the on-board computer can be adjusted via the sound system or MMI\*.*



Fig. 21 MMI display: On-board computer

- Select: Function selector button **CAR** > **Instrument cluster** > **On-board computer 1** or **On-board computer 2**.

You can zero all the values in the single journey memory or the total journey memory at the same time by selecting the **Reset** menu item.

You can also define which items of information you wish to have displayed by the on-board computer. If one of these items is switched **off**, it will not appear in the display. However, the corresponding figures will still be registered by the on-board computer

and can be switched back **on** at any time so that they again appear in the display. ■

## Speed warning function

Applies to vehicles: with speed warning function

### Introduction

*The speed warning function can help you keep below a pre-set maximum speed.*

The speed warning function will warn you if the vehicle exceeds the pre-set maximum speed. The system gives an audible warning signal if the set speed is exceeded by about 3 km/h. A warning symbol will also appear in the display. On some models the symbol may look slightly different.

The speed warning function has **two** different warning speeds, which operate independently and serve slightly different purposes:

#### Speed limit warning 1

With speed limit warning 1, the maximum speed can be changed while driving. The speed limit that has been set remains stored until the ignition is switched off, or until it is changed or cleared.

The speed limit warning symbol  for speed limit warning 1 will appear in the display if you exceed the pre-set speed. It goes out again if the speed is reduced below the set speed limit.

The symbol also goes out if the speed is *increased* to more than about 40 km/h above the set speed for at least 10 seconds. This cancels the speed limit that was originally set.

Setting speed limit warning 1 ⇒ *page 29*.

#### Speed limit warning 2

You are recommended to store this speed limit warning if you *always* wish to be reminded of a particular speed limit. This could be when driving in countries with general speed limits, or if you ►

need to keep below a particular speed when winter tyres are fitted, etc.

The speed limit warning symbol  for speed warning 2 will appear in the display if you exceed the pre-set speed. Unlike speed limit warning 1, the warning symbol only goes out once the road speed has dropped below the stored value again.

Setting speed limit warning 2 ⇒ page 29.

### Note

Please bear in mind that, even with the speed warning function, it is still important to keep a check on the car's speed with the speedometer and to observe the statutory speed limits. ■

Applies to vehicles: with speed warning function

## Setting speed limit warning 1

You can use the **SET** button to set, alter or cancel speed limit warning 1.



Fig. 22 Detail of the instrument cluster: SET button

### Selecting speed limit

- Drive at the desired maximum speed.
- Press the **SET** button in the instrument cluster ⇒ fig. 22 for one second.

### Clearing speed limit

- Drive the vehicle at a minimum of 5 km/h.
- Press the **SET** button for at least 2 seconds.

The speed warning symbol  lights up briefly in the display to confirm that the selected speed has been stored. The speed limit that has been set remains stored until another speed is set with a brief push of the button, or until the memory is cleared with a long push of the button.

When the speed limit has been cleared, the display will show a crossed-out warning symbol . ■

Applies to vehicles: with speed warning function

## Setting speed limit warning 2

You can use the sound system or MMI\* to set, alter or cancel speed limit warning 2.



Fig. 23 Display: Setting speed limit warning 2

- Select: Function selector button **CAR** > Instrument cluster > Speed warning.
- **Speed warning on/off** - to activate or deactivate the speed warning function ⇒ fig. 23. ▶

- **Speed warning** - to set the speed above which a warning signal will sound.

Speed limit warning 2 can be adjusted in increments of 10 km/h between 30 and 240 km/h. ■

## Auto-check control

### Introduction

The auto-check control checks important components and vehicle systems. These background checks are run constantly, as long as the ignition is switched on.

A message is displayed in the instrument cluster if a fault should occur or if any maintenance or repairs are urgently required. This is accompanied by an audible warning signal. Depending on the priority of the fault, a red or yellow warning symbol lights up in the display.

The red symbols indicate a **serious malfunction**, whereas the yellow ones represent other **malfunctions** or items requiring attention. Additional messages to assist the driver may be shown with the red or yellow symbols.

### Automatic gearbox\* function test

The auto-check control automatically checks the vehicle systems when the ignition is switched on. If the selector lever is in position P or N, the following instruction will appear:

#### When stationary apply footbrake while selecting gear

When a gear (R, D etc.) is selected, this message disappears and the auto-check control function is displayed.

The driver message will disappear 30 seconds after switching on the ignition or earlier, if there are other driver messages or malfunctions.

If one or more faults are detected, the driver information message (as above) will disappear about 15 seconds after the engine has been started and the appropriate fault symbol(s) will appear in the display. The warning display will be accompanied by the corresponding warning chime. ■

Applies to vehicles: with speed warning function

### Driver messages

*Additional messages to assist the driver are displayed together with the warning symbols in the instrument cluster.*



Fig. 24 Instrument cluster: SET button

For example, the following driver message will appear if the selector lever for the automatic gearbox\* is not in position P when you switch off the engine:

**Shift to P, otherwise vehicle can roll away. Doors do not lock if lever is not in P.**

The ignition key can only be withdrawn when the selector lever is in this position. Similar messages will be displayed if other functions of this kind cannot be carried out.

### Driver messages and red symbols

If a red warning symbol appears in the display, it will automatically be accompanied by the corresponding driver message. ►



For example, in the event of an oil pressure malfunction the oil pressure symbol  will appear in the display. In addition, the following message will appear:

**Switch off engine and check oil level**

The message will disappear from the display after about 5 seconds. If required, the message can be called up again by briefly pressing the **(SET)** button ⇒ page 30, fig. 24.

**Driver messages and yellow symbols**

If a yellow warning symbol appears in the display, it will automatically be accompanied by the corresponding driver message.

For example, if the symbol  appears (windscreen washer fluid low), the display will also show the message:

**Please top up washer fluid**

The message will disappear after a few seconds. If required, the message can be called up again by briefly pressing the **(SET)** button. ■

**Red symbols**

*A red symbol warns of a serious malfunction.*



Fig. 25 Display: Symbol for serious malfunction

- Stop the vehicle.









- Switch off the engine.
- Check the function displayed. Obtain professional assistance if necessary.

The red symbols indicate a Priority 1 fault (serious malfunction).

Should a Priority 1 fault occur, a red warning symbol will appear at the top of the display ⇒ fig. 25. The symbol is accompanied by a driver message giving you more information about the fault. This symbol is accompanied by *three* warning chimes. The symbol will keep flashing until the fault is corrected.

If *several* Priority 1 faults are detected at the same time, the symbols are displayed one after the other for about 2 seconds at a time.

This message will disappear after about 5 seconds, but you can call it up again at any time by pressing the **(SET)** button ⇒ page 30.

	Alternator fault	⇒ page 32
	Fault in brake system/parking brake	⇒ page 32
	Coolant level too low / coolant temperature too high	⇒ page 33
	Engine oil pressure too low	⇒ page 33
	Add engine oil immediately	⇒ page 34
	Fault in the steering system	⇒ page 34
	Ignition lock defective	⇒ page 34
	Tyre pressure monitoring	⇒ page 39

### Alternator fault

If the symbol  flashes in the instrument cluster display, there is an alternator fault or a fault in the vehicle's electrical system. In addition, a message will appear. This message will disappear after about 5 seconds, but you can call it up again at any time by pressing the **(SET)** button.

You should normally be able to drive to the next available qualified workshop. However, you should avoid using electrical equipment that is not absolutely necessary because this will drain the battery.

#### **Caution**

If the coolant warning lamp  in the instrument display lights up as well as the alternator warning lamp while driving  $\Rightarrow$  *page 33*, stop the vehicle immediately and switch off the engine. In this case the coolant pump is no longer being driven, and there is a risk of engine damage. ■

### Fault in the brake system

*A fault in the brake system should be corrected as soon as possible.*

If the symbol  flashes in the display, there is a fault in the brake system. The symbol is accompanied by a driver message giving you more information about the fault. This message will disappear after about 5 seconds, but you can call it up again at any time by pressing the **(SET)** button:

#### **Stop vehicle and check brake fluid level**

- Stop the vehicle.
- Check the brake fluid level  $\Rightarrow$  *page 262*.
- Obtain professional assistance if necessary.

### **Warning! Fault in ABS brake system. Contact workshop**

- Drive carefully to the nearest qualified workshop and have the fault rectified  $\Rightarrow$  .

### **Parking brake ! Please contact workshop**

- If the symbol appears after you switch on the ignition when the vehicle is stationary, please check whether you can release the parking brake. If this is possible, you should drive without delay to the nearest qualified workshop and have the fault rectified. If the parking brake cannot be released you should obtain professional assistance.
- If this symbol should appear while driving, there may be a malfunction in the drive-away assist or the emergency brake functions. You may not be able to apply the parking brake. It is also possible that you cannot release the parking brake after it has been applied. Drive the vehicle to a qualified workshop and have the fault repaired.

If the ABS fails, the ABS warning lamp  will light up together with the brake warning symbol   $\Rightarrow$  .

#### **WARNING**

- Before opening the bonnet and checking the brake fluid level, observe the warning information on  $\Rightarrow$  *page 255*, "Working on components in the engine compartment".
- If the brake fluid level in the reservoir is too low, this could result in an accident. Do not drive on. You should obtain professional assistance.
- If the brake warning lamp lights up together with the ABS warning lamp, this can mean that the control function of the ABS is out of action. As a result the rear wheels can lock relatively 

**⚠ WARNING (continued)**

**easily when braking. This could cause the tail of the vehicle to skid sideways. Drive carefully to the nearest qualified workshop and have the fault rectified.**

**Note**

The warning lamp  in the instrument cluster will start flashing as well if there is a fault in the brake system. ■

**Fault in the cooling system **

*Faults in the cooling system must be rectified immediately.*

If the  symbol flashes in the display, this means that either the coolant *temperature* is too high or the coolant *level* is too low. The symbol is accompanied by a driver message giving you more information about the fault. This message will disappear after about 5 seconds, but you can call it up again at any time by pressing the **SET** button:

**Switch off engine, check coolant level**

- Stop the vehicle.
- Switch off the engine.
- Check the coolant level ⇒ *page 261*.
- Add more coolant if necessary ⇒ *page 261*.
- Wait for the symbol to go out before driving on.
- Obtain professional assistance if necessary.

If the coolant level is correct, the overheating may be caused by a malfunction of the radiator fan.

If the alternator warning lamp lights up as well ⇒ *page 32*, it is possible that the drive belt has broken.

**WARNING**

- If your vehicle should break down for technical reasons, stop it at a safe distance away from moving traffic, switch off the engine and turn on the hazard warning lights ⇒ *page 61*, "Hazard warning lights ".
- Never open the bonnet if you can see or hear steam or coolant escaping from the engine compartment; there is a risk of being scalded. Wait until you can no longer see or hear escaping steam or coolant.
- The engine compartment of any motor vehicle is a dangerous place. Before carrying out any work in the engine compartment, switch off the engine and allow it to cool down. Please observe the important safety warnings ⇒ *page 255*, "Working on components in the engine compartment".

**Caution**

Do not drive on if the symbol  has come on to indicate a fault in the cooling system, otherwise there is a risk of damaging the engine. ■

**Engine oil pressure too low **

*If the engine oil pressure is too low the fault must be rectified immediately.*

If the  symbol flashes in the display, the oil pressure is too low. The symbol is accompanied by a driver message giving you more information about the fault. This message ►

will disappear after about 5 seconds, but you can call it up again at any time by pressing the **(SET)** button:

#### Switch off engine and check oil level

- Stop the vehicle.
- Switch off the engine.
- Check the engine oil level ⇒ *page 258*.
- Obtain professional assistance if necessary.

#### If the engine oil level is too low

If the engine oil level is too low, add more oil ⇒ *page 259*.

#### If the engine oil level is correct

If the  symbol flashes and the engine oil level is correct, obtain professional assistance. Do not drive on. Do not continue to run the engine, **not even at idle speed**.



#### Note

The oil pressure warning lamp  is not an indicator for the oil level. The oil level should therefore be checked regularly. ■

### Add engine oil immediately

#### **WARNING! Please add oil immediately**

If the  symbol lights up, you must add oil immediately ⇒ *page 259*. ■

### Fault in the steering system

*The steering wheel cannot be unlocked if there is a fault in the electronic steering lock.*

If the symbol  flashes in the display, there is a malfunction in the electronic steering lock. The symbol is accompanied by a driver message giving you more information about the fault. This message will disappear after about 5 seconds, but you can call it up again at any time by pressing the **(SET)** button:

#### Do not drive vehicle. Steering defective

- You should obtain professional assistance.
- **Do not** have the vehicle towed away.

#### **WARNING**

**The vehicle must not be towed if there is a fault in the electronic steering lock: the steering will be locked and the vehicle cannot be steered. Towing a vehicle with locked steering can cause an accident.**





#### Note

On some models the symbol may look slightly different. ■

### Ignition lock defective

*A fault in the ignition lock must be rectified immediately.*

If the symbol  flashes in the display, there is a malfunction in the electronic ignition lock. The symbol is accompanied by a driver message giving you more information about the fault. This message will disappear after about 

5 seconds, but you can call it up again at any time by pressing the **SET** button:

#### Ignition lock defective. Contact workshop!

- **Do not** switch off the engine.
- Drive the vehicle without delay to a qualified workshop and have the fault repaired.

The ignition cannot be switched off if there is a fault in the electronic ignition lock. For this reason, you should drive the vehicle without delay to a qualified workshop and have the cause of the fault repaired.

If the vehicle is equipped with the advanced key\* feature, you should not switch off the engine with the Stop/Start button because it cannot be started again after the ignition has been switched off.



#### Note

On some models the symbol may look slightly different. ■

### Yellow symbols

*A yellow symbol indicates a malfunction or other item requiring attention.*



Fig. 26 Display: Yellow warning symbol







Yellow symbols indicate a Priority 2 fault.

Yellow symbols are accompanied by *one* warning chime. The symbol is accompanied by a driver message giving you more information about the fault. This message will disappear after about 5 seconds, but you can call it up again at any time by pressing the **SET** button.



The function indicated should be checked as soon as possible. The yellow symbol will only go out when the fault has been rectified.

If several Priority 2 faults are detected at the same time, the symbols are displayed one after the other for about 2 seconds at a time.

	Dynamic steering	⇒ page 36 and ⇒ page 159
	Brake pads worn	⇒ page 37
	Battery power*	⇒ page 38
	Bulb monitor*	⇒ page 37
	Bulb failure*	⇒ page 37
	Check engine oil level	⇒ page 38 or ⇒ page 38
	Engine oil sensor defective	⇒ page 38
	Fuel level low	⇒ page 37
	Washer fluid level low*	⇒ page 37
	advanced key*	⇒ page 36
	Key not in vehicle	⇒ page 36
	Light sensor/rain sensor defective	⇒ page 37
	Diesel particulate filter* obstructed	⇒ page 38

	Dynamic headlight range control* defective	⇒ page 39
	Battery in remote control key	⇒ page 44
	Electro-mechanical parking brake	⇒ page 123
	adaptive light* defective	⇒ page 39
	Ignition lock defective	⇒ page 39
	Windscreen wiper defective	⇒ page 39
	Suspension control	⇒ page 39
TPMS	Tyre pressure monitoring system	⇒ page 39

### Note

On some models the speed limit warning 1  and speed limit warning 2  will also be displayed as yellow symbols. These always appear as a small symbol at the top of the display ⇒ page 28. ■

Applies to vehicles: with Audi drive select

### Dynamic steering

#### Dynamic steering: system fault

This message and the  symbol will appear if a fault develops in the system while the vehicle is moving. You can continue driving carefully at reduced speed to the next qualified workshop, however the steering may feel heavier and its response may be more sensitive

than usual. In addition, it is possible that the steering wheel will be off centre when driving in a straight line.

#### Dynamic steering: initialising

If this message appears and the warning lamp  flashes in the instrument cluster, this indicates that the dynamic steering is being initialised. The steering wheel will move slightly after the engine is started. The dynamic steering may be initialised if the steering wheel was moved while the vehicle was stopped. The warning lamp will go out when the initialisation has been completed.

### WARNING

**Have the system malfunction in the dynamic steering repaired by a qualified workshop as soon as possible – risk of accident.**

### Note

The stabilisation functions of the dynamic steering ⇒ page 222 are not available in the event of a system malfunction. ■

Applies to vehicles: with advanced key

### Key not in vehicle

#### Key not in vehicle

This message will appear together with the symbol  if the remote control key is removed from the vehicle while the engine is running. This is to remind you not to continue driving without the key (for example if you change drivers).

If the remote control key is not in the vehicle you will not be able to switch on the ignition or restart the engine after it has been switched off. You will also not be able to lock the vehicle from the outside. ■

## Light sensor / rain sensor defective

### Automatic headlights / automatic wipers defective

If the  symbol appears, this means that the light sensor / rain sensor is not functioning. For safety reasons, the dipped beam headlights will then be switched on permanently when the light switch is set to the **AUTO** position. However, you can still switch the lights on and off in the normal way with the light switch. If the rain sensor is defective, the functions operated via the windscreen wiper lever will still be available. You should have the light sensor / rain sensor checked by a qualified workshop as soon as possible. ■

## Brake pads worn

### Brake pads!

If the  symbol lights up, have the front brake pads (and, for safety's sake the rear pads as well) inspected by a qualified workshop. ■

Applies to vehicles: with bulb monitor

## Bulb monitor

*The bulb monitor checks whether the lights on the vehicle are working.*

The bulb monitor checks whether the lights on the vehicle are working. If it detects a defective bulb on the vehicle it will show a yellow warning symbol together with a message indicating which light is not working.

### **Bulb failure**

If the symbol  lights up, this means that one of the turn signals (front or rear), headlights, brake lights, rear lights, fog lights or the rear fog light is not working.

## WARNING

- **Bulbs are sensitive to pressure. The glass can break when you touch the bulb, causing injury.**
- **Incorrect handling of the high-voltage element of xenon gas-discharge bulbs\* can have potentially fatal consequences.**

## Note

Have the components repaired or replaced by a qualified workshop. ■

Applies to vehicles: with washer fluid warning system

## Washer fluid level low

### Please top up washer fluid

If the  symbol lights up, top up the fluid for the windscreen washer and headlight washer system\* ⇒ *page 267*. ■

## Fuel level low

### Please refuel

When this symbol  comes on for the first time, there are about 8 litres of fuel left in the tank. You should fill up as soon as possible ⇒ *page 252*.

If this warning symbol lights up although the fuel tank is sufficiently filled, there is a malfunction in the fuel tank system. The display will also show the driver message **Tank system malfunction ! Contact workshop**. Please contact a qualified workshop. ■

Applies to vehicles: with battery power warning system

### Battery power

If battery power drops to a level at which you may encounter problems when starting the engine, the display will show the symbol  and the driver message **Low battery charge: Battery will be charged while driving.**

Please bear in mind that the starting ability of the engine may be impaired while this message is shown.

#### Message comes on and goes out again

If the message appears in the display after the ignition is switched on or while driving, and goes out again after a period of time, the battery has been charged up again sufficiently while the vehicle was being driven.

#### Message comes on and does not go out

If the message appears in the display after the ignition is switched on or while driving, and does not go out again, the battery is not being maintained at the proper power level. Starting reliability may be impaired. You should have the battery checked by a qualified workshop as soon as possible. ■

### Engine oil level (without dipstick)

#### Add oil, max. 1L. You may continue driving.

If the  symbol lights up in conjunction with this driver message, add not more than 1 litre of oil at the next opportunity ⇒ *page 259*. ■

### Check engine oil level (with dipstick)

#### Please check oil level

If the  symbol lights up in conjunction with this driver message, please check the engine oil level as soon as possible ⇒ *page 258*. Top up the oil at the next opportunity ⇒ *page 259*. ■

### Engine oil sensor defective

#### Oil level ! Sensor defective

If the  symbol lights up, take the vehicle to a qualified workshop and have the oil level sensor checked. Until then it is advisable to check the oil level every time you fill up with fuel ⇒ *page 258*. ■

Applies to vehicles: with diesel engine and diesel particulate filter

### Diesel particulate filter obstructed

#### Particle filter. See Owner's Manual

When the symbol  lights up you can assist the self-cleaning function of the filter by driving accordingly. You should drive at a speed of at least 60 km/h (engine speed about 2,000 rpm) for about 15 minutes in 4th or 5th gear, or with the selector lever in position S on vehicles with automatic gearbox\*. As a result of the increase in temperature the soot in the filter will be burned off. The symbol will disappear once the cleaning process has been completed successfully.

If the symbol  does not go out, please contact a qualified workshop and have the fault rectified.

For further information on the diesel particulate filter ⇒ *page 229*.

#### WARNING

**It is essential that you adjust your speed to suit the weather, road, terrain and traffic conditions. The recommended driving speed must never lead to the driver disregarding the traffic regulations. ■**



Applies to vehicles: with dynamic headlight range control

### Headlight range control defective

#### Headlight range control defective

This symbol  indicates a malfunction in the dynamic headlight range control. Take the vehicle to a qualified workshop to have the dynamic headlight range control function repaired. ■

Applies to vehicles: with adaptive light

### adaptive light defective

#### adaptive light defective

This symbol  indicates that the adaptive light is defective. Take the vehicle to a qualified workshop to have the headlights and/or the control unit for the adaptive light repaired. ■

### Ignition lock defective

#### Ignition lock defective

If the symbol  lights up in the display, there is a malfunction in the electronic ignition lock. Take the vehicle to a qualified workshop to have the problem remedied. ■

Applies to vehicles: with Audi drive select

### Suspension control

*This warning lamp monitors the damping effect of the shock absorbers.*

#### Suspension: system fault

If the  symbol lights up in the display, there is a malfunction in the vehicle suspension. Take the vehicle to a qualified workshop to have the problem remedied. ■

### Windscreen wipers defective

#### Windscreen wipers defective

This symbol  indicates a malfunction in the electronics for the windscreen wipers. Take the vehicle to a qualified workshop to have the windscreen wiper system repaired. ■

## Tyre pressure monitoring system

Applies to vehicles: with tyre pressure monitoring

### Tyre pressure monitoring display appears

*The tyre pressure monitoring display in the instrument cluster informs the driver if the tyre pressure is too low or a system malfunction has occurred.*



Fig. 27 Display: Warning message with symbol and text ▶



Fig. 28 Display: System fault ("Systemstörung")

The tyre pressure monitoring system makes use of the ABS sensors to compare the rolling circumference and the vibration of the wheels. The display in the instrument cluster alerts the driver if changes are detected on one or more wheels. If only one tyre is affected, the display will indicate its position ⇒ fig. 27.

Each time you change a tyre or the tyre pressures on your vehicle, you must store the new tyre pressures via the sound system or MMI\* ⇒ page 41.

The rolling circumference and vibration can change if:

- The tyre pressure is too low
- The tyre has suffered structural damage
- The air pressure in one or more tyres was changed and the new tyre pressures were not stored ⇒ page 41, "Storing the tyre pressures"
- The wheels were changed and the new tyre pressures were not stored ⇒ page 41, "Storing the tyre pressures"
- There is a greater load on the wheels of one axle (e.g. if you are carrying more passengers or luggage)
- The road surface under the left wheels is different to the road surface under the right wheels for a long period

#### Warning lamp / TPMS Tyre pressure ! System malfunction

If the warning lamp  flashes for about a minute and then remains lit after you switch on the ignition, there is a fault in the system.

**TPMS** (Tyre Pressure Monitoring System) **Tyre pressure ! System malfunction** ⇒ page 40, fig. 28 will also be displayed in the instrument cluster. Please contact the nearest qualified workshop as soon as possible.

#### WARNING

- If the tyre pressure warning lamp appears in the instrument cluster display, slow down immediately and avoid any severe braking or steering manoeuvres. As soon as you can do so safely, stop and check the tyres and the tyre pressures.
- It is the driver's responsibility to ensure that the tyre pressures are correct. For this reason you must check the tyre pressures regularly.
- Under certain conditions (e.g. driving at high speeds, on ice and snow or on poor road surfaces) the tyre pressure warning lamp may not light up immediately or not at all.
- Please ask your Audi dealer or qualified workshop whether run flat tyres can be used on your vehicle. Unauthorised use of these tyres can invalidate the vehicle's type approval for use on public roads. Furthermore, this could cause damage to your vehicle and possibly also result in an accident. ■

Applies to vehicles: with tyre pressure monitoring

### Storing the tyre pressures

*When you change a tyre or the tyre pressure on your vehicle, you must store the new tyre pressure via the sound system or MMI\*.*



Fig. 29 Display:  
Storing tyre pressures

- Switch on the ignition.
- Select: Function selector button **CAR** > **Tyre pressure monitoring** > **Store tyre pressures**. ■

## Doors and windows

### Central locking system

#### Description

The vehicle can be locked and unlocked via the central locking system. You can use any of the following:

- Remote control key ⇒ *page 47*
- Door handles in conjunction with advanced key\* ⇒ *page 47*
- Lock on driver's door ⇒ *page 48*
- Interior central locking switch ⇒ *page 49*

#### Unlocking one side of the vehicle only

When you lock the vehicle, the central locking system will lock the doors and the boot lid. When you unlock the vehicle, the central locking system will unlock either the driver's door *only*, or all the locks on the vehicle, depending on the setting you have selected on the sound system or MMI\* ⇒ *page 50*.

#### Automatic locking function (Auto Lock)

The Auto Lock function locks the doors and the boot lid when the vehicle exceeds a speed of about 15 km/h.

The vehicle is unlocked again when the ignition key is removed. Alternatively, the vehicle can also be unlocked via the central locking switch or by pulling one of the inside door handles. The Auto Lock function can be switched on and off on the sound system or MMI\* ⇒ *page 50*.

In the event of an accident in which the airbags inflate, the doors will be automatically unlocked to facilitate access and assistance.

#### Deadlock mechanism

The central locking system is combined with a deadlock mechanism. Once the vehicle has been locked from the outside, the door

handles on the inside are deactivated. This makes it more difficult to break into the vehicle.

#### Anti-theft alarm system\*

If the anti-theft alarm system senses interference with the vehicle it triggers an audible and visible alarm.

The anti-theft alarm system switches on automatically when the vehicle is locked. It switches off automatically if you unlock the vehicle using the **remote control**.

If you unlock the vehicle by inserting the **key** in the driver's door, the ignition must be switched on within 15 seconds, otherwise the alarm will be triggered. On some export versions, the alarm is triggered immediately when you open a door.

To deactivate the alarm, press the unlock button on the remote control key or switch on the ignition. The alarm will also switch itself off when it comes to the end of its cycle.

Switch off the interior monitor and tow-away protection if you wish to prevent the alarm from being triggered accidentally ⇒ *page 50*.

#### Turn signals

The turn signals will flash twice when the vehicle is unlocked and once when the vehicle is locked. If the turn signals do not flash, one of the doors, the bonnet or the boot lid is still open.

#### Accidental lock-out

The central locking system prevents you from being locked out of the vehicle in the following situations:

- When the driver's door is open, it cannot be locked together with the other doors by pressing the central locking switch and then closing the door ⇒ *page 49*.
- On vehicles with advanced key\*, the boot lid will be released again automatically if the remote control key that was last in use is left inside the boot when the boot lid is closed ⇒ *page 51*. ▶

To prevent yourself from being locked out, do not lock the vehicle with the **remote control key** before closing the doors or boot lid. If you accidentally press the locking button on your remote control key when any of the doors (except for the driver's door) are open, then put the key down inside the car and forget to take it with you when you close the doors, you can still open the doors for about one minute before the vehicle is locked.

### **WARNING**

**Do not leave anyone (especially children) in the car if it is locked from the outside and the deadlock mechanism is activated: the doors and windows cannot then be opened from the inside. Locked doors could delay assistance in an emergency, potentially putting lives at risk.**

### **Note**

- Never leave any valuable items in the vehicle unattended. Even a locked vehicle is not a safe.
- If the diode on the driver's window sill lights up for about 30 seconds when the vehicle is locked, the central locking system or anti-theft alarm\* is not working properly. Please have the malfunction repaired by an Audi dealer or qualified workshop.
- The interior monitor of the anti-theft alarm\* system will only function as intended if the windows and the tilting panorama roof\* are closed. ■

## Set of keys

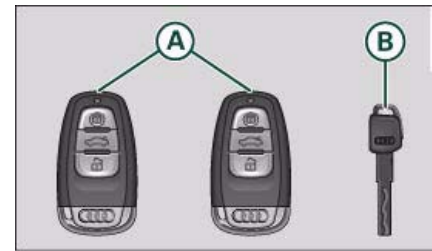

Fig. 30 Keys supplied with the vehicle

### **A** Remote control key

The remote control key will lock and unlock the car and start the engine.

### **B** Spare key

The spare key is intended for temporary use only and should be used only in an emergency. Keep it in a safe place and do not carry it on the keyring.

### Replacing a key

If you should lose a key, please contact an Audi dealer. Have the remote control coding for *that* key deactivated. For this purpose you should bring all available keys with you. It is also important to notify your insurance company if a key has been lost.

### Electronic immobiliser

The immobiliser is designed to prevent unauthorised persons from driving the vehicle. If an unencoded key is used, **SAFE** will appear in the mileage recorder display.

It may not be possible to start the engine with the key if there is another ignition key from a different make of vehicle on the same key ring. ►

**Data stored on remote control key**

Data related to the service and maintenance of the vehicle are stored continuously on your remote control key. Your Audi dealer can read out the data and will then be able to tell you what service work is required. This also applies to vehicles with advanced key.

**Personal convenience settings**

If two people use the same car regularly, it is a good idea for each person to have his or her "own" remote control key. When you switch off the ignition or lock the vehicle, your personal settings for the following convenience features are stored and assigned to the remote control key:

- Air conditioner
- Central locking system
- Windows
- parking system\*
- adaptive cruise control\*
- Audi drive select\*
- Seat memory\*

The stored settings are then recalled automatically the next time the vehicle is unlocked, the doors are opened or the ignition is switched on.

 **WARNING**

- **Always take the key with you when leaving the vehicle - even if you only intend to be gone for a short time. This is especially important if children are left in the car. They might otherwise be able to start the engine or use power-operated equipment such as the electric windows - this could lead to injuries.**
- **Wait for the vehicle to come to a standstill before removing the ignition key from the lock. Otherwise the steering lock could engage suddenly, causing an accident.**

 **Note**

The function of the remote control key may be impaired by interference from other nearby radio signals (for example from a mobile telephone or TV transmitter) if these are in the same frequency range. ■

**Indicator lamp on remote control key**

*The indicator lamp on the remote control key lights up when you press the buttons.*

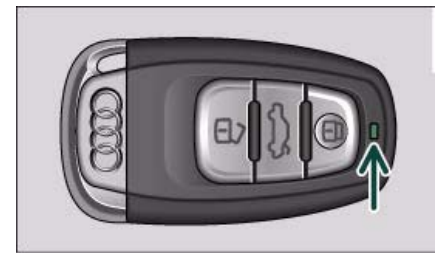

**Fig. 31 Indicator lamp on remote control key**

The indicator lamp should light up once briefly when you press one of the buttons briefly. The indicator lamp should flash when you press and hold one of the buttons (convenience open/close).

If the indicator lamp does not light up, this means the battery is exhausted and must be replaced ⇒ *page 45*. The instrument cluster display also shows the symbol  and the following message if the battery is exhausted:

**Please change key battery ■**

## Replacing the battery for the remote control key

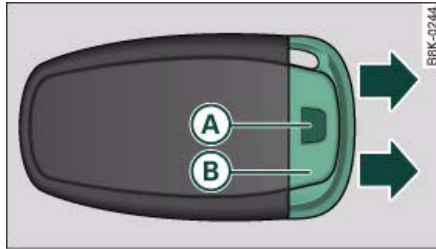

Fig. 32 Remote control key: Removing the emergency key

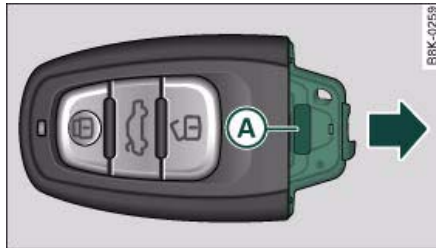

Fig. 33 Remote control key: Removing the battery carrier

- Press the release button (A) ⇒ fig. 32.
- Pull the emergency key (B) out of the remote control key.
- Press the release catch (A) ⇒ fig. 33 on the battery carrier and at the same time pull the battery carrier out of the remote control key in the direction of the arrow.
- Insert the new CR 2032 battery with the "+" symbol facing downwards.
- Slide the battery carrier carefully into the remote control key.

- Insert the emergency key.



### For the sake of the environment

Used batteries must be disposed of appropriately and must not be discarded with ordinary household waste.



### Note

The new battery must be of the same type as the original one (CR 2032). ■

## Removing the emergency key

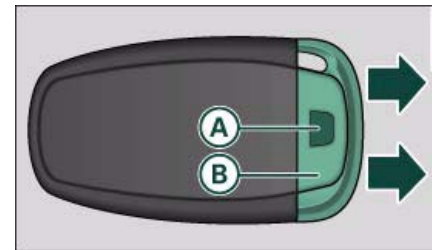

Fig. 34 Remote control key: Removing the emergency key

- Press the release button (A) ⇒ fig. 34.
- Pull the emergency key (B) out of the remote control key.

You can use the emergency key to ...

- activate and deactivate\* the front passenger's airbag ⇒ *page 208*.
- lock and unlock\* the glove box ⇒ *page 90*.
- lock and unlock the lockable rear seat.
- manually lock and unlock the vehicle if this is not possible using the remote control key ⇒ *page 48*. ■

### Emergency release for ignition key

In the event of a malfunction in the vehicle's electrical system, it may no longer be possible to remove the ignition key.

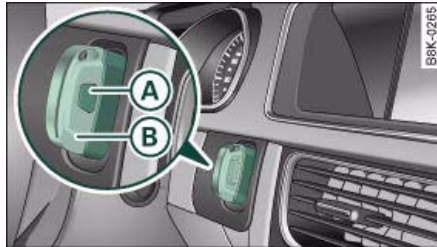

Fig. 35 Ignition lock with key

If you are not able to remove the ignition key because the vehicle battery has discharged (for example), remove the key as follows:

- Press the release catch (A) ⇒ fig. 35 using a ball-point pen or a similar object and pull the emergency key (B) out of the remote control key.
- Use the emergency key to lock the vehicle ⇒ *page 48*.
- Have the vehicle's electrical system checked by a qualified workshop. ■

### Starting the vehicle with the spare key

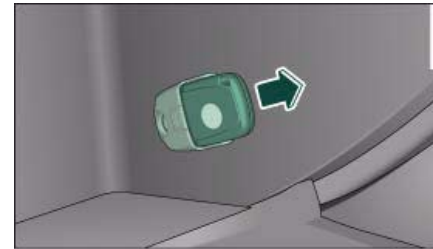

Fig. 36 Glove box: Adapter for spare key

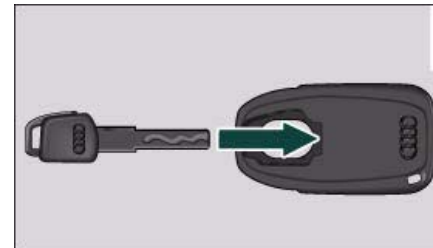

Fig. 37 Inserting the spare key into the adapter

- Take the adapter for the spare key out of the glove box ⇒ fig. 36.
- Slide the spare key ⇒ fig. 37 all the way into the adapter. Make sure that the Audi rings are facing upwards.
- Press the spare key in the adapter downwards until you hear it engage.
- Insert the adapter, spare key first, into the ignition lock. You should now be able to start the engine in the usual way. ■



## Locking and unlocking the vehicle with the remote control key

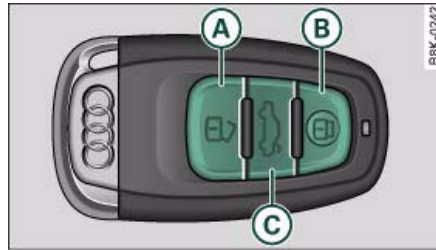

Fig. 38 Remote control key: Control buttons

- Press the button to unlock the vehicle ⇒ fig. 38.
- Press the button to lock the vehicle ⇒ .
- Press the button briefly to unlock the boot lid.
- Press the button for at least one second to open the boot lid.

The vehicle will be locked again automatically if you do not open one of the doors, the boot lid or the bonnet within 60 seconds after unlocking the car. This function prevents the vehicle from remaining unlocked if the unlocking button is pressed by mistake.

The system will either unlock all the doors or certain doors only, depending on the settings you have chosen on the sound system or MMI\* ⇒ page 50.

On vehicles with the advanced key\* the selector lever must be in P, otherwise it will not be possible to lock the vehicle.

### WARNING

Do not leave anyone (especially children) in the car if it is locked from the outside and the deadlock mechanism is activated: the

### WARNING (continued)

doors and windows cannot then be opened from the inside. Locked doors could delay assistance in an emergency, potentially putting lives at risk.

### Note

Do not use the remote control key when the vehicle is out of sight. ■

Applies to vehicles: with advanced key

## Locking and unlocking the vehicle with the advanced key

*The doors and the boot lid can be locked and unlocked without handling the remote control key.*

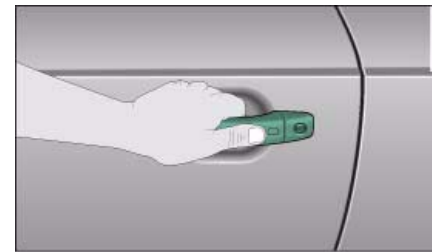



Fig. 39 Audi advanced key: Unlocking one of the doors

### Unlocking the vehicle

- Take hold of the door handle. The door will be unlocked automatically.
- Pull the door handle to open the door. ▶

### Locking the vehicle

- Move the selector lever to position P (automatic gearbox), otherwise it will not be possible to lock the vehicle.
- Touch the sensor on the door handle **once** to lock the vehicle ⇒ .
- Touch the sensor a second time **within 2 seconds** to lock the vehicle without activating the deadlock mechanism.

The vehicle can be locked and unlocked from any of the doors. The driver's door will always be unlocked as well when the passenger's door is unlocked. The remote control key has to be within a range of about 1.5 metres of the relevant door or the boot lid. It does not matter where you carry the key, for instance whether it is in your jacket pocket or in a briefcase.

The unlocking function may be affected if the sensor area on the door handle is touched while the vehicle is being unlocked.

The locking function may be affected if you grasp the door handle while the vehicle is being locked.

Once the doors have been locked, they cannot be opened again immediately. This will enable you to check that the doors are properly closed.

The system will either unlock all the doors or one door only, depending on the settings you have chosen on the sound system or MMI\* ⇒ *page 50*.

#### **WARNING**

**Do not leave anyone (especially children) in the car if it is locked from the outside and the deadlock mechanism is activated: the doors and windows cannot then be opened from the inside. Locked doors could delay assistance in an emergency, potentially putting lives at risk.**

#### **Note**

Please note the following points if the vehicle is left parked for long periods:

- To save electrical power, the proximity sensors are switched off after a few days. You will then need to pull the door handle once to unlock the vehicle, and a second time to open it.
- To prevent the battery from becoming discharged and thus maintain the vehicle's starting ability for as long as possible, the power management system will gradually switch off convenience functions that are not required. In this case you may not be able to unlock the vehicle with this convenience function. ■

### Locking and unlocking the vehicle using the key

*If the central locking system should fail to work, you can still lock and unlock the driver's door by turning the emergency key or spare key in the lock.*

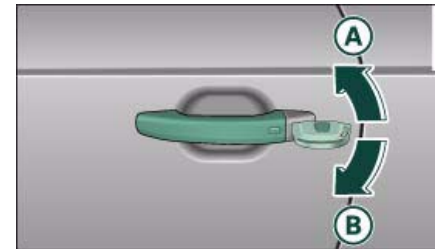

Fig. 40 Lock on driver's door

#### Unlocking

- Turn the key to position **A** ⇒ fig. 40 to unlock the vehicle. ▶

### Locking

- Move the selector lever to position P (automatic gearbox).
- Turn the key **once** to position **B** ⇒ **!** to lock the vehicle.
- If you turn the key to position **B** **a second time within 2 seconds**, this will lock the vehicle **without activating the deadlock mechanism**.

In order to switch off the anti-theft alarm\*, you must switch on the ignition within 15 seconds after opening the driver's door. Otherwise the alarm will be triggered.

If the central locking system should fail to work at any time, the passenger's door can be locked manually ⇒ *page 51*.

#### WARNING

**Do not leave anyone (especially children) in the car if it is locked from the outside and the deadlock mechanism is activated: the doors and windows cannot then be opened from the inside. Locked doors could delay assistance in an emergency, potentially putting lives at risk.**



#### Note

- The central locking switch and the release button for the boot lid  will function after the ignition is switched on.
- If the vehicle is locked with the key when the central locking system is operational, it is only possible to unlock all the doors and the boot lid centrally with the key within the next 45 seconds. After this period, the key will only unlock the driver's door. ■

### Central locking switch



Fig. 41 Driver's door: Central locking switch

- Press the  button to unlock the vehicle ⇒ fig. 41.
- Press the  button to lock the vehicle ⇒ **!**.

Please note the following when you use the central locking switch to lock your vehicle:

- The doors and the boot lid cannot be opened from the *outside* (for safety reasons, when stopped at traffic lights, etc.).
- The LED in the central locking switch lights up when both of the doors and the boot lid are closed and locked.
- You can open the doors individually from the inside by pulling the inside door handle.
- In the event of an accident in which the airbags inflate, doors locked from the inside will be automatically unlocked to facilitate access and assistance.

#### WARNING

- **The central locking switch is still operative when the ignition is switched off and will automatically lock the entire vehicle when pressed.**
- **The central locking switch inside the vehicle is not operative if you lock the vehicle from the outside.**

**⚠ WARNING (continued)**

- **Locked doors could delay assistance in an emergency, potentially putting lives at risk. Do not leave anyone (especially children) in the vehicle.**

**Note**

The doors and the boot lid are locked automatically when the vehicle reaches a speed of about 15 km/h (Auto Lock) ⇒ *page 42*. You can unlock the vehicle again via the central locking switch. ■

**Setting the central locking system**

*You can use the sound system or MMI\* to select which doors are unlocked by the central locking system.*



Fig. 42 Display: Central locking menu

- Select: Function selector button **CAR** > **Central locking** > **Unlocking single door**.

In the **Unlocking single door** menu you can specify which doors you wish to have unlocked when you unlock the vehicle using the remote control key or the advanced key\*. If you switch the **Unlocking single door** function **on**, only the driver's door will be unlocked when you press the unlocking button on the remote control key once.

You can still unlock all doors and the luggage compartment. To do so, press the unlock button **twice** on the remote control key.

When you lock the vehicle, the central locking system will automatically lock all the doors and the boot lid together.

If you select "Locking boot lid/tailgate" **on**, you can no longer open the luggage compartment using the handle on the boot lid ⇒ *page 52*, fig. 46. In this case, you can open the boot lid using the button on the remote control key ⇒ *page 47*, fig. 38 or the unlock switch on the driver's door ⇒ *page 51*, fig. 45.

If you select "Retract mirrors" **on**, the exterior mirrors will be retracted automatically ⇒ *page 70* when you press the lock button on the remote control key. ■

Applies to vehicles: with anti-theft alarm system

**Deactivating the interior monitor and tow-away protection**

Fig. 43 Front end of the driver's door: Switches for interior monitor and tow-away protection

When the vehicle is locked, the alarm will be triggered if movements are detected in the interior (e.g. by animals) or if the vehicle's inclination is changed (e.g. during transport). You can prevent the alarm from being triggered accidentally by switching off the interior monitor and/or tow-away protection. ▶

### Deactivating interior monitor

- Press switch **(A)** ⇒ page 50, fig. 43. The diode in the switch will light up.

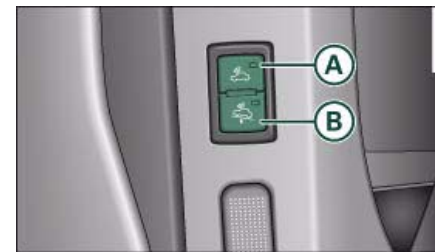
### Deactivating tow-away protection

- Press switch **(B)**. The diode in the switch will light up.

The interior monitor and tow-away protection will be switched on again automatically the next time the vehicle is locked.

#### **! WARNING**

**Do not leave anyone (especially children) in the car if it is locked from the outside and the deadlock mechanism is activated: the doors and windows cannot then be opened from the inside. Locked doors could delay assistance in an emergency, potentially putting lives at risk. ■**

### Locking the doors manually if the central locking fails to work

*If the central locking system should fail to work at any time, each door will have to be locked separately.*

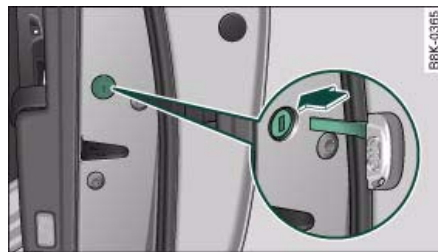

Fig. 44 Door: Locking the door manually

A mechanical locking device (only visible when the doors are open) is provided on the front passenger's door and the rear doors.

- Take the emergency key out of the remote control key ⇒ page 45.
- Pull the cap out of the opening ⇒ fig. 44.
- Insert the key in the slot inside and turn it as far as the stop to the right (if the door is on the right side) or to the left (if the door is on the left side).

Once the door has been closed it can no longer be opened from the outside. The door can be opened from the inside by pulling the door handle. If the child-proof catch is engaged on one of the rear doors, the door can be opened by pulling the inside door handle once and then opening the door from the outside. ■

### Boot lid

#### Opening and closing the boot lid



Fig. 45 Driver's door: Unlocking the boot lid ▶



Fig. 46 Release catch on the boot lid

### Opening boot lid

- Press the button on the remote control key for at least one second, or
- Pull the unlock switch on the driver's door ⇒ page 51, fig. 45, or
- Press the release catch on the boot lid ⇒ fig. 46.
- The boot lid is unlocked and opens automatically.
- Push the boot lid up slightly to secure it in the open position.

### Closing boot lid

- Pull down the boot lid by the handle on the inside and let it drop into the latch ⇒ .

### WARNING

- After closing the boot lid, always check that the catch has engaged properly. The boot lid could otherwise open suddenly when the vehicle is moving - this could result in an accident.
- The boot lid must always be completely closed when the vehicle is moving, otherwise toxic exhaust fumes can be drawn into the interior.

### Note

When the vehicle is locked, you can unlock the boot lid separately by pressing the button on the remote control key. The boot lid will lock automatically when you close it again. ■

### Manual release of the boot lid

*The boot lid can be released manually from the inside.*

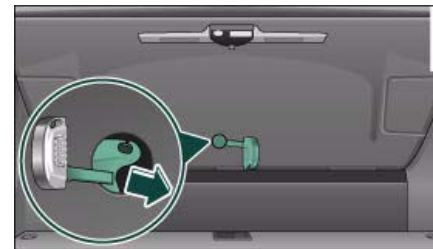

Fig. 47 Luggage compartment: Access to manual release

- Prise off the cover (using the emergency key) ⇒ fig. 47.
- Press the sliding lever in the direction of the arrow to unlock the boot lid. ■

## Child-proof catches

### Child-proof catches on the rear doors

The child-proof catches prevent the rear doors being opened from the inside.



Fig. 48 Child-proof catches on the rear doors

The rear doors are equipped with child-proof catches. The child-proof catches are only visible with the doors open. Take the emergency key out of the remote control key ⇒ page 45.

#### Engaging the child-proof catch

- Turn the key in the direction of the arrow ⇒ fig. 48.

#### Disengaging the child-proof catch

- Turn the key in the opposite direction of the arrow.

When the child-proof catch is engaged, the inside door handle will not function, and the door can only be opened from the outside. ■

## Electric windows

### Controls

The driver can operate all the electric windows.

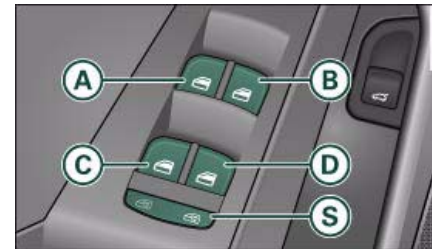

Fig. 49 Detail of the driver's door: Controls

All electric windows have **two-stage switches**:

#### Opening the windows



- Press the switch as far as the **first stop** and hold it until the window has moved to the desired position.
- Press the switch briefly **to the second stop**: the window will automatically open all the way.

#### Closing the windows



- Pull the switch as far as the **first stop** and hold it until the window has moved to the desired position.
- Pull the switch briefly **to the second stop**: the window will automatically close all the way.

#### Switches for electric windows

- Ⓐ Driver's door
- Ⓑ Front passenger's door

-  Rear door (left-side)\*
-  Rear door (right-side)\*
-  Safety switch

#### Child safety switch

When the safety switch  ⇒ page 53, fig. 49 is pressed in, the symbol  in the switch lights up. The window switches in the rear doors are deactivated.

#### WARNING

- Always take the key with you when leaving the vehicle - even if you only intend to be gone for a short time. This is especially important if children are left in the car. They might otherwise be able to start the engine or use power-operated equipment such as the electric windows - this could lead to injuries. The window switches are only deactivated when the driver's door or the front passenger's door is opened.
- Always be careful when closing the windows. Careless use of the electric windows can cause severe injuries.
- When locking the vehicle from the outside, make sure that nobody is inside the vehicle, as the windows cannot be opened from the inside in an emergency.

#### Note

The windows can be operated for about ten minutes after the ignition has been switched off. The window switches are only deactivated when the driver's door or the front passenger's door is opened. ■

#### Convenience open/close function



The convenience open/close function allows you to open and close the windows and the sun roof\* with the remote control key.

You can select which windows are opened in the settings on the sound system or MMI\* ⇒ page 55.

#### Convenience open function

- Press and hold the unlocking button  on the remote control key until the windows have reached the desired position and the sun roof\* is open.

#### Convenience close function

- Press and hold the locking button  on the remote control key until the windows and the sun roof\* are closed ⇒ .

#### Convenience close function with advanced key\*

- Touch and keep your hand in contact with the locking sensor on the door handle until the windows and the sun roof\* are closed.

#### WARNING

- Take care when closing the windows and the sun roof\*. Careless or uncontrolled use can cause injuries.
- For safety reasons, you should only use the remote control open and close functions within about 2 metres of the vehicle. To avoid injuries, always keep an eye on the windows when pressing the button to close them. The windows and sun roof stop moving as soon as the button is released. ■



## Settings for convenience open function

The driver can use the sound system or MMI\* to select which windows are opened.



Fig. 50 Display: Convenience open menu

- Select: Function selector button **CAR** > **Windows** > **Convenience open**.

If you wish to use the convenience open function for the windows and the sun roof\*, select **on** for the functions **Front doors**, **Rear doors** and **Sun roof**\*. ■

## What to do after a malfunction

The one-touch open and close function must be reactivated if the battery has been disconnected.

- Pull and hold the electric window switch until the window is fully closed.
- Release the switch and then pull it again for at least one second. ■

## Sun roof

### Controls



Fig. 51 Detail of headliner: Rotary control for sun roof

### Tilting open

- You can tilt the sun roof open or closed only when the switch is in the 0 position ⇒ fig. 51.
- Press the switch briefly to tilt open the sun roof.
- Pull the switch briefly to close the sun roof again ⇒ ⚠.
- To set an intermediate position, press or pull the switch until the sun roof has reached the desired position.

### Sliding open

- To slide the sun roof open to the position for low wind noise, turn the switch to position 1 (until you feel a resistance).
- To slide the sun roof fully open, turn the switch past the point of resistance to position 2 and hold the switch.
- To close the sun roof, turn the switch to position 0 ⇒ ⚠.

- You can set the roof to an intermediate position by turning the switch to the desired position.

The sun roof can be operated for about ten minutes after the ignition has been switched off. The switch is deactivated immediately when one of the front doors is opened.

#### Sliding sun blind with glass sun roof\*

The sliding sun blind can be opened and closed manually in any position. The sun blind opens automatically when you slide open the sun roof. When the sun roof is raised to the tilt position, the rear end of the sun blind is raised together with the sun roof.

#### WARNING

Take care when closing the sun roof. Careless or uncontrolled use of the sun roof can cause injuries. For this reason, always take out the ignition key when leaving the vehicle.

#### Caution

You should always close the sun roof when leaving the car. Sudden rain could seriously damage your car's interior equipment, especially the on-board electronic systems.

#### Note

- Should you not be able to close the tilted sun roof, pull and hold the switch until the sun roof is closed.
- Details on the convenience open/close function ⇒ *page 54*. ■

### Closing the sun roof manually



Fig. 52 Detail of headliner: Unscrewing the light housing



Fig. 53 Detail of headliner: Crank for manual operation

- Open the compartment for (sun)glasses. The screw ⇒ fig. 52 will then be visible.
- Remove the screw and detach the light unit.
- Insert the crank all the way into the hexagonal socket ⇒ fig. 53 and turn. The sun roof will now close.

#### Note

To make it easier to turn the crank, you can make use of the screwdriver handle (tool kit). ■

## Lights and vision

### Lights

#### Switching lights on and off



Fig. 54 Dashboard: Light switch

#### Switching on automatic headlights\* (AUTO)

- Turn the light switch to **AUTO** ⇒ fig. 54.

#### Switching on the side lights

- Turn the light switch to position .

#### Switching on dipped headlights

- Turn the light switch to position .

#### Switching off the lights

- Turn the light switch to position **O**.

The dipped beam headlights will only work with the ignition on.

The symbol  next to the light switch will light up when the side lights or headlights are on.

#### Automatic headlight control (AUTO)\*

When the switch is set to **AUTO**, the headlights switch on automatically according to the ambient light conditions, for instance in a tunnel, at sunset, or in the rain or snow. The  symbol lights up when the dipped headlights are on. The headlights are switched on, regardless of the light conditions, when you switch on the fog lights.

The headlights are switched off automatically when you switch off the ignition.

On vehicles with a rain sensor, the headlights switch on automatically after several windscreen wiper cycles. The instrument lighting does not switch on, however.

While using the automatic headlights you can activate the main beam headlights as normal if this function has been activated in the MMI. However, if you switch on the main beam headlights while using the AUTO function and then do not switch back to the dipped headlights setting, only the dipped headlights will come on the next time you switch on the AUTO function. To be able to use the main beam headlights again you must first pull the main beam lever back to the "off" position and then push it forward to "on".

#### Malfunction of light sensor

If a malfunction should occur in the light sensor, the instrument cluster will show the message:

#### Automatic headlights / automatic wipers defective

For safety reasons, the dipped beam headlights will then be switched on permanently when the light switch is set to the **AUTO** position. However, you can still switch the lights on and off in the normal way with the light switch. You should have the light sensor checked by a qualified workshop as soon as possible. ►

**WARNING**

The automatic headlights are only intended to assist the driver. The driver must always ensure that the headlights are used when required, and may have to switch them on manually when the light conditions or visibility are poor. For example, the light sensors are not able to detect fog. Therefore, you should always switch on the headlights  in these conditions and when driving after dark.

**Note**

- The light sensor for automatic headlight control is located in the mounting for the interior mirror. Do not affix any stickers on this section of the windscreen to avoid malfunctioning of the sensor.
- Some of the settings for the exterior lighting can be adjusted ⇒ page 59.
- If the lights are left on after the key has been taken out of the ignition lock, a buzzer sounds when the driver's door is opened.
- The use of the lighting described here is subject to the relevant statutory requirements.
- The coming home/leaving home function is active only when the light switch is set to AUTO. ■



**Fog lights**

Fig. 55 Switch for front fog lights

- Press button ① ⇒ fig. 55 to switch on the front fog lights .
- Press button ② to switch on the rear fog lights .

**Front fog lights**

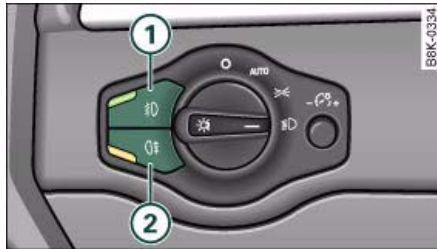
The side lights or headlights must be switched on. The green diode at the edge of the switch lights up when the front fog lights are switched on.

When the headlights are set to AUTO, the dipped headlights are switched on automatically when you switch on the front fog lights.

**Rear fog lights**

The headlights or side lights and the front fog lights must be switched on.

The yellow diode at the edge of the switch lights up when the rear fog lights are switched on.

If you are towing a trailer or caravan equipped with a rear fog light on a vehicle with a factory-fitted **towing bracket**, only the rear fog light on the trailer or caravan will light up.

**Caution**

To avoid dazzling the traffic behind you, the rear fog light should only be used in accordance with statutory regulations. ■

## Exterior lighting settings

You can change the settings for these functions on the sound system or MMI\*.



Fig. 56 Display: Exterior lighting

Important: .

- Select: Function selector button **CAR** > **Exterior lighting**.

### coming home

The coming home function lights up the area round the vehicle after dark when the ignition has been switched off and the driver's door opened. This function can be set to operate for a time interval between 0 (off) and 60 seconds. The coming home function is operational when the light switch is set to **AUTO**.

### leaving home

The leaving home function lights up the area round the vehicle after dark when the vehicle is unlocked. The function can be switched on or off as required. The leaving home function is operational when the light switch is set to **AUTO**.

### Automatic headlights\*

The sensitivity of the light sensor (i.e. how soon the lights are switched on) can be adjusted.

### Daytime running lights\*

The daytime running lights are switched **on** and **off** together with the ignition.

On vehicles for some markets the daytime running lights cannot be switched off if the vehicle has halogen headlights.

### Headlamp converter\* for driving abroad

The asymmetric low beams of the headlights are designed to light up the near side of the road more intensely. If you drive a right-hand drive vehicle in a left-hand drive country, or vice versa, you will dazzle oncoming traffic.

Vehicles with xenon headlights\*: The headlamp converter should be switched **on** to avoid dazzling oncoming traffic.

Vehicles with halogen headlights: Opaque stickers should be applied to certain parts of the headlight lenses. For further information, please consult an Audi dealer or other qualified workshop. ■

## Instrument lighting

*The background lighting of the instruments, the centre console and the display can be adjusted as required.*



Fig. 57 Instrument lighting

- Briefly press the knob to release it. ►

- Turn the button clockwise "+" to increase the brightness of the instrument lighting in dark conditions.
- Turn the button anti-clockwise "-" to reduce the brightness of the instrument lighting in dark conditions.
- Press the knob in again to prevent the setting from being changed unintentionally.

The instrument lighting (dials and needles), the centre console illumination and the illumination of the displays are regulated by a light sensor incorporated in the instrument cluster. In bright conditions any changes made to the brightness of the instrument lighting have no effect.

#### Note

The instrument lighting (illumination of dials and needles) is switched on when the ignition is on and the **vehicle's lights are off**. The instrument lighting is dimmed automatically as the daylight starts to fade; it is switched off completely when the light conditions become very poor. This function is intended to remind the driver to switch on the dipped-beam headlights in good time when light conditions become poor. ■

Applies to vehicles: with headlight range control

#### Headlight range control

*When the dipped beam headlights are switched on, the range of the headlights can be adjusted to suit the load being carried.*

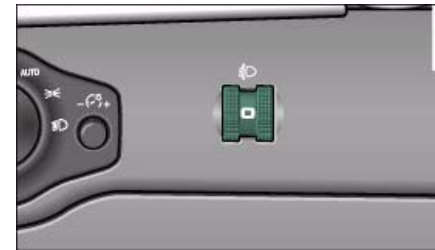







Fig. 58 Headlight range control

- Turn the thumbwheel  => fig. 58 to the appropriate setting.

#### Adjustment settings

The settings correspond roughly to the following load conditions:

-  I Two front occupants, luggage compartment empty
-  II All seats occupied, luggage compartment empty
-  III All seats occupied, luggage compartment loaded
-  IV Driver only, luggage compartment loaded

#### Caution

Always adjust the headlights to avoid dazzling oncoming traffic. Make sure you lower the headlights when the vehicle is carrying a heavy load. ■

Applies to vehicles: with xenon headlight bulbs

### Dynamic headlight range control

Headlights with xenon gas-discharge bulbs automatically adapt to suit the load being carried when the engine is switched on. The headlights are also automatically adjusted when the vehicle is in motion (e.g. when accelerating and braking). ■

Applies to vehicles: with adaptive light

### adaptive light

*This feature provides better illumination when you drive through a corner.*

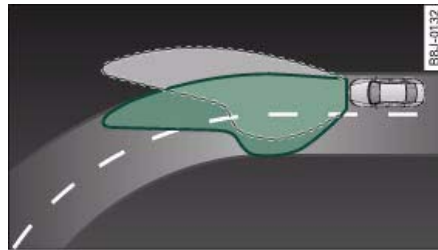

Fig. 59 adaptive light when driving

The adaptive light gives better illumination of the bend and the side of the road when driving through a corner ⇒ fig. 59. The adaptive light is controlled automatically, depending on the speed of the vehicle and the steering wheel angle.

The headlights are regulated automatically when you drive through a corner, depending on how far you turn the steering wheel. To avoid having a dark spot in front of the vehicle the two headlights are directed at different angles.

### Note

The system is active at speeds from approximately 10 km/h to 110 km/h. ■

### Hazard warning lights ▲

*The hazard warning lights are used to make other road users aware of your vehicle in hazardous situations.*



Fig. 60 Switch for hazard warning lights

- Press the switch ▲ to switch the hazard warning lights on or off ⇒ fig. 60.

All four turn signals flash simultaneously when the hazard warning lights are switched on. The two turn signal indicator lamps ⇄ and the indicator lamp in the switch ▲ will flash at the same time. The hazard warning lights also work when the ignition is switched off.

The hazard warning lights come on automatically in the event of an accident in which an airbag is triggered or in the case of an emergency stop (full brake application).

### Note

You should switch on the hazard warning lights to warn other road users, for instance: ►

- When reaching the tail end of a traffic jam
- If your vehicle breaks down or there is an emergency
- If your vehicle is being towed away, or if you are towing another vehicle. ■

### Turn signal and main beam lever

The turn signal and main beam lever also operates the parking lights and the headlight flasher.

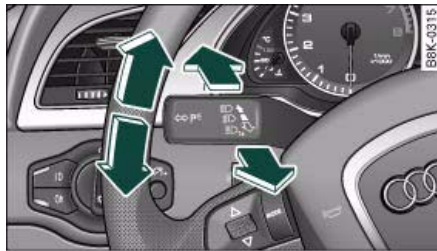

Fig. 61 Turn signal and main beam headlight lever

The turn signal and main beam headlight lever has the following functions:

#### Turn signals ⇄

- Move the lever all the way up to indicate right, or all the way down to indicate left ⇒ fig. 61.
- Move the lever briefly up or down just as far as the point of resistance and then release it: the turn signals will flash three times.
- Move the lever up or down just as far as the point of resistance and hold it there: the turn signals flash for as long as you hold the lever.

#### Main beam headlights ㊦

- Press the lever forward to switch on the main beams.
- Pull the lever back towards you to switch the main beam headlights off again.

#### Headlight flasher ㊦

- Pull the lever towards the steering wheel to operate the flasher.

#### Parking lights P<

- Switch off the ignition.
- Move the lever up or down to turn on the right or left-hand parking lights respectively.

#### Notes on these functions

- The *turn signals* only work when the ignition is switched on. The corresponding indicator lamp ⇄ or ⇄ flashes in the instrument cluster.
- The turn signals are cancelled automatically when the steering wheel is returned to the straight-ahead position.
- The *main beam headlights* can only be switched on if the dipped beam headlights are already on. The main beam headlight indicator lamp ㊦ then comes on in the instrument cluster.
- The *headlight flasher* comes on for as long as you pull the lever – even if no other lights are switched on. The main beam headlight indicator lamp ㊦ then comes on in the instrument cluster.
- When the *parking lights* are switched on, the headlight and the rear light on one side of the car light up with reduced intensity. The parking lights will only work with the ignition off. A warning buzzer will sound for as long as the driver's door is open. ►



### ! Caution

Do not use the main beam headlights or the headlight flasher if this would dazzle oncoming traffic. ■

## Interior lights

### Front interior lights

The front interior lighting also incorporates the reading lights for the driver and passenger.

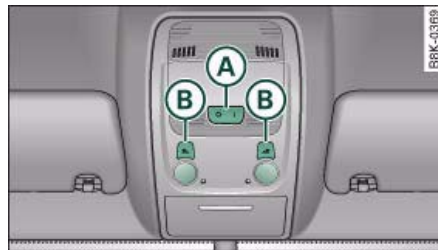

Fig. 62 Headliner: Front interior lighting/reading lights

The rocker switch (A) ⇒ fig. 62 for the interior light has the following functions:

#### Courtesy light position

- Move switch (A) to the centre position.

#### Interior light switched on

- Move switch (A) to position I.

#### Interior light switched off

- Move switch (A) to position O.

### Front reading lights

- Press one of the switches (B) ⇒ fig. 62 to switch the left or right reading light on and off.

If you switch on the courtesy lighting, the interior lights come on automatically when the vehicle is unlocked or the doors are opened. The light also comes on when the key is pulled out of the ignition. It goes out approximately 30 seconds after the doors are closed. The interior light is switched off immediately when the vehicle is locked or when the ignition is switched on.

If a door is left open, the light is switched off after about 10 minutes to prevent the battery from running flat.

The brightness of the light is automatically adjusted by a dimmer when it is switched on. ■

### Rear interior lights

Reading lights are also provided for rear passengers.

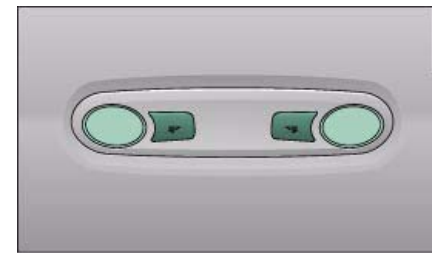



Fig. 63 Headliner: Rear reading lights

The reading lights are switched on and off with the switches . ■

## Clear vision

### Sun visors

The sun visors can improve visibility and contribute to safety.

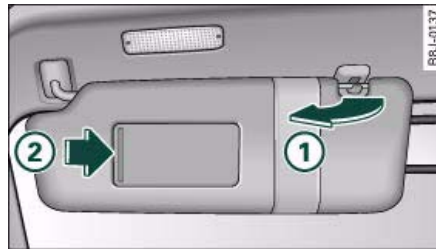

Fig. 64 Passenger's side: Sun visor

The sun visors for the driver and the front passenger can be pulled out of their mountings in the centre of the vehicle and turned towards the doors ⇒ fig. 64 ①. Once the sun visor has been turned towards the door you can pull it towards the rear as desired.

### Make-up mirrors

There are covers on the make-up mirrors in the sun visors. The light for the mirror (located in the headlining) comes on automatically when the mirror cover ② is slid open. The light switches itself off when the cover is closed and when the sun visor is pushed back up. ■

Applies to vehicles: with sun blinds

### Sun blinds

Sun blinds are provided for the rear window and the rear side windows.



Fig. 65 Switch for sun blind (vehicles with MMI)



Fig. 66 Switch for sun blind

### Sun blinds (rear side windows)

- Pull out the blind and hook it into the retainers at the top of the door frame.

### Sun blind (rear window)

- Press the switch  ⇒ fig. 65 or ⇒ fig. 66 to extend or retract the sun blind for the rear window. ►

- To retract the sun blind automatically when reversing, select: Function selector button **CAR** > **Windows** > **Automatic rear blind** > **on**.

If you switch the **Automatic rear blind** function **on** in the sound system or MMI\*, the raised sun blind will be retracted automatically when reverse gear is engaged ⇒ *page 55*. In this way, the rear blind will not obstruct your vision when reversing. The rear blind returns to its raised position when reverse gear is disengaged and the vehicle is driven forwards at a speed above about 15 km/h. The current setting is automatically stored and assigned to the remote control key.

If the rear blind was rolled in automatically when reversing and then the ignition was switched off and on again, the blind will *not* roll back out again when you select a forward gear and the speed exceeds 15 km/h. You will then have to press the button  on the centre console to extend the blind again.

The sun blind for the rear window switches off automatically when it reaches the end position. It can be made to move in the other direction before it reaches its end position by briefly pressing the switch a second time. If the ignition is turned off while the blind is still moving, it continues until it reaches the end position before switching off.

#### Note

- An overload cut-out may be activated if the sun blind is operated repeatedly. There will then be a short delay before the blind can be operated again.
- As the material of the sun blind is less flexible at low temperatures the electric actuator is switched off when the temperature in the car is below -5°C. The blind can only be operated when the temperature in the car's interior rises above this level. ■

## Windscreen wipers

### Windscreen wipers

The windscreen wiper lever controls the windscreen wipers and the automatic wash and wipe.



Fig. 67 Windscreen wiper lever

The windscreen wiper lever has the following settings:

#### Brief wipe

- Move the lever down to position **1** to give the windscreen a *brief* wipe.

#### Intermittent wipe (activating rain sensor)

- Move the lever up to the stop **2**.
- Move the control **A** to the left or right to set the sensitivity of the rain sensor.

#### Slow wiper speed

- Move the lever up to the stop **3**.

#### Fast wiper speed

- Move the lever up to the stop **4**.

**Automatic wash and wipe**

- Pull the lever to position ⑤.
- Release the lever again. The washer will stop and the wipers will keep running for approximately 4 seconds. The number of wipe cycles varies according to the length of time the lever is pulled.

**Switching off the wipers**

- Move the lever to the "off" position ①.

**General notes**

The washers and wipers will only work when the ignition is switched on.

If you stop briefly, e.g. at traffic lights, the wiper speed will automatically be reduced by one level.

The windscreen washer jets are heated when the ignition is switched on if the outside temperature is low.

**Dribble wipe**

About 5 seconds after the wash and wipe cycle has finished, the windscreen wiper system automatically gives the screen one extra wipe to remove any dribbles of water.

If you want to deactivate the dribble wipe function while driving, pull the lever to position ⑤ again within 10 seconds.

The dribble wipe function will be re-activated the next time the ignition is switched off and on.

**Rain sensor\***

The rain sensor will only function in the intermittent wipe position. The intermittent wipe function is activated automatically when it starts to rain.

Before you reach a road speed of 6 km/h you will have to activate the rain sensor manually by switching it off and back on again.

To reduce the sensitivity level of the rain sensor move control (A) ⇒ page 65, fig. 67 to the left. To increase the sensitivity level of the rain sensor move the control to the right.

If you have selected a high sensitivity level for the rain sensor the windscreen wipers will react sooner to any moisture on the windscreen. The wiper intervals in the intermittent wipe setting are also varied automatically according to the road speed (in addition to the sensitivity setting).

**! WARNING**

- **Poor visibility can cause accidents. Always ensure that the wiper blades are in good condition** ⇒ page 68, "Changing wiper blades".
- **The rain sensor is only intended to assist the driver. The driver is still obliged to manually operate the windscreen wipers as required depending on visibility.**
- **Do not use water-repellent coatings on the windscreen. In bad visibility conditions such as light rain, low sun or when driving at night these coatings can cause increased dazzle, which is a serious safety hazard. Such coatings can also cause the wiper blades to judder.**

**! Caution**

- In icy conditions, always check that the wiper blades are not frozen to the glass before using the wiper for the first time. If you switch on the wipers when the wiper blades are frozen to the glass, this could damage both the wiper blades and the wiper motor.
- Make sure you switch off the windscreen wiper system (lever in position "0") before you use an automatic car wash. This will avoid inadvertent triggering of the wipers and possible damage to the wiper system. ►

### Note

- Check that the washer fluid reservoir is full before starting a long journey. Filling the reservoir ⇒ *page 267*.
- Worn or dirty wiper blades can cause smearing on the glass which can also impair the effectiveness of the rain sensor. Please check the wiper blades regularly. ■

Applies to vehicles: with headlight washers

### Headlight washer system

The headlight washer system only operates when the lights are switched on.

- Move the automatic wash and wipe lever to position ⑤ ⇒ *page 65*, fig. 67.

The headlight washer system is always activated the first time you operate the automatic wash and wipe. Subsequently, it is only activated about every five wash and wipe cycles. The headlights are always washed if you hold the lever for longer than about 2 seconds.

The headlight washer jets come out of the bumper automatically (under water pressure).

Clean off stubborn dirt (insects, etc.) from the lenses at regular intervals, for instance when stopping for fuel.

To ensure that the system works properly in winter, keep the nozzle holders free of snow and remove any ice with a de-icer spray. ■

### Service position

Use the service position to change the wiper blades.



Fig. 68 Display: Windscreen wipers

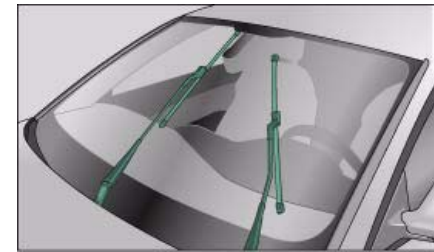

Fig. 69 Service position

You can set the wipers to the service position on the sound system or MMI\*.

- If the wiper blades are not frozen to the windscreen, move the windscreen wiper lever to the "off" position ① ⇒ *page 65*, fig. 67.
- Select: Function selector button **[CAR]** > **Windscreen wipers** > **Service position** ⇒ fig. 68.
- **on** - the wiper blades can only be replaced when the wiper arms are in the service position ⇒ fig. 69. If you only work on the wipers ►

when they are in the service position you will also avoid damaging the paintwork on the bonnet.

- **off** - the windscreen wipers will be moved back to their original position.

### ⚠ Caution

Never move the vehicle with the front wiper arms in a raised position as they are automatically moved back to their normal park position above a speed of 6 km/h. The paintwork on the bonnet may be damaged as a result.

### i Note

- You can also use the service position, for example, if you want to fix a cover over the windscreen in the winter to keep it clear of ice.
- The service position is automatically set to **off** when you operate the windscreen wiper lever or the road speed exceeds 6 km/h. ■

## Changing wiper blades

*Good wiper blades are essential for clear vision.*

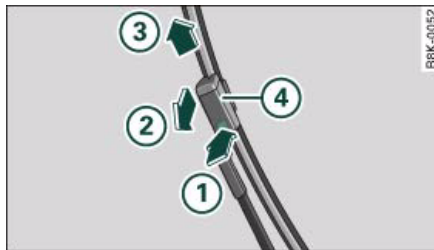

Fig. 70 Removing the wiper blades

### Taking off the wiper blade

- Set the wipers to the service position ⇒ *page 67*.

- Lift the wiper arm away from the glass.
- Press the release button ① on the wiper blade ⇒ *fig. 70*. Hold the wiper blade firmly and press it forwards slightly ②.
- Slide the wiper blade upwards ③.

### Fitting the wiper blade

- Fit the new wiper blade into the mounting on the wiper arm ④. You should hear it engage in the wiper arm.
- Fold the wiper arm back down onto the glass.

### ⚠ WARNING

- **To prevent smearing on the glass, the wiper blades should be cleaned regularly using a window cleaner solution. If the wiper blades are very dirty (insects etc.), they should be cleaned using a sponge or cloth – bad visibility can cause accidents.**
- **For safety, the wiper blades should be changed once or twice a year.**

### ⚠ Caution

The windscreen wipers must be in the service position ⇒ *page 67* when replacing the blades! Otherwise the wiper motor or the paintwork on the bonnet may be damaged. ■

## Rear-view mirrors

### Manual anti-dazzle adjustment

#### Normal setting

- Push the lever at the bottom of the mirror away from you. ▶

### Anti-dazzle setting

- Pull the lever at the bottom of the mirror towards you. ■

Applies to vehicles: with automatic anti-dazzle adjustment for interior mirror

### Automatic anti-dazzle adjustment

The automatic anti-dazzle function can be switched on and off as desired.

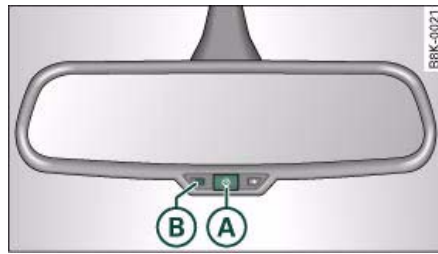

Fig. 71 Anti-dazzle interior mirror: On/off button with indicator lamp

### Switching off anti-dazzle function

- Press button (A) ⇒ fig. 71 - the indicator lamp (B) will go out.

### Switching on anti-dazzle function

- Press button (A) - the indicator lamp (B) will light up.

### Anti-dazzle function

The anti-dazzle function is activated every time the ignition is switched on. The green indicator lamp lights up in the mirror housing.

When the anti-dazzle function is activated the interior mirror will darken *automatically* according to the amount of light it receives (for example from the headlights of a vehicle behind). The mirror will **not** darken automatically:

- when the interior lighting is switched on
- when reverse gear is engaged

### WARNING

Electrolyte fluid can leak from a broken mirror. This fluid can cause irritation to the skin, eyes, and respiratory organs. Wash thoroughly with clean water should you come into contact with this fluid. Seek medical assistance if needed.

### Caution

Electrolyte fluid leaking from a broken mirror can cause damage to plastic surfaces. Use a sponge or similar to remove the fluid as soon as possible.

### Note

- If you switch off the anti-dazzle function for the interior mirror, this will also deactivate the anti-dazzle function for the exterior mirrors.
- The automatic anti-dazzle function will only work properly if the sun blind\* for the rear window is not in use and there are no other objects preventing light from reaching the interior mirror.
- Do not attach any stickers to the windscreen in front of the sensors, as these could lead to malfunctioning of the mirror. ■

## Exterior mirrors

The exterior mirrors are adjusted electrically.

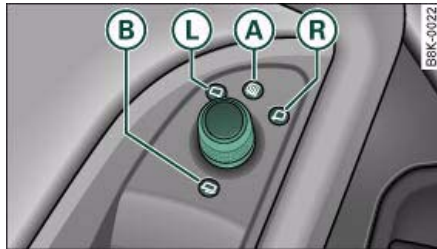

Fig. 72 Detail of the armrest: Adjuster knob

### Adjusting exterior mirrors

- Turn the adjuster knob to position **L** (left exterior mirror) or position **R** (right exterior mirror) ⇒ fig. 72.
- Move the knob as required to adjust the exterior mirror for a good rearward view.

### Heated mirrors

- Turn the knob to position **A**.

### Retracting both exterior mirrors\*

- Turn the knob to position **B**.

The mirrors are heated depending on the outside temperature until the ignition is switched off, even if the knob is no longer in position **A**.

It may be advisable to retract\* the exterior mirrors to protect them when parking or when driving through tight spaces.

### Memory for exterior mirrors\*

On vehicles with memory function for the driver's seat, the setting of the exterior mirrors is automatically stored together with the seat position ⇒ page 75.

### Tilting function for exterior mirror on passenger side\* (only if equipped with memory for exterior mirrors)

When reverse gear is engaged, the mirror surface tilts slightly downwards, provided the mirror control is switched to the exterior mirror on the passenger's side (knob in position **R**) ⇒ fig. 72). This provides a better view of the kerb when parking.

The mirror returns to its original position when reverse gear is disengaged and the vehicle is driven forwards at a speed above about 15 km/h. The mirror will also return to its original position when the adjuster knob is turned to the position for the driver's exterior mirror **L** or when the ignition is switched off.

If the position of the mirror surface is changed while the mirror is tilted, this new position is automatically stored and assigned to the remote control key when you disengage reverse gear.

### ! Caution

- Convex or wide-angle\* exterior mirrors give a larger field of vision. However, they also make objects appear further away than they actually are. For this reason, you should not rely on these mirrors for judging the distance of vehicles behind.
- If one of the mirror housings is knocked out of position (e.g. when parking), the mirrors must first be fully retracted with the electric control. Do not readjust the mirror housing by hand, as this will interfere with the mirror adjuster function.

### i Note

If the electrical adjustment should ever fail to operate, the mirrors can be adjusted by hand by lightly pressing the edge of the mirror glass. ■



Applies to vehicles: with automatic anti-dazzle adjustment for exterior mirrors

### Automatic anti-dazzle adjustment for exterior mirrors

The exterior mirrors darken together with the automatically adjusting interior mirror. When the ignition is on, the mirrors will darken automatically according to the amount of light received (for example from the headlights of a vehicle behind).

When the interior lights are switched on, or when reverse gear is engaged, the mirrors revert to their original (i.e. not darkened) condition.

#### WARNING

Electrolyte fluid can leak from a broken mirror. This fluid can cause irritation to the skin, eyes, and respiratory organs. Wash thoroughly with clean water should you come into contact with this fluid. Seek medical assistance if needed.

#### Caution

Electrolyte fluid leaking from a broken mirror can cause damage to the paintwork or plastic surfaces. Use a sponge or similar to remove the fluid as soon as possible.

#### Note

- If you switch off the anti-dazzle function for the interior mirror, this will also deactivate the anti-dazzle function for the exterior mirrors.
- The automatic anti-dazzle function will only work properly if the sun blind\* for the rear window is not in use and there are no other objects preventing light from reaching the interior mirror. ■

## Digital compass

Applies to vehicles: with digital compass

### Activating and deactivating the compass

*The compass direction will appear in the mirror.*

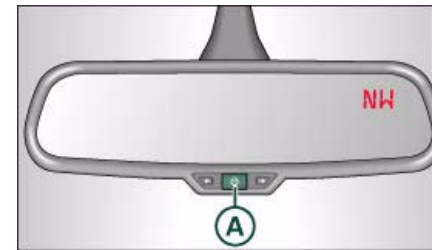



Fig. 73 Interior mirror: activated digital compass

- To switch the compass on and off, press and hold button  until the compass display in the mirror ⇒ fig. 73 appears or disappears.

The digital compass only works when the ignition is on. The points of the compass are displayed as follows: **N** (North), **NE** (North East), **E** (East), **SE** (South East), **S** (South), **SW** (South West), **W** (West), **NW** (North West).

#### Note

To avoid inaccurate compass readings, do not hold any remote controls or other electrical devices or metal objects near the interior mirror. ■

Applies to vehicles: with digital compass

### Setting the correct compass calibration zone

*The correct compass calibration zone must first be set before the compass can give an accurate reading.*

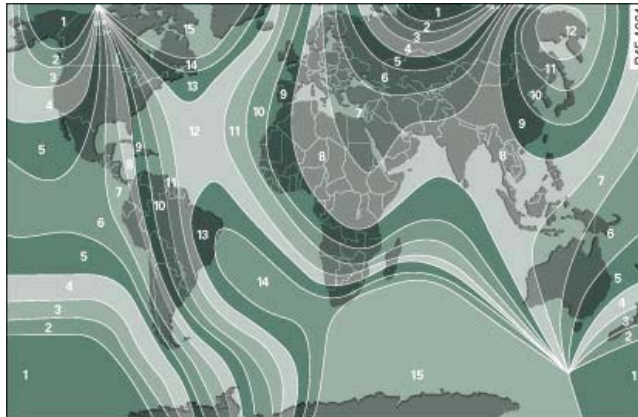

Fig. 74 Map of compass calibration zones

- Press and hold button **(A)** ⇒ page 71, fig. 73 until the currently set zone number is displayed on the interior mirror.
- Press button **(A)** repeatedly until the correct zone number appears. The adjustment mode will be ended automatically after a few seconds. ■

Applies to vehicles: with digital compass

### Calibrating compass

*The compass must be re-calibrated if the display is incorrect or inaccurate.*

- Press and hold button **(A)** until the letter **C** appears in the interior mirror.
- Drive in a circle at a speed of about 10 km/h until a point of the compass is displayed in the interior mirror.

#### **WARNING**

**Calibrate your compass at a location where there is no traffic so that you do not endanger yourself or other road users (accident risk). ■**

## Seats and storage

### Manual adjustment of front seats

Applies to vehicles: with manual seat adjustment

#### Seat adjuster controls

There are several seat adjustment functions for your comfort and convenience

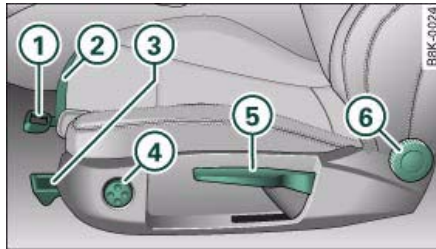

Fig. 75 Adjuster controls on driver's seat

Some of the controls shown are only fitted on certain models or are optional extras.

#### Adjuster controls

- ① Moves seat backwards or forwards
- ② Thigh support\*
- ③ Adjusts angle of seat cushion\*
- ④ Adjusts lumbar support\*
- ⑤ Adjusts seat height
- ⑥ Adjusts backrest angle ■

Applies to vehicles: with manual seat adjustment

#### Seat adjustment

*It is possible to adjust the position and shape of the seat manually so that you can travel in a safe and comfortable sitting position.*

Before adjusting your seat, please read and observe the warnings ⇒ .

#### Moving seat backwards or forwards

- Lift the lever ① ⇒ fig. 75 and move the seat to the desired position.
- Then release the lever ① and move the seat further until the catch engages.

#### Extending or shortening the thigh support\*

- Lift the control ② below the seat cushion. The front seat cushion will spring forward.
- Slide the seat cushion back to the normal position after each use.

#### Adjusting angle of seat cushion\*

- Pull the lever ③ ⇒ fig. 75 up or down repeatedly (i.e. pump the lever).

#### Adjusting contour of lumbar support\*

- Press the front or rear part of the adjuster switch ④ to increase or decrease the curvature of the lumbar support as required. ▶

**Adjusting height of lumbar support\***

- Press the top or bottom part of the adjuster switch (4) to move the lumbar support upwards or downwards as required.

**Raising or lowering the seat**

- Pull the lever (5) ⇒ page 73, fig. 75 up or down repeatedly (i.e. pump the lever).

**Adjusting backrest angle**

- Lean forwards to take your weight off the backrest.
- Turn the adjuster wheel (6) ⇒ page 73, fig. 75 to set the angle of the backrest as required.

**! WARNING**

- **Never adjust the driver's seat when the vehicle is moving - this could lead to an accident.**
- **Be careful when adjusting the seat height. Careless or uncontrolled use of the seat adjustment can cause injuries.**
- **Do not drive with the backrests of the front seats reclined too far as otherwise the seat belt and airbag could fail to restrain the wearer properly in an accident, possibly leading to injury. ■**

**Electric adjustment of front seats****Seat adjuster controls**

*The arrangement of the switches corresponds with the design of the seats.*

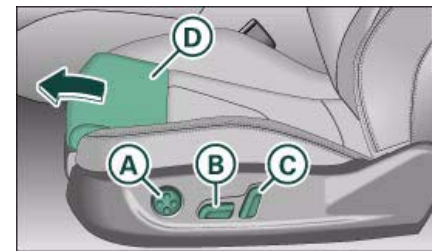

**Fig. 76 Front seat: Adjuster controls**

The adjustment switches for the seat and backrest correspond with the design of the seat. The seats can be adjusted simply by pressing the corresponding switch in the required direction.

**Adjuster controls**

- (A) Lumbar support
- (B) Seat adjuster
- (C) Backrest adjuster
- (D) Thigh support\* ■

**Seat adjustment**

*You can use the electrical adjustment to set the position, angle and shape of the seat so that you can travel in a safe and comfortable sitting position.*

Before adjusting your seat, please read and observe the warnings ⇒ !.

### Adjusting contour of lumbar support

- Press the front or rear of switch (A) to increase or decrease the curvature of the lumbar support as required.

### Adjusting height of lumbar support

- Press the top or bottom of adjuster switch (A) to move the lumbar support upwards or downwards as required.

### Moving seat backwards or forwards

- Press switch (B) ⇒ page 74, fig. 76 forwards or backwards.

### Adjusting seat height

- Press switch (B) up or down.

### Raising/lowering seat at front

- Press the front of switch (B) up or down.

### Raising/lowering seat at rear

- Press the rear of switch (B) up or down.

### Adjusting backrest angle

- Press switch (C) forwards or backwards.

### Extending or shortening the thigh support\*

- Lift the control (D) below the seat cushion. The front seat cushion will spring forward.
- Slide the seat cushion back to the normal position after each use.

### WARNING

- Never adjust the driver's seat when the vehicle is moving - this could lead to an accident.
- The electrical seat adjustment also works when the ignition is off and when the key is not in the ignition. To avoid accidental injuries, never leave children unattended in the vehicle.
- Be careful when adjusting the seat height. Careless or uncontrolled use of the height adjustment can cause injuries.
- Do not drive with the backrests of the front seats reclined too far as otherwise the seat belt and airbag could fail to restrain the wearer properly in an accident, possibly leading to injury. ■

## Seat memory

### Memory for driver's seat

You can use the recall buttons in the driver's door to store and recall the seat adjustments for two drivers.

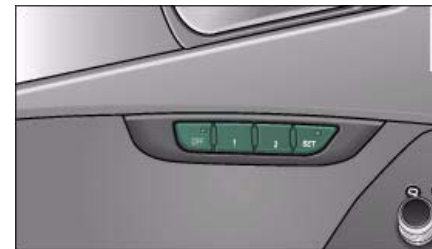

Fig. 77 Driver's door:  
Seat memory

As well as the driver's seat position, the seat memory will store and recall the exterior mirror settings (if the vehicle is equipped accordingly):

**Storing and recalling settings**

You can store and recall the settings for two different drivers using the recall buttons 1 and 2 ⇒ *page 75*, *fig. 77* ⇒ *page 76*.

In addition, the current settings are automatically stored when you lock the vehicle and assigned to the remote control key that is being used. When you unlock the vehicle, the system automatically recalls the settings stored on that remote control key.

**Switching seat memory on and off**

The seat memory will be out of action if the **OFF** switch has been pressed and the diode in the switch is lit. In this case, the setting cannot be stored.

The stored settings will all remain in the memory. However, the seat can now only be adjusted using the conventional electrical adjustment. ■

Applies to vehicles: with seat memory

**Storing and recalling settings****Storing settings**

- Adjust the driver's seat as required.
- Adjust both exterior mirrors.
- Press the **SET** button. The diode in the switch will light up to indicate that it is ready to store the settings. Now press the desired recall button for at least a second.
- Release the button. The setting is now stored on the selected recall button.

**Recalling settings**

- If the driver's door is open, press the desired recall button briefly.

- If the driver's door is closed, press and hold down the desired recall button until the programmed settings are reached.

A tone will sound and the diode in the **SET** button ⇒ *page 75*, *fig. 77* will light up to confirm that the settings have been stored.

When you **lock** the vehicle the current settings are automatically stored and assigned to the remote control key. However, the settings assigned to the remote control key will not overwrite the settings stored on recall buttons 1 and 2. The settings stored on the recall buttons can be called up at any time. When you **unlock** the vehicle, the settings assigned to the remote control key are recalled automatically.

If your vehicle is also driven by other persons using your remote control key, it is advisable to store your personal settings on one of the recall buttons. You can then recall your own settings at any time simply by pressing the corresponding recall button. When you lock the vehicle these settings are then stored automatically and assigned once again to the remote control key.

**! WARNING**

- For safety reasons, never recall seat settings when the vehicle is moving - this could lead to an accident.
- In an emergency the recall function can be stopped at any time by pressing the **ON/OFF** switch, or by briefly pressing any of the recall buttons. ■

Applies to vehicles: with seat memory

### Activating memory for remote control key

The relevant function must be activated on the sound system or MMI\* so that the settings stored in the memory can be recalled using the remote control key.



Fig. 78 Display: Driver's seat

- Select: Function selector button **CAR** > **Seat adjustment** > **Driver's seat** > **Remote control key** > on. ■

## Head restraints

### Adjusting the front head restraints

In combination with properly worn seat belts, the head restraints offer effective protection. However, they must always be properly adjusted to suit the height of the occupant.

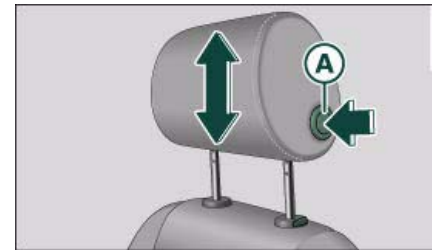

Fig. 79 Front seat: Adjusting head restraint

#### Raising head restraint

- Take hold of the sides of the head restraint with both hands.
- Push the head restraint upwards.

#### Lowering head restraint

- Take hold of the sides of the head restraint.
- Press button **A** ⇒ fig. 79 and push the head restraint downwards.

For best protection, the top of the head restraint should be at least at eye level, or higher.

The height of the head restraints is adjustable. They should be set to suit the height of the occupant. In combination with the seat ►

belts, the head restraints offer effective protection, provided they are properly adjusted. ■

### Adjusting the rear head restraints

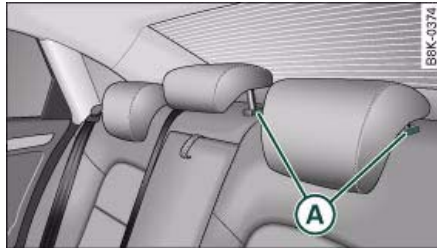

Fig. 80 Rear seats: Head restraint

#### Raising head restraint

- Take hold of the sides of the head restraint with both hands.
- Push the head restraint upwards as far as it will go.

#### Lowering head restraint

- Take hold of the sides of the head restraint.
- Press the button (A) ⇒ fig. 80 and push the head restraint downwards.

For best protection, the top of the head restraint should be at least at eye level, or higher.

When the rear seats are not occupied the head restraints should be moved to the lowest position so that they do not obstruct the driver's field of vision. ■

Applies to vehicles: with front armrest

### Front armrest

*The armrest can be adjusted to several positions and moved back and forwards.*

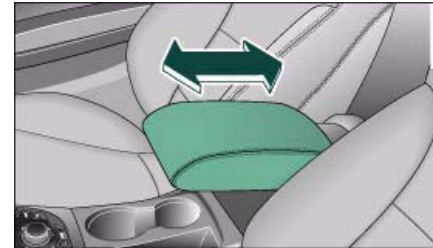

Fig. 81 Armrest between driver's seat and front passenger's seat

#### Adjusting armrest

- To adjust the position of the armrest, pull the armrest all the way down.
- Then lift the armrest gradually until it engages in the desired position.

#### Moving armrest

- You can move the armrest backwards or forwards ⇒ fig. 81.

Please note that the armrest can restrict the driver's movements when it is lowered. The armrest should therefore be moved back before driving in city traffic.

There is a storage compartment underneath the armrest. ■



## Luggage compartment

### Loading the luggage compartment

*Loads in the luggage compartment should be safely secured.*

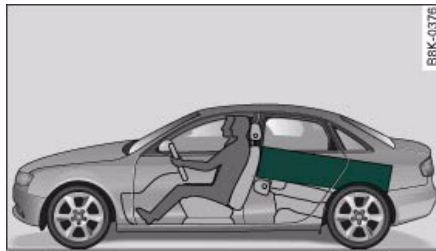

Fig. 82 Heavy items should be placed as far forwards as possible.

To maintain safe handling on the road, please observe the following points:

- Distribute the weight as evenly as possible.
- Position heavy items as far forward as possible ⇒ fig. 82.
- Secure the load with the luggage net\* or with non-elastic straps secured to the fastening rings\* ⇒ page 79.

#### **! WARNING**

- Unsecured objects in the luggage compartment can suddenly shift and cause changes in the handling of the vehicle.
- In an accident or a sudden manoeuvre, loose objects in the passenger compartment can be flung forward and possibly injure vehicle occupants.

#### **! WARNING (continued)**

- Always store objects in the luggage compartment and secure with suitable straps. This is especially important for heavy objects.
- When you transport heavy objects, always keep in mind that a change of the centre of gravity can also cause changes in vehicle handling.
- Please observe the important safety warnings ⇒ page 186, "Safe driving".

#### **i Note**

Adjust the tyre pressure to match the vehicle loading - the correct pressures are specified on the sticker on the end face of the driver's door. ■

Applies to vehicles: with fastening rings

### Fastening rings

*There are four fastening rings in the luggage compartment which can be used to secure loads.*

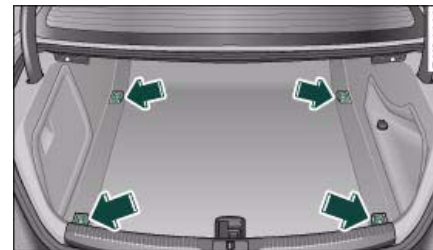

Fig. 83 Location of fastening rings in luggage compartment

- Use the fastening rings to secure the load ⇒ fig. 83 -arrows-.

- Please refer to the safety notes ⇒ *page 193*. ■

Applies to vehicles: with stretch net

### Stretch net / retaining net

*The stretch net / retaining net can be used to secure light items in the luggage compartment.*



Fig. 84 Stretch net laid out



Fig. 85 Stretch net attached in position as retaining net

### Stretch net

- First secure the *front* hooks in the fastening rings ⇒ *fig. 84*.
- Then secure the *rear* hooks in the fastening rings.

### Retaining net

- Secure the hooks of the retaining net to the fastening rings at the bottom of the tail panel ⇒ *fig. 85*.
- Pull down the retaining hooks at the top of the luggage compartment. Pull up the net and attach the loops of the net to the retaining hooks.

You can also use the retaining hooks ⇒ *fig. 85* to secure light items of luggage, such as shopping bags, etc.

The hooks will fold up again by themselves when not in use.

### ! WARNING

The retaining net should only be used to hold objects weighing up to 5 kg. Heavier objects cannot be safely secured (injury risk). ■

### Side storage compartment

*The DVD player for the navigation system\* is located in the left side compartment in the luggage compartment.*



Fig. 86 Luggage compartment: Side trim with closed storage compartment ►

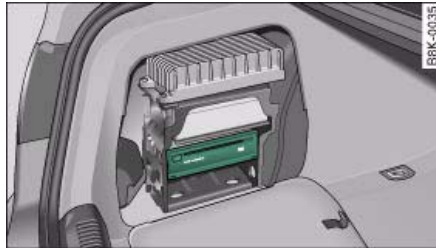

**Fig. 87 Luggage compartment: DVD player for navigation system**

- To open the storage compartment, pull the handle ⇒ *page 80*, fig. 86.

#### DVD player for navigation system\*

The DVD player for the navigation system is located in this storage compartment ⇒ fig. 87 in the luggage compartment. For more information, please refer to the Infotainment/MMI Operating Manual. ■

#### Extending the luggage compartment

*The two sections of the backrest can be folded forwards either together or separately to increase the capacity of the luggage compartment.*

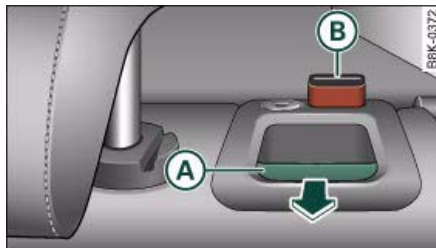

**Fig. 88 Backrest release lever**

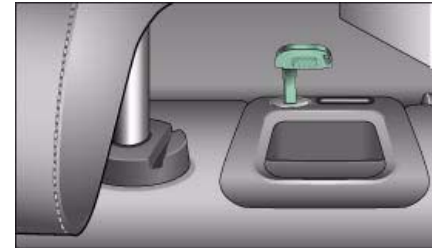

**Fig. 89 Locking the backrest**

#### Folding down backrest

- Press the release lever (A) ⇒ fig. 88 in the direction indicated (arrow).
- Fold down the backrest.

#### Returning backrest to an upright position

- Push the backrest up until it engages securely ⇒ ⚠. The red marking on the tab (B) should no longer be visible when the backrest is properly secured.

When the backrest is properly engaged in its upright position, it can be locked and unlocked with the key ⇒ fig. 89. This prevents unauthorised access to the luggage compartment from inside the vehicle.

#### ⚠ WARNING

- Make sure that the rear backrest is securely locked in position so that the seat belt can provide proper protection on the centre rear seat.
- The rear backrest must always be securely latched so that objects stored in the luggage compartment will not fly forward during sudden braking.

**⚠ Caution**

When returning the backrest to an upright position, make sure that the seat belts for the outer rear seats are in their guides so that they cannot be caught up and damaged in the catches for the backrest. ■

**Storage shelf**

The storage shelf behind the rear backrest should only be used to store light articles of clothing.

**⚠ WARNING**

Do not store any heavy or hard objects on the storage shelf. They could cause injury if the brakes are applied suddenly.

**⚠ Caution**

Please note that hard objects could chafe against the wires of the heating element in the rear window and cause damage.

**i Note**

Make sure that the slots between the rear window and the storage shelf are kept clear to ensure unimpaired ventilation. ■

Applies to vehicles: with load-through hatch

**Load-through hatch with transport bag**

You can use the load-through hatch and the removable ski bag to transport skis or other extra-long objects safely inside the vehicle without soiling or damaging the upholstery.



Fig. 90 Rear seat:  
Cover of load-through  
hatch

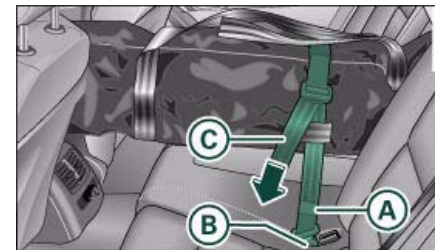





Fig. 91 Securing the  
ski bag with the centre  
seat belt buckle on the  
rear seat

**Loading**

- In the passenger compartment, pull down the centre rear armrest.
- You will then see the inside cover of the load-through hatch - pull the release catch downwards ⇒ fig. 90 -arrow- to fold the hatch down. ▶

- Open the boot lid.
- Open out the ski bag and fill it with the items you wish to transport.
- Push the ski bag from the luggage compartment into the passenger compartment through the opening in the backrest ⇒ .

#### Securing

- Insert the fastening belt  ⇒ page 82, fig. 91 of the ski bag into the centre seat belt buckle .
- Pull the free end of belt  to tighten.

#### Storage

- Pull the ski bag towards the rear through the opening in the backrest.
- Close the cover of the load-through hatch in the passenger compartment.
- Fold up the ski bag.

#### WARNING

The ski bag must be secured in place with the fastening belt after it has been loaded.

#### Note

Allow the ski bag to dry before folding it up. ■

## Roof carrier

Applies to vehicles: with roof carrier: Under development at the time of print

### Description

*Additional loads can be transported using the roof carrier.*

Note the following points if you intend to carry loads on the roof:

- The rain channels are moulded into the roof as part of the aerodynamic roof design. It is therefore not possible to mount conventional roof luggage racks. We recommend using the carrier units from the range of Audi Genuine accessories.
- These carrier units form the basic elements of a complete roof carrier system. Special fixtures must then be added in order to safely transport luggage, bicycles, skis, surf boards or boats on the roof. All the elements of this system are available from Audi dealers.

### Caution

Any damage to the vehicle caused by the use of other types of roof rack or incorrect installation will not be covered by the factory warranty. The roof carrier system must therefore be installed exactly according to the instructions provided. ■

### Attachment points

The roof carrier must be attached at the marked points only.

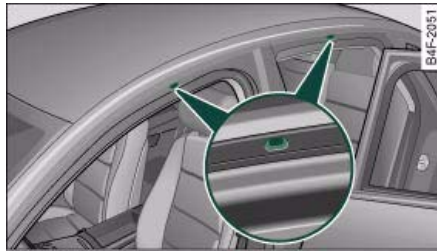

Fig. 92 Attachment points for carrier units

### Mounting

The feet of the roof carrier must always be attached at the position where the holes in the roof frame are located ⇒ fig. 92. The holes are only visible when the doors are open. When using roof carriers with pins, make sure that the pins are securely fixed in the holes when mounting the carrier units.

#### WARNING

After driving a few kilometres, check that the roof carrier is securely attached.

#### Note

Each roof carrier has a marking to indicate whether it is to be fitted at the front or rear of the vehicle. ■

### Roof load

Loads carried on the roof must be securely attached. The car's handling is affected when transporting loads.

The maximum permissible roof load for your vehicle is **90 kg**. The load limit applies to the combined weight of the carrier system and the load itself.

It will not be possible to carry the full maximum load if the roof carrier you are using is rated for a load which is less than this figure. Do not exceed the maximum weight limit for the roof carrier, which is listed in the fitting instructions.

#### WARNING

- To prevent accidents, loads carried on the roof must be securely attached.
- Do not exceed the maximum roof load for the vehicle, the maximum axle loads or the maximum gross vehicle weight, as this could cause an accident.
- When transporting heavy or bulky loads on the roof, bear in mind that the car's handling is affected by the extra weight on the roof and a possible susceptibility to cross winds. Adjust your speed and driving style accordingly to avoid accidents.

#### For the sake of the environment

The increased air resistance when the roof carrier is fitted means that the vehicle uses more fuel. For this reason you should always take off the roof carrier when it is not in use. ■

## Cup holders

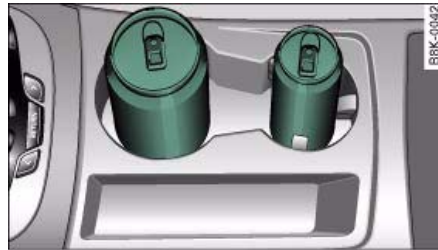

Fig. 93 Centre console:  
Front cup holder

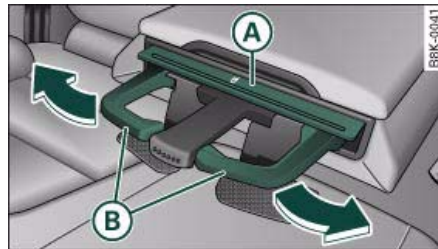



Fig. 94 Cup holder in  
rear armrest

### Front cup holder

- Two drinks can be placed in this cup holder ⇒ fig. 93.

### Opening rear cup holder

- Press the symbol  (A) ⇒ fig. 94.

### Placing drinks in rear cup holder

- To adjust the arm of the cup holder (B), move it in the direction indicated by the arrow.

- Position the cup in the holder and let go of the arm. The arm will move back automatically to secure the cup.

### Closing cup holder

- Press the middle piece between the two arms and push the cup holder back into the shaft as far as it will go.

The retainer arm should be positioned against the drinks container so that it is held securely.

One or two drink containers can be held in the centre armrest.

### WARNING

- Do not put any hot drinks in the cup holders while the vehicle is moving. You could be scalded if the hot liquid is spilt.
- Do not use hard china cups or glasses. These could cause injury in the event of an accident.

### Caution

You should avoid putting open drinks containers in the cup holders. The drinks could otherwise spill over and cause damage to e.g. the electrical equipment or the seat covers. ■

## Ashtrays

### Front ashtray

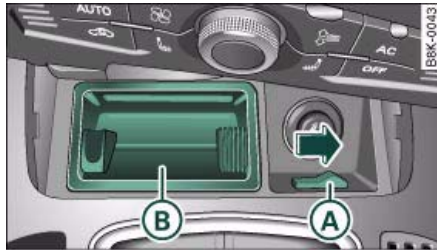

Fig. 95 Centre console:  
Ashtray open

#### Opening ashtray

- Slide the cover open.

#### Closing ashtray

- Lightly press the cover to make the ashtray close automatically.

#### Removing ashtray

- Slide the switch (A) ⇒ fig. 95 to the right to release the ashtray.
- Take out the ashtray (B) ⇒ fig. 95.

#### Inserting ashtray

- Insert the ashtray and press it into its mountings.

**! WARNING**  
Never put waste paper in the ashtray, as this could cause a fire. ■

### Rear ashtray

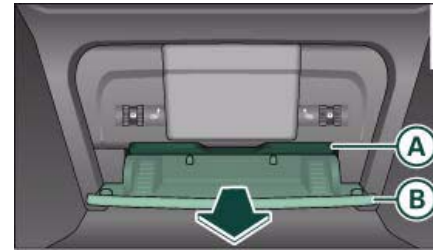

Fig. 96 Rear centre  
console: Ashtray

#### Opening ashtray

- Pull the front lip of the ashtray (B) ⇒ fig. 96 in the direction of the arrow.

#### Removing ashtray

- Press down the retainer (A) and take out the ashtray.

#### Inserting ashtray

- Place the ashtray in the holder.

**! WARNING**  
Never put waste paper in the ashtray, as this could cause a fire. ■



## Cigarette lighter and electrical sockets

### Cigarette lighter



Fig. 97 Front ashtray (open)

#### Using cigarette lighter

- Open the cover of the front ashtray.
- Press in the cigarette lighter knob.
- Wait for the lighter to spring out.
- Pull out the cigarette lighter immediately.
- Use the glowing heater element of the cigarette lighter to light your cigarette.
- Put the cigarette lighter back in its socket.

#### Operating electrical socket

- Take out the cigarette lighter.
- Insert the plug of the electrical appliance into the cigarette lighter socket.

The cigarette lighter employs a standard 12 Volt socket which can also be used as a power source for electrical appliances. The appliances connected to the socket must not exceed a power rating of 100 W.

The cigarette lighter only works when the ignition is on.

#### WARNING

- Take care when using the cigarette lighter. Carelessness or negligence when using the cigarette lighter can cause burns.
- The electrical sockets and any appliances connected to them will operate only when the ignition is switched on. Improper use of the electrical sockets or the appliances connected to them can cause injuries or fire. To avoid the risk of injury, never leave children unsupervised in the vehicle with the key.

#### Caution

- Always use the correct type of plugs to avoid damaging the sockets.
- The cigarette lighter socket should only be used for a short period of time as a power source for electrical equipment. Please use the electrical sockets\* ⇒ page 88 in the vehicle when connecting equipment for longer periods.

#### Note

Using electrical appliances with the engine switched off will drain the battery. ■

Applies to vehicles: with 12 Volt sockets

### 12 Volt sockets

*Electrical equipment can be connected to both 12 Volt sockets.*



Fig. 98 Detail of the side trim in the luggage compartment: 12 Volt socket



Fig. 99 Electrical socket in the centre console

#### Electrical socket in luggage compartment and front centre console

- Open the cover cap concealing the socket ⇒ fig. 98.
- Insert the plug of the electrical appliance into the socket.

#### Electrical socket in rear centre console

- Fold up the lid ⇒ *page 89*, fig. 100 to access the socket.

- Insert the plug of the electrical appliance into the socket.

Electrical equipment can be connected to the 12 Volt socket. The appliances connected to the socket must not exceed a power rating of 150 W.

#### WARNING

**The electrical sockets and any appliances connected to them will operate only when the ignition is switched on. Improper use of the electrical sockets or the appliances connected to them can cause injuries or fire. To avoid the risk of injury, never leave children unsupervised in the vehicle with the key.**

#### Caution

- To avoid damage to the vehicle's electrical system, never connect equipment that generates electrical current, such as a solar panel or battery charger, to the 12 Volt sockets or cigarette lighter in order to charge the vehicle's battery.
- Use only equipment which has been tested for electromagnetic compatibility in compliance with EC Directive 2004/104/EC.

#### Note

Using electrical appliances with the engine switched off will drain the battery. ■

Applies to vehicles: with 230 Volt Euro socket

## On-board 230 Volt Euro socket

*Electrical equipment can be connected to the 230 Volt Euro socket in the rear centre console.*



Fig. 100 Rear centre console: 230 Volt Euro socket

The 230 Volt Euro socket can only be used when the ignition is on ⇒ .

- Fold up the lid to access the socket.
- Plug the Euro connector into the socket. This will automatically release the child safety device.

### LED in electrical socket

<b>Steady green light:</b>	The socket is ready for use.
<b>Flashing red light:</b>	The socket has tripped out due to a power surge, overheating or similar

### Appliances suitable for connection

Electrical equipment with a Euro plug connector can be connected to the 230 Volt Euro socket. The appliances connected to the 230 Volt Euro socket must not exceed a power rating of 150 W (300 W peak power).

If you connect more than one appliance, the total power rating of all appliances must not exceed 150 W. If necessary, check the type plates on the connected appliances for details of the power ratings.

Connected appliances must be in perfect condition and free of defects.

### WARNING

- Heavy appliances or plugs (such as power supply units) can damage the mounting of the 230 Volt Euro socket if they are suspended directly from the socket – Risk of injury!
- Make sure that all connected appliances are securely stowed when driving to prevent them from being catapulted through the car under braking or in an accident – Danger to life!
- Never spill liquid over the socket – Danger to life! If the socket does get wet, ensure that it is absolutely dry before using it again.
- Improper use of the electrical socket or appliances connected to it can cause injuries or fire – Risk of injury!
- Never leave children unattended in the vehicle while the engine is running – Risk of injury!
- Connected appliances behave differently than when they are connected to the public electricity grid. As a result, the connected appliances may become hot during operation – Risk of injury!
- When using adapters or extension cables, please remember that the child safety device on the 230 Volt Euro socket is deactivated and the socket is live – Risk of injury!
- Do not insert conductive materials, such as knitting needles, into the contacts of the 230 Volt Euro socket – Danger to life!
- Switch off the connected electrical appliances if the inverter trips out due to overheating – Risk of injury!

### Caution

- Please observe the operating instructions for the connected appliances.

- If the power drawn by the connected appliances is above 150 W, the inverter in the socket will get warm. The inverter will trip out if the temperature exceeds a certain limit. The inverter can trip out on hot days even when an appliance with a suitable power rating is used. The inverter will switch on again automatically after it has cooled down. Appliances which are already connected and switched on will be activated again automatically ⇒ ⚠.
- Do not connect lamps which contain a neon tube. For technical reasons, this may damage the lamp.
- Do not connect 115 Volt appliances to the 230 Volt Euro socket. This may cause irreparable damage to the appliance. Check the type plate on the appliance if you are unsure of the voltage rating.
- With some power supplies (e.g. on laptop computers), the integrated surge suppressor prevents the equipment from being switched on because the starting current is too high. If this happens, please disconnect the power supply unit from the load and wait for about 10 seconds before re-connecting.

#### Note

- Unshielded equipment can cause interference on the radio, TV and vehicle's electrical system.
- The Euro socket has an integrated child safety device. There is no power at the socket until the Euro connector is fully inserted.
- Some appliances may not function normally due to the lower power rating (wattage).
- The socket can be operated with 115 Volt power supplies, as is the case in certain countries. In this case, a different type of inverter must be installed in the vehicle. Retrofit kits are available from your Audi dealer. Do not connect 115 Volt appliances to the 230 Volt Euro socket.
- Interference can occur on the radio's AM waveband if electrical appliances are used near the rear window aerial. ■

## Storage compartments

### Overview

*There are several storage compartments at various points in the vehicle.*

Glove box	⇒ page 90
Compartment for (sun)glasses in headliner	⇒ page 91
Storage compartments in the front seats	⇒ page 91
Coat hooks	⇒ page 91
First-aid kit	⇒ page 282
Side storage compartment in luggage compartment	⇒ page 80
Warning triangle	⇒ page 282

### Glove box

*The glove box is equipped with a lock\* and a light.*



Fig. 101 Glove box ▶

### Opening glove box

- Pull the catch on the lid in the direction indicated (arrow) ⇒ page 90, fig. 101 and open the lid.

### Closing glove box

- Close the lid and push it in until it engages.

The glove box lid has separate holders for a pen and a note pad.

On the right-hand side of the glove box there is a holder with a key shell. In order to start the engine with the spare key, it has to be clipped into this shell.

#### WARNING

To avoid the risk of injuries, always keep the glove box lid closed when driving. ■

### Compartment for (sun)glasses in headliner



Fig. 102 Compartment for (sun)glasses in headliner

- To open the cover, lightly press the panel ⇒ fig. 102 (arrow). The cover will then open by itself.
- To close the cover, push it upwards until it engages.

#### WARNING

Always keep the compartment cover closed while the vehicle is in motion to reduce the risk of injury during a sudden braking manoeuvre or in the event of an accident. ■

### Coat hooks

The coat hooks are located on the rear side of the B-pillars (in the rear passenger compartment).

#### WARNING

- Please make sure that any items of clothing hanging from the coat hooks do not obstruct your view to the rear.
- Only use the coat hooks for light items of clothing and make sure that there are no heavy or sharp objects in the pockets.
- Do not use clothes hangers to hang up the clothing, as this could interfere with the function of the head-protection airbags\*. ■

Applies to vehicles: with storage compartments in the front seats

### Storage compartments in front seats

There is a fold-out drawer in the front part of each front seat.

#### Opening

- Pull the handle to open the compartment.

#### Closing

- Close the lid and push it in until it engages. ►



## Seats and storage



### Note

The storage compartment will hold a maximum weight of 1 kg. ■

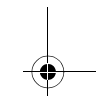
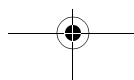
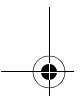
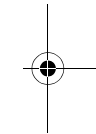
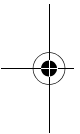

## Heating and cooling

### Deluxe automatic air conditioner

Applies to vehicles: with deluxe automatic air conditioner

#### Description

*The air conditioner can be used to set a comfortable interior temperature in the vehicle.*

The air conditioner provides heating and ventilation and also cools and dehumidifies the air inside the vehicle.

The air conditioner is fully automatic and will maintain the desired temperature at a constant level. To achieve this, the temperature of the air supplied to the interior, the blower speed (volume of air delivery) and the air distribution are regulated automatically. The system also allows for the effect of strong sunlight, so there is no need for manual adjustment. For these reasons it is advisable to use the **automatic mode** for the comfort of all the passengers in virtually all conditions throughout the year ⇒ *page 95*.

#### Please note:

The humidity of the air is automatically reduced when the system cools the interior of the vehicle. This helps to prevent condensation on the windows.

If the humidity and temperature outside the vehicle are high, **condensation** can drip off the evaporator in the air cooling system and form a pool underneath the vehicle. This is normal and does not indicate a leak.

If the outside temperature is low, the blower normally only switches to a higher speed once the coolant has warmed up sufficiently (this does not apply to the defrost setting).

In order to achieve maximum engine power, the air conditioner compressor is temporarily switched off when pulling away from a standstill with full throttle.

The compressor also switches off if the coolant temperature is excessively high, to ensure adequate engine cooling under extreme loads.

#### Pollution filter

The pollution filter (a particle filter) serves as a barrier against impurities in the outside air, including dust and pollen, and odours. The air is also filtered when the air recirculation mode is activated.

For the air conditioner to work with maximum efficiency, the pollution filter element must be replaced at the intervals specified in the Service Schedule.

If the vehicle is driven in areas with a high level of air pollution and the filter is no longer fully effective, it may be necessary to change the filter element more frequently.

#### Key-coded settings

The currently selected air conditioner settings are automatically stored and assigned to the remote control key.

#### Power management

To prevent the battery from becoming discharged and to maintain the necessary power level, the system will temporarily shut off the electrical components that are using a lot of power, or reduce the current they are consuming ⇒ *page 226*. Heating systems in particular use a large amount of electrical power. If you notice, for instance, that the rear window heater is not working, it may have been temporarily switched off by the **power management** function, or regulated to a lower heat output. These systems will be available again as soon as sufficient electrical power is available.

#### WARNING

**For safety reasons it is important that all the windows are kept free of ice, snow and condensation. These can cause poor visibility** ►

Controls

Safety

Driving tips

General maintenance

Self-help

Technical data

**⚠ WARNING (continued)**

and lead to an accident. Please familiarise yourself with the operating controls for the air conditioner, including the demist/defrost functions for the windows.

**⚠ Caution**

- If you suspect that the air conditioner is damaged, switch it off to prevent further damage and have the system checked by a qualified workshop.
- Repairs to the Audi air conditioner require specialist knowledge and special tools. For this reason, please contact a qualified workshop if the system is not working properly.

**i Note**

- Keep the air intake slots in front of the windscreen clear of snow, ice and leaves to ensure unimpaired heating and cooling, and to prevent the windows misting over.
- The air from the outlets flows through the passenger compartment and out through the slots at the rear of the vehicle. Do not cover these slots with clothing or other objects.
- The air conditioner operates most effectively with the windows and the tilting panorama roof\* closed. However, if the vehicle has heated up after standing in the sun for some time, the air inside can be cooled more quickly by opening the windows for a short time. ■

Applies to vehicles: with deluxe automatic air conditioner

**Controls**

*The controls for the air conditioner at a glance.*







**Fig. 103 Controls for deluxe automatic air conditioner**

The functions can be set by turning the rotary control and are switched on and off by briefly pressing the buttons. The LEDs in the buttons light up when the function is switched on.

Button(s)	Function	Page
OFF	Switching on and off	⇒ page 95
AUTO	Automatic mode	⇒ page 95
Rotary control <sup>a)</sup>	Temperature selection	⇒ page 96
	Blower	⇒ page 96
	Air recirculation mode	⇒ page 97



Button(s)	Function	Page
	Air distribution	⇒ page 97
	Defrosting windows	⇒ page 98
	Heated rear window	⇒ page 98
	Switching air cooling on/off	⇒ page 98
	Seat heating	⇒ page 114

a) The rotary control is also used to adjust the blower speed, air distribution and seat heating.

### Note

The grille on the control console ⇒ page 94, fig. 103 must be kept free. Please ensure that it is not covered by stickers or similar. Measuring sensors are located behind it. ■

Applies to vehicles: with deluxe automatic air conditioner

## Switching on and off

### Switching on air conditioner

- Press the **OFF** button briefly, or
- Press the **AUTO** button.

### Switching off air conditioner

- Press the **OFF** button to switch off the air conditioner and cut off the supply of fresh air from outside the vehicle.

The air conditioner will switch on again if one of the control buttons is pressed. ■

Applies to vehicles: with deluxe automatic air conditioner

## Automatic mode **AUTO**

*The standard operating mode for all seasons.*

### Switching on automatic mode

- Select a temperature between +16 °C (60 °F) and +28 °C (84 °F).
- Press the **AUTO** button.

The automatic mode maintains a constant temperature inside the vehicle and dehumidifies the air. Air temperature, air delivery and air distribution are regulated automatically to reach the desired interior temperature as quickly as possible, and then to maintain this temperature. The system automatically compensates for any variations in the outside temperature and for the effect of direct sunlight.

The automatic temperature regulation only operates at temperature settings between +16 °C and +28 °C. If a temperature below +16 °C is selected, **LO** appears on the display. If a temperature above +28 °C is selected, the display will show **HI**. In the two extreme settings the air conditioner operates continuously with maximum cooling or heating output, and the temperature is not regulated automatically. ■

Applies to vehicles: with deluxe automatic air conditioner

### Temperature selection



Fig. 104 Rotary control for temperature selection



Fig. 105 Display: Temperature setting

- Turn the rotary control anti-clockwise to reduce the temperature or clockwise to increase the temperature ⇒ fig. 104.

The temperature setting will be shown on the screen ⇒ fig. 105 for a few seconds if the sound system or MMI\* is switched on. ■

Applies to vehicles: with deluxe automatic air conditioner

### Blower

*The automatically selected blower speed can be reduced or increased manually if required.*



Fig. 106 Blower button and rotary control



Fig. 107 Display: Blower setting

- Press the button for the **blower** (🌀).
- Turn the rotary control to set the blower to the desired speed (and regulate the volume of air delivery).

We recommend keeping the blower running at a low setting when driving slowly.

To prevent fumes or unpleasant smells from entering the vehicle, switch to the **air recirculation** mode by pressing the (🌀) button. ►

The blower speed will be shown on the screen => *page 96*, fig. 107 for a few seconds if the sound system or MMI\* is switched on.

### Note

- The blower speed may change automatically. This ensures that the selected temperature is reached as quickly as possible.
- The blower speed cannot be regulated separately for the driver and front passenger sides of the vehicle. ■

Applies to vehicles: with deluxe automatic air conditioner

### Air recirculation mode

*The air recirculation setting prevents fumes etc. from entering the interior.*

#### Switching on the air recirculation mode

- Press the  button => .

#### Switching off the air recirculation mode

- Press the  button again, or
- Press the **AUTO** button, or
- Press the  button.

In this setting, the air is drawn from the interior of the vehicle, filtered and continuously recirculated. We recommend using the air recirculation mode in the following circumstances:

When driving through a tunnel or in queues of traffic, to prevent fumes entering the interior of the vehicle.

### WARNING

**For reasons of safety you should not leave the air recirculation switched on for too long. This mode prevents fresh air from**

### WARNING (continued)

**entering the vehicle, so the windows can mist over if the air cooling is switched off. Bad visibility can cause an accident. ■**

Applies to vehicles: with deluxe automatic air conditioner

### Air distribution

*The automatically programmed air distribution can be altered manually if required.*





Fig. 108 Air distribution button and rotary control



Fig. 109 Display: Air distribution

- Press the button for **Distribution** .
- Turn the rotary control to the desired setting. ►

You can use the air distribution setting to select the air outlets you wish to activate. In setting  all the air is directed to the windows, in setting  the air is directed to the driver (or passenger), and in setting  to the footwells. In addition to this there are several other possible combinations, allowing you to adjust the air distribution to suit individual requirements.



Switch to **AUTO** for automatic control of the air distribution.

The air distribution setting will be shown on the screen => *page 97*, fig. 109 for a few seconds if the sound system or MMI\* is switched on. ■

Applies to vehicles: with deluxe automatic air conditioner

### Defrosting

*The windscreen and side windows are defrosted or demisted as quickly as possible.*

- To switch on, press the  button.
- To switch off, press the  button again, or press the **AUTO** button.

The temperature is regulated automatically. The air output is increased to maximum and most of the air comes out of the outlets below the windscreen.

The air recirculation mode is switched off when the  button is pressed. ■

Applies to vehicles: with deluxe automatic air conditioner

### Heated rear window

*The rear window heating helps to demist the rear window.*

- Press the  button to switch the rear window heating on and off.

The rear window heating only works when the engine is running. An indicator lamp in the button lights up when the rear window heater is switched on.

Depending on the outside temperature, the rear window heating switches off automatically after about 10 to 20 minutes.

The rear window heating can be switched on permanently by pressing the  button for longer than two seconds. It will then remain on until the ignition is switched off. When the rear window heating is switched on, this setting will remain activated for 15 minutes after switching off the ignition.

If the engine is started again during this period of 15 minutes, the rear window heating will be switched on for about 10 to 20 minutes, depending on the exterior temperature. This means you do not have to manually switch on the rear window heating again if the vehicle has only been parked for a short time.

### For the sake of the environment

Switch off the heated rear window manually as soon as the rear window is clear. By saving electrical power you can also save fuel. ■

Applies to vehicles: with deluxe automatic air conditioner

### AC mode **AC**

#### Deactivating the AC mode

- Press the **AC** button.

#### Activating the AC mode

- Press the **AC** button again.

In the AC mode, the air cooling system is switched on and the heating and ventilation are regulated automatically. ►

**Note**

If the LED in the AC button should continue to light up when the AC mode has been switched off (i.e. the air conditioner has been switched off) this is due to a defect in one of the air conditioner components. If a malfunction should occur, please contact a qualified workshop. ■

Applies to vehicles: with deluxe automatic air conditioner

**Air outlets**

*The air distribution setting directs the air to the outlets you select.*

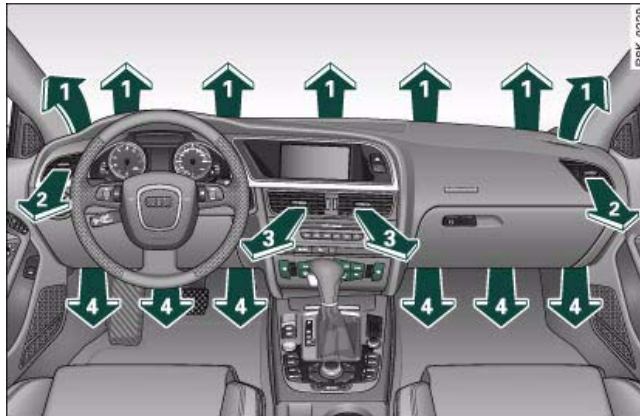

Fig. 110 Dashboard: Location of air outlets

**Air outlets ② and ③**

- The outlets can be opened and closed by turning the thumbwheels next to them.

- The direction of air delivery from these outlets can be adjusted horizontally and vertically using the adjuster in the centre of each outlet grille.

The flow of air from the outlets is controlled either automatically or manually, depending on the operating mode selected. All the outlets can provide air which is either heated, unheated, or cooled.

**Note**

When the air conditioner is operating in the cooling mode, the air is directed mainly to outlets ② and ③. To ensure an adequate cooling effect, you should not close these outlets completely. ■

Applies to vehicles: with deluxe automatic air conditioner

**Air outlets for rear passengers**

*The air outlets for the rear cabin are located in the centre console.*

- The outlets can be opened and closed by turning the thumbwheels.
- The direction of air delivery from these outlets can be adjusted horizontally and vertically using the adjuster in the centre of each outlet grille.

The flow of air from the outlets is controlled either automatically or manually, depending on the operating mode selected. All the outlets can provide air which is either heated, unheated, or cooled.

The heater outlets for the rear footwells are located under the front seats.

**Note**

When the air conditioner is operating in the cooling mode the air is directed mainly to the outlets in the centre console. To ensure an ►

adequate cooling effect, you should not close these outlets completely. ■

Applies to vehicles: with deluxe automatic air conditioner

### Economical operation of the air conditioner

*Economical operation of the air conditioner will help to save fuel.*

When the air conditioner is operating in the cooling mode it reduces engine power and increases fuel consumption. To ensure that the cooling mode is activated only when really necessary, please note the following points:

- Switch off the cooling mode by pressing the AC button (LED off) if you wish to save fuel.
- You should also switch off the cooling mode by pressing the AC button (LED off) if you open the windows or the tilting panorama roof\* while driving.
- If the vehicle has heated up after standing in the sun, open the windows and doors for a short time to cool the vehicle.

### For the sake of the environment

By saving fuel you also reduce the amount of pollutants emitted from your vehicle. ■

## Deluxe automatic air conditioner - basic settings

Applies to vehicles: with deluxe automatic air conditioner

### General notes

*The basic settings for the air conditioner can be adjusted via the sound system or MMI\*.*



Fig. 111 Display: Setup AC

- Select: Function selector button **CAR** > control button AC.

The following functions are available:

- Auxiliary heating\* ⇒ page 110
- Auxiliary ventilation\* ⇒ page 110
- Running time\* ⇒ page 112
- Timer status\* ⇒ page 111
- Timer 1\* ⇒ page 111
- Timer 2\* ⇒ page 111
- Timer 3\* ⇒ page 111
- Supplementary heater\* ⇒ page 101 ■

Applies to vehicles: with diesel engine

### Supplementary heater

- Set the **Supplementary heater** to **auto** or **off**.

Models with a diesel engine are equipped with a supplementary heater to help warm up the interior more quickly. At outside temperatures below about +5 °C the supplementary heater is switched on (and off) automatically when the engine is running, depending on the coolant temperature, the temperature in the vehicle interior and the temperature the heater is set to. ■

## Deluxe automatic air conditioner plus

Applies to vehicles: with deluxe automatic air conditioner plus

### Description

*The air conditioner is designed to keep the passenger compartment at the temperature you find most comfortable at all times of the year.*

The air conditioner provides heating and ventilation and also cools and dehumidifies the air inside the vehicle.

The air conditioner is fully automatic, and will maintain the desired temperature at a constant level. To achieve this, the temperature of the air supplied to the interior, the blower speed (volume of air delivery) and the air distribution are regulated automatically. The system also allows for the effect of strong sunlight, so there is no need for manual adjustment. For these reasons it is advisable to use the **automatic mode** for the comfort of all the passengers in virtually all conditions throughout the year ⇒ *page 103*.

#### Please note:

The humidity of the air is automatically reduced when the system cools the interior of the vehicle. This helps to prevent condensation on the windows.

If the humidity and temperature outside the vehicle are high, **condensation** can drip off the evaporator in the air cooling system and form a pool underneath the vehicle. This is normal and does not indicate a leak.

If the outside temperature is low, the blower normally only switches to a higher speed once the coolant has warmed up sufficiently (this does not apply to the defrost setting).

In order to achieve maximum engine power, the air conditioner compressor is temporarily switched off when pulling away from a standstill with full throttle.

The compressor also switches off if the coolant temperature is excessively high, to ensure adequate engine cooling under extreme loads.

#### Pollution filter

The pollution filter (a combined particle filter and activated charcoal filter) serves as a barrier against impurities in the outside air, including dust and pollen, and against unpleasant smells. The air is also filtered when the air recirculation mode is activated.

For the air conditioner to work with maximum efficiency, the pollution filter element must be replaced at the intervals specified in the Service Schedule.

If the vehicle is driven in areas with a high level of air pollution and the filter is no longer fully effective, it may be necessary to change the filter element more frequently.

#### Key-coded settings

The currently selected air conditioner settings are automatically stored and assigned to the remote control key.

#### Power management

To prevent the battery from becoming discharged and to maintain the necessary power level, the system will temporarily shut off the electrical components that are using a lot of power, or reduce the current they are consuming ⇒ *page 226*. Heating systems in particular use a large amount of electrical power. If you notice, for

instance, that the rear window heater is not working, it may have been temporarily switched off by the **power management** function, or regulated to a lower heat output. These systems will be available again as soon as sufficient electrical power is available.

### **WARNING**

**For safety reasons it is important that all the windows are kept free of ice, snow and condensation. These can cause poor visibility and lead to an accident. Please familiarise yourself with the operating controls for the air conditioner, including the demist/defrost functions for the windows.**

### **Caution**

- If you suspect that the air conditioner is damaged, switch it off to prevent further damage and have the system checked by a qualified workshop.
- Repairs to the air conditioning system require specialist knowledge and special tools. For this reason, please contact a qualified workshop if the system is not working properly.

### **Note**

- Keep the air intake slots in front of the windscreen clear of snow, ice and leaves to ensure unimpaired heating and cooling, and to prevent the windows misting over.
- The air from the outlets flows through the passenger compartment and out through the slots at the rear of the vehicle. Do not cover these slots with clothing or other objects.
- The air conditioner operates most effectively with the windows and the tilting panorama roof\* closed. However, if the vehicle has heated up after standing in the sun for some time, the air inside can be cooled more quickly by opening the windows for a short time. ■

Applies to vehicles: with deluxe automatic air conditioner plus

## Controls

*The controls for the air conditioner at a glance.*











**Fig. 112 Air conditioner controls**

The left-hand display shows the temperature selected for the left-hand side, the right-hand display the temperature for the right-hand side.

The functions can be switched on and off by turning the controls or briefly pressing the buttons. The LEDs in the buttons light up when the function is switched on. ▶



Button(s)	Function	Page
	Switching on and off	⇒ page 103
	Automatic mode - drivers side/ front passengers side	⇒ page 103
Temperature control 1 <sup>a)</sup> Temperature control 2 <sup>a)</sup>	Temperature selection - drivers side Temperature selection - front passengers side	⇒ page 104
	Blower - driver's side/ front passenger's side	⇒ page 104
 <sup>b)</sup>	Air recirculation mode	⇒ page 105
	Air distribution - drivers side/ front passengers side	⇒ page 106
	Defrosting windows	⇒ page 106
	Heated rear window	⇒ page 106
	Switching air cooling on/off	⇒ page 107
	Seat heating / seat ventila- tion	⇒ page 114

<sup>a)</sup> The rotary control is also used to adjust the blower speed, air distribution and seat heating.

<sup>b)</sup> The symbol differs slightly on some models.

### Note

- The grille on the control console ⇒ page 102, fig. 112 must be kept free. Please ensure that it is not covered by stickers or similar. Measuring sensors are located behind it. ■

Applies to vehicles: with deluxe automatic air conditioner plus

### Switching on and off

#### Switching on air conditioner

- Press the  button briefly, or
- Press the  button.

#### Switching off air conditioner

- Press the  button *for at least 2 seconds* to switch off the air conditioner and cut off the supply of fresh air from outside the vehicle. The display will show "OFF".

The air conditioner will switch on again if you operate the **temperature control**.

### Note

You can press the  button when the ignition is switched off to activate the "residual heat" function. The system will then heat the interior using the remaining heat in the engine coolant. ■

Applies to vehicles: with deluxe automatic air conditioner plus

### Automatic mode

*The standard operating mode for all seasons.*

#### Switching on automatic mode

- Select a temperature between +16 °C (60 °F) and +28 °C (84 °F).
- Press the  button.

The automatic mode maintains a constant temperature inside the vehicle and dehumidifies the air. Air temperature, air delivery and air distribution are regulated automatically to reach the desired 

interior temperature as quickly as possible, and then to maintain this temperature. The system automatically compensates for any variations in the outside temperature and for the effect of direct sunlight.

The automatic temperature regulation only operates at temperature settings between +16 °C and +28 °C. If a temperature below +16 °C is selected, **LO** appears on the display. If a temperature above +28 °C is selected, the display will show **HI**. In the two extreme settings the air conditioner operates continuously with maximum cooling or heating output, and the temperature is not regulated automatically. ■

Applies to vehicles: with deluxe automatic air conditioner plus

### Temperature selection

*Separate temperatures can be selected for the driver's and front passenger's sides.*



Fig. 113 Rotary control for temperature selection



Fig. 114 Display: Temperature setting

- Turn the rotary control anti-clockwise to reduce the temperature or clockwise to increase the temperature ⇒ fig. 113.

The temperature setting will be shown on the display of the air conditioner console. The temperature setting will be shown on the screen ⇒ fig. 114 for a few seconds if the sound system or MMI\* is switched on. ■

Applies to vehicles: with deluxe automatic air conditioner plus

### Blower

*The automatically selected blower speed can be reduced or increased manually if required.*



Fig. 115 Blower button and rotary control



Fig. 116 Display:  
Blower setting

- Press the button for the **blower** .
- Turn the rotary control to set the blower to the desired speed (and regulate the volume of air delivery).

The air conditioning system automatically regulates the blower speed according to the interior temperature. However, you can also adjust the blower speed manually.

The blower speed will be shown on the screen ⇒ fig. 116 for a few seconds if the sound system or MMI\* is switched on.

#### Note

- The blower speed may change automatically. This ensures that the selected temperature is reached as quickly as possible.
- The blower speed cannot be regulated separately for the driver and front passenger sides of the vehicle. ■

Applies to vehicles: with deluxe automatic air conditioner plus

#### **Air recirculation mode**

*The air recirculation setting prevents fumes etc. from entering the interior.*

#### **Switching on the air recirculation mode**

- Press the  button ⇒ .

#### **Switching off the air recirculation mode**

- Press the  button again, or
- Press the **AUTO** button, or
- Press the  button.

In this setting, the air is drawn from the interior of the vehicle, filtered and continuously recirculated. We recommend using the air recirculation mode in the following circumstances:

When driving through a tunnel or in queues of traffic, to prevent fumes entering the interior of the vehicle.

#### **WARNING**

**For reasons of safety you should not leave the air recirculation switched on for too long. This mode prevents fresh air from entering the vehicle, so the windows can mist over if the air cooling is switched off. Bad visibility can cause an accident. ■**

Applies to vehicles: with deluxe automatic air conditioner plus

### Air distribution

*The automatically programmed air distribution can be altered manually if required.*





Fig. 117 Air distribution button and rotary control



Fig. 118 Display: Air distribution

- Press the button for **Distribution** .
- Turn the rotary control to the desired setting.

You can use the air distribution setting to select the air outlets you wish to activate. In setting  all the air is directed to the windows, in setting  the air is directed to the driver (or passenger), and in setting  to the footwells. In addition to this there are several other possible combinations, allowing you to adjust the air distribution to suit individual requirements.



Switch to **AUTO** for automatic control of the air distribution.

The air distribution setting will be shown on the MMI display  $\Rightarrow$  fig. 118 for a few seconds if the MMI is switched on. ■

Applies to vehicles: with deluxe automatic air conditioner plus

### Defrosting

*The windscreen and side windows are defrosted or demisted as quickly as possible.*

- To switch on, press the  button.
- To switch off, press the  button again, or press the **AUTO** button.

The temperature is regulated automatically. The air output is increased to maximum and most of the air comes out of the outlets below the windscreen.

The air recirculation mode is switched off when the  button is pressed. ■

Applies to vehicles: with deluxe automatic air conditioner plus

### Heated rear window

*The rear window heating helps to demist the rear window.*

- Press the  button to switch the rear window heating on and off.

The rear window heating only works when the engine is running. An indicator lamp in the button lights up when the rear window heater is switched on.

Depending on the outside temperature, the rear window heating switches off automatically after about 10 to 20 minutes.

The rear window heating can be switched on permanently by pressing the  button for longer than two seconds. It will then  $\blacktriangleright$

remain on until the ignition is switched off. When the rear window heating is switched on, this setting will remain activated for 15 minutes after switching off the ignition.

If the engine is started again during this period of 15 minutes, the rear window heating will be switched on for about 10 to 20 minutes, depending on the exterior temperature. This means you do not have to manually switch on the rear window heating again if the vehicle has only been parked for a short time.

#### For the sake of the environment

Switch off the heated rear window manually as soon as the rear window is clear. By saving electrical power you can also save fuel. ■

Applies to vehicles: with deluxe automatic air conditioner plus

#### AC mode

##### Deactivating the AC mode

- Press the  button.

##### Activating the AC mode

- Press the  button again.

In the AC mode, the air cooling system is switched on and the heating and ventilation are regulated automatically.

#### Note

If the LED in the AC button should continue to light up when the AC mode has been switched off (i.e. the air conditioner has been switched off) this is due to a defect in one of the air conditioner components. If a malfunction should occur, please contact a qualified workshop. ■

Applies to vehicles: with deluxe automatic air conditioner plus

#### Air outlets

*The air distribution setting directs the air to the outlets you select.*

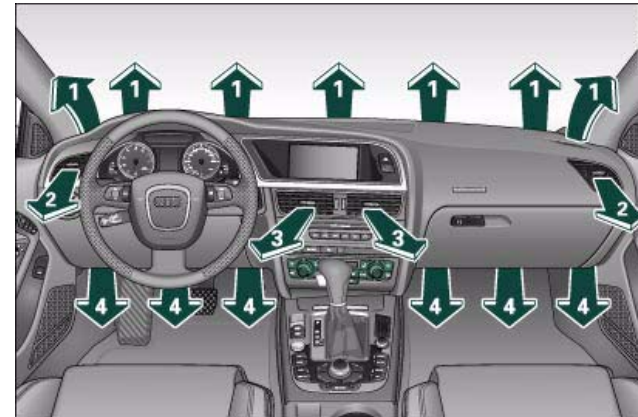

Fig. 119 Dashboard: Location of air outlets

#### Air outlets ② and ③

- The outlets can be opened and closed by turning the thumbwheels next to them.
- The direction of air delivery from these outlets can be adjusted horizontally and vertically using the adjuster in the centre of each outlet grille.

The flow of air from the outlets is controlled either automatically or manually, depending on the operating mode selected. Outlets ① to ④ can provide air which is either heated, unheated, or cooled. ►



**i Note**

When the air conditioner is operating in the cooling mode, the air is directed mainly to outlets ② and ③. To ensure an adequate cooling effect, you should not close these outlets completely. ■

Applies to vehicles: with deluxe automatic air conditioner plus

**Air outlets for rear passengers**

*The air outlets for the rear cabin are located in the centre console.*

- The outlets can be opened and closed by turning the thumbwheels.
- The direction of air delivery from these outlets can be adjusted horizontally and vertically using the adjuster in the centre of each outlet grille.

The flow of air from the outlets is controlled either automatically or manually, depending on the operating mode selected. All the outlets can provide air which is either heated, unheated, or cooled.

The heater outlets for the rear footwells are located under the front seats.

**i Note**

When the air conditioner is operating in the cooling mode the air is directed mainly to the outlets in the centre console. To ensure an adequate cooling effect, you should not close these outlets completely. ■

Applies to vehicles: with deluxe automatic air conditioner plus

**Economical operation of the air conditioner**

*Economical operation of the air conditioner will help to save fuel.*

When the air conditioner is operating in the cooling mode it reduces engine power and increases fuel consumption. To ensure that the cooling mode is activated only when really necessary, please note the following points:

- Switch off the cooling mode by pressing the AC button (LED off) if you wish to save fuel.
- You should also switch off the cooling mode by pressing the AC button (LED off) if you open the windows or the tilting panorama roof\* while driving.
- If the vehicle has heated up after standing in the sun, open the windows and doors for a short time to cool the vehicle.

**✿ For the sake of the environment**

By saving fuel you also reduce the amount of pollutants emitted from your vehicle. ■

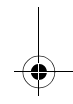
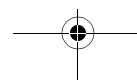
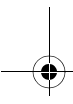
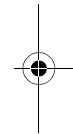
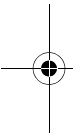

## Deluxe automatic air conditioner plus - basic settings

Applies to vehicles: with deluxe automatic air conditioner plus

### General notes

*The basic settings for the air conditioner can be adjusted via the sound system or MMI\*.*

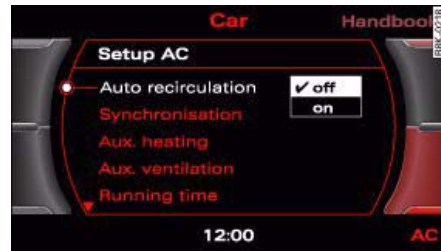

Fig. 120 Display:  
Setup AC

- Select: Function selector button **[CAR]** > control button AC.

The following functions are available:

- Automatic air recirculation ⇒ page 109
- Synchronisation ⇒ page 109
- Auxiliary heating\* ⇒ page 110
- Auxiliary ventilation\* ⇒ page 110
- Running time\* ⇒ page 112
- Timer status\* ⇒ page 111
- Timer 1\* ⇒ page 111
- Timer 2\* ⇒ page 111
- Timer 3\* ⇒ page 111
- Supplementary heater\* ⇒ page 110 ■

Applies to vehicles: with deluxe automatic air conditioner plus

### Automatic recirculation

*If the outside air is polluted, an air purity sensor in the vehicle will automatically switch on the air recirculation.*

To prevent fumes, etc. in the outside air from entering the interior, we recommend that the automatic air recirculation should be switched on at all times.

If the **air purity sensor** in the air conditioner system detects a certain concentration of fumes in the outside air, the control unit will either pass the incoming air through the pollution filter or automatically switch on the air recirculation. If there is a high concentration of pollution in the outside air, the air conditioner automatically switches to air recirculation and cuts off the supply of air from the outside. As soon as the level of pollution decreases, air is fed into the vehicle from the outside again.

If the windows mist up when the automatic air recirculation is on, press the  button immediately.

The automatic air recirculation can switch itself off in certain conditions. If the outside temperature is less than about +10 °C, the automatic air recirculation will only operate for 30 seconds. If the air conditioner is switched to the ECON mode, or if the outside temperature is less than about -1 °C, the automatic air recirculation will only operate for 15 seconds. ■

Applies to vehicles: with deluxe automatic air conditioner plus

### Synchronisation

*The air conditioner settings can be synchronised for all passengers.*

When the synchronisation function is switched **on**, all subsequent air conditioner settings made on the driver's side (except for the seat heating\*) are also applied to the front passenger's side. ►

The synchronisation is cancelled as soon as any adjustments are made on the front passenger's side. ■

Applies to vehicles: with diesel engine

### Supplementary heater

- Set the **Supplementary heater** to **auto** or **off**.

Models with a diesel engine are equipped with a supplementary heater to help warm up the interior more quickly. At outside temperatures below about +5 °C the supplementary heater is switched on (and off) automatically when the engine is running, depending on the coolant temperature, the temperature in the vehicle interior and the temperature the heater is set to. ■

## Auxiliary heating and auxiliary ventilation

Applies to vehicles: with auxiliary heating - under development at the time of printing

### Description

*The auxiliary heating and ventilation systems heat and cool the interior independently of the engine.*

The **auxiliary heating**  works in conjunction with the air conditioner system, but does not rely on heat from the engine. Instead of this, the system burns fuel. The system's main function is to warm up the interior of the vehicle and to defrost the windows in cold weather.

The auxiliary heating system can be used both when the vehicle is stationary and when driving (to provide extra heat while the engine is warming up).

The **auxiliary ventilation**  also operates independently of the engine. This feature can be used to cool the interior with the blower when the vehicle is left parked in the sun.

The system will automatically activate either the auxiliary heating or the auxiliary ventilation mode, depending on the actual temperature measured inside the car and the temperature you have set with the air conditioner controls. It is possible to alter the temperature setting while the auxiliary heating/ventilation is running.

### Switching on and off

There are two different ways of switching on the auxiliary heating/ventilation system.

- **Immediate start:** You can switch the auxiliary heating/ventilation on and off at any time via the sound system or MMI ⇒ *page 111*. You can also switch the system on and off using the remote control ⇒ *page 113*.
- **Switching on via timer:** You can programme various start times using the timers ⇒ *page 111*. However you must first activate the timer before the auxiliary heating/ventilation system will switch on automatically.



The auxiliary heating/ventilation will switch itself off at the end of the programmed running time. The running time can be set to 15, 30, 45 or 60 minutes ⇒ *page 112*.

### WARNING

- **The auxiliary heating must not be allowed to run when the vehicle is in a confined space because it can give off toxic fumes.**
- **To avoid any possible fire risk, never have the auxiliary heating switched on when refuelling the vehicle.**
- **Because of the high temperatures which occur when the auxiliary heating is running, make sure when parking the car that the exhaust outlet under the car is not obstructed in any way and that the exhaust gases do not come into contact with flammable materials (fire risk).**



**Note**

- It is advisable to open the air outlets when using the auxiliary heating/ventilation.
- The auxiliary heating/ventilation will not switch on if the fuel in the tank has reached the reserve zone.
- The auxiliary heating/ventilation will not switch on if the battery charge level is low.
- The symbols  (auxiliary ventilation) or  (auxiliary heating) flash in the instrument cluster next to the clock display when the auxiliary heating/ventilation is switched on. Both symbols light continuously when the timer is activated.
- At low outside temperatures some visible water vapour may form in the engine compartment. This is a normal phenomenon, and no reason for concern. ■

Applies to vehicles: with auxiliary heating - under development at the time of printing

**Switching on/off immediately**

You can switch the auxiliary heating/ventilation on and off immediately via the sound system or MMI\*.





Fig. 121 Display: Setup AC

- Select: Function selector button **CAR** > control button AC > **Aux. heating** or **Aux. ventilation**.

When the auxiliary heating/ventilation is running, you can press the **OFF** button on the air conditioner console to switch off the blower only. Pressing the **OFF** button a second time will switch on the blower again.

**Note**

The symbols  (auxiliary ventilation) or  (auxiliary heating) flash in the instrument cluster next to the clock display when the auxiliary heating/ventilation is switched on. ■

Applies to vehicles: with auxiliary heating - under development at the time of printing

**Setting and activating the timers**

You can make the desired settings for the auxiliary heating/ventilation on the sound system or MMI\*.



Fig. 122 Display: Timer



Fig. 123 Display: Timer status

### Setting the timers

- Select: Function selector button **CAR** > control button AC > e.g. **Timer 1** ⇒ page 111, fig. 122.

### Activating a timer

- Select: Function selector button **CAR** > control button AC > **Timer status** ⇒ fig. 123.

Three timers are available for the auxiliary heating/ventilation. You can set a starting time and running time for each of the timers.

When the time set on one of the timers elapses, the date automatically changes to the next day and the **Timer status** is reset to off. You have to **activate one of the timers** (e.g. T1 on) before it will switch on the auxiliary heating/ventilation at the time you have set. This prevents the auxiliary heating/ventilation from switching on when you are not using your vehicle.

### Note

Before activating the timer, make sure that the correct time and date settings have been entered. If the time and/or date are not correct, the auxiliary heating will come on late or not at all. Please refer to the MMI Operating Instructions for information on how to set the date and time. ■

Applies to vehicles: with auxiliary heating - under development at the time of printing

### Setting the running time

You can set the running time on the sound system or MMI\*.

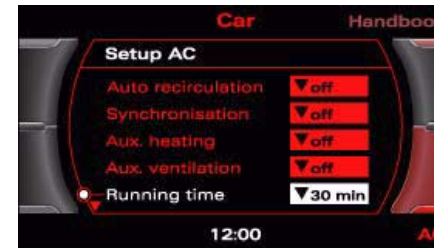

Fig. 124 Display: Running time

- Select: Function selector button **CAR** > control button AC > **Running time**.

The running time for the auxiliary heating/ventilation can be set to a time between 15 and 60 minutes. The auxiliary heating/ventilation will switch itself off at the end of the programmed running time. ■

Applies to vehicles: with auxiliary heating - under development at the time of printing

### Remote control

*The auxiliary heating and auxiliary ventilation can also be switched on or off with the remote control.*



Fig. 125 Remote control for auxiliary heating



Fig. 126 Remote control: Changing battery

### Switching on

- Press the button ① for about 2 seconds to activate the auxiliary heating/ventilation ⇒ fig. 125.

### Switching off

- Press the button ② for about 2 seconds to switch off the auxiliary heating/ventilation.

### Changing the battery

- Push back and remove the battery cover on the remote control ⇒ fig. 126.
- Change the battery. The diagram in the battery compartment shows how the battery should be fitted. The new battery must be of the same type as the original one.
- Re-fit the battery cover.

When it is switched on, the auxiliary heating or auxiliary ventilation starts immediately and remains on for the period set in the menu. The maximum running time is 60 minutes.

If you want to switch the system on again after the end of the programmed running time, press the button ①.

### Transmitter indicator lamp

The transmitter indicator lamp ③ will flash accordingly to show whether the command you sent via the remote control was successful.

When you switch the system on by pressing the button ① the indicator lamp will flash green for about 30 seconds to confirm that the heating/ventilation has been switched on. When you switch the system off by pressing the button ② the indicator lamp will flash red to confirm that the heating/ventilation has been switched off.

If the remote control is outside the transmitting range the indicator lamp will flash red slowly. If there is a fault in the system (e.g. fuel level is down to reserve), the indicator lamp will flash red rapidly. In both cases the command will not be executed.

When the battery of the remote control is almost completely flat, the transmitter indicator lamp will not light up and no commands will be executed. ▶

### Transmitting range

The range of the remote control transmitter is about 600 metres. However, this can be greatly reduced by obstacles (buildings, etc.) between the remote control transmitter and the vehicle. Hold the aerial (4) upright when using the remote control.

You should not normally use the remote control at a distance of less than 3 metres from the vehicle. If you are closer than this, or if you use the remote control inside the vehicle, this can cause signal overload.



### For the sake of the environment

Please dispose of old batteries in the proper manner so that they do not harm the environment. ■

## Seat heating

Applies to vehicles: with front seat heating/ventilation

### Seat heating / ventilation

*The seat cushions and backrests of the front seats can be heated and ventilated\* electrically.*



Fig. 127 Display: Seat heating



Fig. 128 Display: Seat heating/ventilation

### Seat heating

- Press the control button for Seat heat. (img alt="Seat heat button icon") => fig. 127.
- Turn the rotary control to the desired setting.

### Seat heating/ventilation\*

- Press the control button for **Seat AC** (img alt="Seat AC button icon") => fig. 128.
- To adjust the seat ventilation, turn the rotary control anti-clockwise to the desired setting.
- To adjust the seat heating, turn the rotary control clockwise to the desired setting.

In setting 0, the seat ventilation and seat heating are switched off.



### Caution

To avoid damaging the heating elements of the seat heating, please do not kneel on the seat or apply sharp pressure at a single point. ■

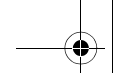

Applies to vehicles: with seat heating for rear seats

### **Seat heating for rear seats**

*The seat cushions and backrests of the two outer rear seats can be heated electrically.*

- Turn the left thumbwheel (on the centre console) to switch on and regulate the heating for the left rear seat.
- Turn the right thumbwheel (on the centre console) to switch on and regulate the heating for the right rear seat.

The heating is switched off when the thumbwheel is set to 0.  
Possible settings range from 1 to 6.

The heating for the rear seats only operates when a sensor registers the weight of the occupant in the seat. If nobody is travelling on the rear seats, please switch off the rear seat heating to avoid activating it unintentionally.

#### **Caution**

To avoid damaging the heating elements of the seat heating, please do not kneel on the seat or apply sharp pressure at a single point. ■

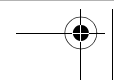
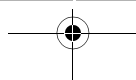
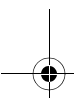
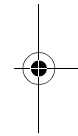
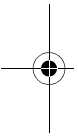

## Driving

### Steering

Applies to vehicles: with manually adjustable steering column

#### Adjusting the steering wheel position

The height and reach of the steering wheel can be adjusted as required to suit the driver.

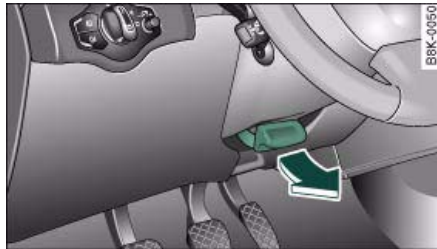

Fig. 129 Lever beneath steering column

- Pull the lever ⇒ fig. 129 -arrow- ⇒ ⚠ up.
- Move the steering wheel to the desired position.
- Then push the lever towards the steering column until the catch engages.

#### ⚠ WARNING

- Never adjust the position of the steering wheel when the vehicle is moving - this could cause an accident.
- For safety reasons, the lever must be pushed securely against the steering column to prevent the steering wheel from accidentally changing position while driving (accident risk). ■

### Ignition lock

#### Starting the engine with the key

You can use the ignition key to switch on the ignition and start the engine.



Fig. 130 Ignition key

- Insert the key into the ignition lock.
- *Manual gearbox:* Press the clutch pedal all the way down and move the gear lever into neutral.
- *Automatic gearbox:* Press the brake pedal and move the selector lever to position P or N.
- **Press in** the key ⇒ fig. 130 to start the engine.
- Diesel engines can take a few seconds longer than usual to start on cold days. Please keep your foot on the clutch or brake pedal until the engine starts. The glow plug indicator lamp ⚡ lights up in the instrument cluster while the glow plugs are preheating. ▶

If you press in the key **without** pressing the clutch or brake pedal, the ignition will be switched on or off. The steering lock is released when the ignition is switched on. Diesel engines continue to be automatically preheated.

The key can be removed only when the ignition is off. The key has to be pressed in briefly to switch off the ignition. On vehicles with an automatic gearbox, the selector lever has to be in position P.

Electrical components with a high power consumption are switched off temporarily while you start the engine.

When starting from cold the engine may be a little noisy for the first few seconds until oil pressure has built up in the hydraulic tappets. This is quite normal and no cause for concern.

If the engine fails to start immediately, the starter will be switched off automatically after a few seconds. Try to start the engine again.

#### Driver message in the instrument cluster display

##### Press brake pedal to start engine

This message appears on vehicles with an automatic gearbox if you try to start the engine without first pressing the brake pedal.

##### Press clutch pedal to start engine

This message appears on vehicles with a manual gearbox if you try to start the engine without first pressing the clutch pedal.

##### Engage N or P to start engine

This message will appear if you try to start the engine when the selector lever of the automatic gearbox is not in P or N.

**Shift to P, otherwise vehicle can roll away. Doors do not lock if lever is not in P. or Please move selector lever to position P. Vehicle cannot be locked.**

For safety reasons, this message will appear and a warning buzzer will sound if the selector lever of the automatic gearbox is not in position P after you switch off the ignition. Put the selector lever in position P; otherwise the vehicle can roll away. If the lever is not in

position P you will not be able to lock the vehicle using the exterior locking switch on the door handle or the remote control key.

#### Steering lock

The steering is locked when the key is not in the ignition. The steering lock acts as a theft deterrent.

#### WARNING

- **Always take the key with you when you leave the vehicle. Otherwise the engine can be started or power-operated equipment such as the electric windows can be used. This could result in serious injury.**
- **Never leave children or disabled people alone in the car. The doors could be locked with the remote control key and the occupants could become trapped in the vehicle. The vehicle occupants could be exposed to extremely high or low temperatures, depending on the time of year.**
- **Never remove the key from the ignition while the vehicle is moving. The steering lock could engage suddenly, and you would not be able to steer the car.**

#### Caution

- If a malfunction occurs in the electronic ignition lock, a flashing symbol and the message **Ignition lock defective** will appear in the instrument cluster display.
- Avoid high engine speeds, full throttle and extreme load conditions until the engine has reached its normal operating temperature, otherwise this can damage the engine.

#### For the sake of the environment

Do not warm up the engine by running it with the car stationary. You should drive off immediately whenever possible. This will help avoid unnecessary exhaust emissions. ▶

**i Note**

- If the key should become stuck in the ignition lock, remove the top part of the key and use it to lock the vehicle.
- If you open the driver's door while the ignition is switched on, a warning buzzer will sound, and the message **Ignition is on** will appear in the display. In this case, please switch off the ignition. ■

**Switching off the engine**

- Stop the vehicle.
- Automatic gearbox: Move the selector lever to position P or N.
- **Press in** the ignition key to switch off the engine.

**Emergency Off function**

If necessary in an emergency, the engine can be switched off while the vehicle is still moving. The engine will be switched off if you press and hold the ignition key.

**! WARNING**

- **Never switch off the engine until the vehicle is stationary.**
- **The brake servo and the power steering system work only when the engine is running. You need more strength to steer and brake the vehicle when the engine is switched off. This would mean a greater risk of accidents and serious injury, because you cannot steer and brake in the normal manner.**

**! Caution**

If the engine has been working hard for a long time, there is a risk of heat building up in the engine compartment after the engine has been switched off; this could cause engine damage. For this reason,

you should leave the engine idling for about 2 minutes before switching it off.

**i Note**

After the engine is stopped the radiator fan may run on for up to 10 minutes, even if the ignition is switched off. The fan may also start running again after some time if the coolant temperature rises due to a build-up of heat, or if the engine is hot and the engine compartment is heated up further by direct sunlight. ■

**Starting and stopping the engine with the advanced key**

Applies to vehicles: with advanced key

**Starting the engine with the Start/Stop button**



*You can use the Start/Stop button to switch on the ignition and start the engine.*



Fig. 131 Audi advanced key: START ENGINE STOP button

- **Manual gearbox:** Press the clutch pedal all the way down and move the gear lever into neutral. ▶



- **Automatic gearbox:** Press the brake pedal and move the selector lever to position P or N ⇒ .
- **Press** the Start/Stop button ⇒ *page 118*, fig. 131 to start the engine.
- Diesel engines can take a few seconds longer than usual to start on cold days. Please keep your foot on the clutch or brake pedal until the engine starts. The glow plug indicator lamp  lights up in the instrument cluster while the glow plugs are preheating.

If you press the Start/Stop button without pressing the clutch or brake pedal, the ignition will be switched on (and will be switched off if you press the button again). Diesel engines are preheated when the ignition is switched on.

If the engine fails to start straight-away, switch off the starter after about 10 seconds and try again after about half a minute.

When starting from cold the engine may be a little noisy for the first few seconds until oil pressure has built up in the hydraulic tappets. This is quite normal and no cause for concern.

#### Driver message in the instrument cluster display

##### No key identified

This message appears when you press the Start/Stop button if there is no remote control key inside the vehicle or if the system cannot detect or identify the key. This can happen, for example, if the radio signal from the key is *obstructed* by a metal briefcase or similar. Electronic equipment, such as mobile phones, can also interfere with the radio signal from the key.

##### Press brake pedal to start engine

This message appears on automatic vehicles if you press the Start/Stop button to start the engine without first pressing the brake pedal. The engine will only start if you press the brake pedal.

##### Press clutch pedal to start engine

This message appears on manual vehicles if you press the Start/Stop button to start the engine without first pressing the clutch pedal. The engine will only start if you press the clutch pedal.

##### Engage N or P to start engine

This message will appear if you try to start the engine when the selector lever of the automatic gearbox is not in P or N. The engine can only be started if the selector lever is in one of these positions.

##### Key not in vehicle

This message will appear together with the symbol  if the remote control key is removed from the vehicle while the engine is running. This is to remind you not to continue driving without the key (for example if you change drivers).

If the remote control key is not in the vehicle you will not be able to switch on the ignition or restart the engine after it has been switched off. Without the key, you will also not be able to lock the vehicle from the outside.

**Shift to P, otherwise vehicle can roll away. Doors do not lock if lever is not in P. or Please move selector lever to position P. Vehicle cannot be locked.**

For safety reasons, this message will appear and a warning buzzer will sound if the selector lever of the automatic gearbox is not in position P when you switch off the ignition with the Start/Stop button. Put the selector lever in position P; otherwise the vehicle can roll away. If the lever is not in position P you will not be able to lock the vehicle using the exterior locking switch on the door handle or the remote control key.

##### Advanced key defective! Use ignition lock

This message appears if the vehicle has to be started with the ignition key instead of the Start/Stop button. ►

**Steering lock**

The steering is locked if the key is not in the ignition and the driver door has been opened. The steering lock acts as a theft deterrent.

**WARNING**

**Never run the engine in confined spaces. The exhaust gases are toxic.**

- **Never switch off the engine until the vehicle is stationary.**
- **The brake servo and the power steering system work only when the engine is running. You need more strength to steer and brake the vehicle when the engine is switched off. This would mean a greater risk of accidents and serious injury, because you cannot steer and brake in the normal manner.**

**Caution**

- Avoid high engine speeds, full throttle and extreme load conditions until the engine has reached its normal operating temperature, otherwise this can damage the engine.
- The engine cannot be started by push-starting or towing.
- If the engine has been working hard for a long time, there is a risk of heat building up in the engine compartment after the engine has been switched off; this could cause engine damage. For this reason, you should leave the engine idling for about 2 minutes before switching it off.

**Note**

If you open the driver's door while the ignition is switched on, a warning buzzer will sound, and the message **Ignition is on** will appear in the display. In this case, please switch off the ignition. ■

**Switching off the engine with the Start/Stop button**

- Stop the vehicle.
- Automatic gearbox: Move the selector lever to position P or N.
- **Press** the Start/Stop button ⇒ *page 118, fig. 131.*

**Emergency Off function**

Should it be necessary in an emergency, the engine can be switched off when the selector lever is in position R, D or S. To switch off the engine (max. speed 10 km/h) press and hold the Start/Stop button and keep your foot on the brake.

**WARNING**

- **Never switch off the engine until the vehicle is stationary.**
- **The brake servo and the power steering system work only when the engine is running. You need more strength to steer and brake the vehicle when the engine is switched off. This would mean a greater risk of accidents and serious injury, because you cannot steer and brake in the normal manner.**

**Caution**

If the engine has been working hard for a long time, there is a risk of heat building up in the engine compartment after the engine has been switched off; this could cause engine damage. For this reason, you should leave the engine idling for about 2 minutes before switching it off.

**Note**

After the engine is stopped the radiator fan may run on for up to 10 minutes, even if the ignition is switched off. The fan may also ►

start running again after some time if the coolant temperature rises due to a build-up of heat, or if the engine is hot and the engine compartment is heated up further by direct sunlight. ■

## Electro-mechanical parking brake

### Operation

The electro-mechanical parking brake replaces the handbrake.

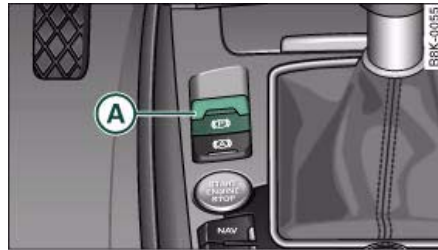

Fig. 132 Centre console: Parking brake

- Pull switch (A) ⇒ fig. 132 to apply the parking brake. The indicator lamp in the switch will light up.
- Depress the brake or accelerator pedal and press the switch at the same time to release the parking brake. The indicator lamp in the switch will go out.

Your vehicle is equipped with an electro-mechanical parking brake. The parking brake replaces the conventional handbrake, and is mainly intended to prevent the vehicle from rolling away accidentally.

However, the electro-mechanical parking brake also offers a number of convenience and safety features in addition to the functions of a normal handbrake.

### When driving away

- The parking brake auto release function releases the parking brake automatically when you wish to start moving ⇒ page 122, "Driving away from a standstill".
- When driving away on a gradient, the parking brake auto release function prevents the vehicle from rolling back unintentionally. The braking force of the parking brake is only released when there is enough power at the wheels to make the vehicle move in the desired direction.

### Emergency braking function

An emergency braking function enables you to stop the vehicle even if the *conventional* foot brake should fail to work ⇒ page 123, "Emergency braking function".

### Warning and indicator lamps

- The warning lamps (P) in the instrument cluster and in the switch light up when the parking brake is applied with the ignition **switched on**.
- The warning lamps (P) in the instrument cluster and switch light up for approximately 20 seconds when the parking brake is applied with the ignition **switched off**.

### ! WARNING

**Never press the accelerator pedal or release the clutch inadvertently if a gear is engaged or if the selector lever is not in position P or N (on automatic vehicles) while the vehicle is stationary with the engine running. The vehicle could otherwise start moving immediately and possibly cause an accident.**

### ! Caution

If the symbol (P) flashes in the centre display, or if the warning lamp (P) flashes in the instrument cluster, there is a fault in the brake system. You can press the (SET) button to obtain a message explaining the fault. If the message **Parking brake!** appears, there is ►

a fault in the parking brake. Have the fault repaired by a qualified workshop without delay ⇒ *page 32*.

### Note

- The parking brake can be applied at any time - even when the ignition is switched off. However, the ignition must be switched on before the parking brake can be released.
- Any slight noise which may be heard when the parking brake is applied or released is quite normal and no cause for concern.
- The parking brake runs an automatic test cycle at regular intervals when the vehicle is parked. This may also cause a slight noise, which is normal. ■

### Parking

*Please note the following points to ensure there is no risk of the car rolling away accidentally after it is parked.*

#### Parking the car

- Use the foot brake to stop the vehicle.
- Pull the switch to apply the parking brake.
- Automatic gearbox: Move the selector lever to P.
- Switch off the engine ⇒ .
- Manual gearbox: Engage the first gear.

#### When parking on slopes

- Turn the steering wheel so that the vehicle would roll into the kerb if it did start to move accidentally.

### WARNING

- **Always take the key with you when leaving the vehicle – even if you only intend to be gone for a short time. This is especially important if children are left in the car. They might otherwise be able to start the engine, release the parking brake or use power-operated equipment such as the electric windows - this could lead to injuries.**
- **Do not leave anyone (especially children) in the vehicle when it is locked. Locked doors could delay assistance in an emergency, potentially putting lives at risk. ■**

### Driving away from a standstill

*The parking brake auto release function releases the parking brake automatically when you wish to start moving.*

#### Applying the parking brake when stopping

- Pull the switch to apply the parking brake.

#### Releasing the parking brake when driving away

- Drive off in the normal way: the parking brake will be released automatically and the vehicle will start moving.

On vehicles with automatic gearbox, you can apply the parking brake when stopping at traffic lights, etc. Then you do not have to hold the car with the footbrake, as the parking brake will stop it creeping forward while a gear is engaged in the automatic transmission. When you drive off in the normal way, the parking brake will be released automatically and the vehicle will start moving.

#### Driving away on a slope

When driving away on a gradient, the parking brake auto release function prevents the vehicle from rolling back unintentionally. The ►

braking force of the parking brake is only released when there is enough power at the wheels to make the vehicle move in the desired direction.



#### Note

For safety reasons the parking brake will only release automatically if the driver's seat belt is engaged in its buckle. ■

### Driving away when towing a trailer

*Please note the following points to prevent the vehicle from rolling back unintentionally on a gradient.*

- Pull and hold the parking brake switch and press the accelerator. The parking brake will remain engaged and prevent any tendency to roll back down the slope.
- You can release the parking brake switch as soon as the engine is delivering enough power to the wheels.

Depending on the weight of the vehicle and trailer and the steepness of the slope, there may be a tendency to roll back downhill when driving away from a standstill. You can prevent this by pulling out the parking brake switch as you press the accelerator (in the same way as with a conventional handbrake). ■

### Emergency braking function

*This feature enables you to stop the vehicle if the main brake system should fail or if the pedal is obstructed.*

- Pull out and hold the parking brake switch to stop the vehicle with the parking brake in an emergency.
- The brakes will be released immediately if you release the switch or press down the accelerator.

If you pull out and hold the parking brake switch at a road speed above about 8 km/h, this will initiate an emergency brake application. The brakes are then applied hydraulically at all four wheels. The effect is the same as an emergency stop (full brake application) ⇒ ⚠

To prevent the emergency braking function from being used accidentally, a warning buzzer sounds when the switch is operated. The brakes are released immediately when you release the switch or press down the accelerator.

#### ⚠ WARNING

**You should only use the emergency braking function in a real emergency, for example if the brake system should fail or if the brake pedal is obstructed. If you use the emergency braking function by activating the parking brake switch, the effect is similar to a full brake application (emergency stop). Please remember that the ESP (with its combined ABS, EDL and traction control functions) is still subject to certain physical limits. In a corner or in bad road or weather conditions an emergency stop can cause the vehicle to skid or lose steering control. ■**

### Driver messages in the instrument cluster display

#### Caution: Vehicle parked too steep

This message can appear when you apply the parking brake if the car is parked on a gradient steeper than about 30%.

In this case the parking brake **may not be strong enough** to prevent the vehicle from rolling back accidentally.

#### Please release parking brake

However, please remember that, for safety reasons, the parking brake will only release automatically if the driver's seat belt is buckled. ▶

**Press brake pedal to release parking brake**

This message may appear when you press the switch to release the parking brake. The parking brake can only be released, if you depress the brake pedal and simultaneously press the switch or if you use the parking brake auto release function ⇒ *page 122*.

**🚫 Parking brake malfunction !**

This message will appear together with the yellow symbol 🚫 if a malfunction should occur in the parking brake.

**Fault in parking brake auto release**

This driver message will appear in the event of a malfunction of the parking brake auto release. The automatic release of the parking brake when moving off from a standstill is not functioning correctly. The parking brake must be released manually by pressing the switch. Have the fault rectified by a qualified workshop. ■

Applies to vehicles: with Audi hold assist

**Audi hold assist**

*Audi hold assist helps the driver when the vehicle is stationary and automatically prevents the vehicle from rolling away when driving off.*

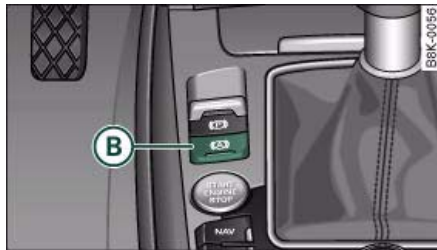

**Fig. 133** Detail of the centre console: Button for Audi hold assist

When the Audi hold assist function is on, the vehicle is automatically prevented from rolling away and you no longer have to keep your foot on the brake pedal.

**Conditions for switching on Audi hold assist**

- The driver's door must be closed.
- The driver's seat belt must be buckled.
- The engine must be running.

**Switching on Audi hold assist**

- Press button **B** ⇒ fig. 133 in the centre console to switch on the Audi hold assist function. The indicator lamp in the switch will light up.

**Switching off Audi hold assist**

- Press button **B** ⇒ fig. 133 to switch off the Audi hold assist function. The indicator lamp in the switch will go out.
- If you press button **B** while the vehicle is being held by the Audi hold assist function, the electro-mechanical parking brake **P** will automatically take over. The parking brake will not take over if the foot brake is applied simultaneously.
- Audi hold assist is switched off automatically if you open the driver's door, unbuckle the seat belt or switch off the engine. If this happens when the green symbol **B** is displayed in the instrument cluster, the parking brake will be applied automatically to ensure that the vehicle is parked safely.

Audi hold assist helps the driver to keep the vehicle stationary while the engine is running, for instance on steep gradients, at traffic ►

lights or in stop-and-go traffic. When the Audi hold assist function is on, you don't have to keep your foot on the brake to prevent the vehicle from accidentally rolling away. Once it detects that the vehicle is stopped, Audi hold assist keeps the vehicle stationary. The green symbol  in the instrument cluster indicates that the function is activated. You can now take your foot off the brake pedal.

As soon as you drive off in the normal way, the parking brake will automatically be released and the vehicle will start moving.

If the conditions for Audi hold assist change and the function is switched off as a result, the parking brake will be applied automatically to ensure that the vehicle is parked safely. The diode in the button will go out when the Audi hold assist function is switched off.

#### WARNING



The intelligent technology in Audi hold assist cannot defy the laws of physics. Do not let the extra convenience provided by Audi hold assist tempt you into taking a safety risk.

- Audi hold assist cannot keep the vehicle stationary in all conditions on a gradient (e.g. if the road is slippery or icy).
- Audi hold assist must be switched on again each time the engine is started – Risk of accident!
- Never get out of the vehicle when the engine is running and Audi hold assist is switched on – Risk of accident!
- Always ensure that the vehicle is stopped properly and safely to avoid injury to yourself and others.

#### Caution

Switch off the Audi hold assist function before driving the vehicle into a car wash.

#### Note

- Audi hold assist can be switched on only when the driver's door is closed, the driver's seat belt is buckled and the engine is running.
- Audi hold assist prevents automatic vehicles from creeping forwards when the brake pedal is released with the car in gear.
- When the vehicle has been stationary for an extended period, Audi hold assist will automatically apply the parking brake. In this case, the green symbol  in the instrument cluster display will change to red . ■

## Cruise control system

Applies to vehicles: with cruise control system

### Switching on

The cruise control system allows you to drive at a constant speed of 30 km/h or higher.

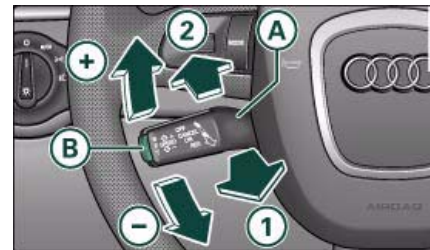



Fig. 134 Control lever and pushbutton



Fig. 135 Display:  
Selected speed

- Pull the lever **A** to position **1** ⇒ page 125, fig. 134 to switch on the system.
- Drive at the speed you wish to set the system to.
- Press the button marked **B** to store the speed.

The display will indicate the stored speed, and the green symbol  will appear ⇒ fig. 135. The display can vary according to the display status. In addition, the indicator lamp  in the instrument cluster will light up.

A constant speed is maintained by adjusting the engine power or braking the vehicle accordingly.

#### WARNING

- **Always direct your full attention to the road, even when you are using the cruise control system. It is always the driver who is responsible for determining the speed and for keeping a safe distance to the other vehicles on the road.**
- **For safety reasons, the cruise control system must not be used in city traffic, stop-and-go traffic, roads with a lot of bends or in difficult driving conditions (such as ice, fog, loose grit or gravel, heavy rain, aquaplaning) - this could cause an accident!**

#### WARNING (continued)

- **When you take a turn-off, drive along a motorway exit lane or pass through roadwork sections, please temporarily switch off the cruise control system.**
- **Please make sure you do not unintentionally rest your foot on the accelerator - this will override the cruise control system which, as a result, will not brake the vehicle.**

#### Note

- Vehicles with manual gearbox: The set speed cannot be reached if the currently selected gear is too high or too low. Change down to a lower gear if the engine is no longer running smoothly or change up a gear to avoid overrevving the engine.
- The brake lights come on when the system brakes the vehicle. ■

Applies to vehicles: with cruise control system

#### Adjusting the speed

- Push the lever **A** up towards **+** or down towards **-** ⇒ page 125, fig. 134 in order to increase or reduce the cruising speed setting.
- Release the lever to store the current cruising speed.

You can alter the set speed in steps of 1 km/h by briefly pressing the lever upwards or downwards. When you press and hold the lever, the speed is changed in steps of 10 km/h.

You can still use the accelerator pedal to increase speed in the normal way, for example to overtake another vehicle. Once you release the accelerator, the system will revert to the speed you stored initially.

However, if the vehicle exceeds the programmed speed by more than 10 km/h for more than 5 minutes, the cruise control system will ►



be deactivated temporarily. The green symbol in the display will change to white but the stored speed will be retained. ■

Applies to vehicles: with cruise control system

### Pre-selecting a speed

*You can pre-select a desired speed while the vehicle is stationary.*

- Switch on the ignition.
- Pull the lever (A) to position 1 ⇒ *page 125, fig. 134.*
- Push the lever up towards (+) or down towards (-) in order to increase or reduce the cruising speed setting.
- Release the lever to store the cruising speed setting displayed.

This function allows you to enter the desired cruise control setting speed ahead of time, for example before joining a motorway. Once you are on the motorway, you can activate the cruise control system by pulling the lever to position (1). ■

Applies to vehicles: with cruise control system

### Switching off the cruise control system

#### Switching off temporarily

- Press the brake pedal, or
- Manual gearbox: Press the clutch pedal for a *relatively long* period, or
- Push lever (A) to position (2) (click stop not engaged) ⇒ *page 125, fig. 134, or*

- Drive more than 10 km/h faster than the stored speed over a period of more than 5 minutes.

#### Switching off completely

- Press the lever (A) to position (2) (click stop engaged), or
- Switch off the ignition.

The speed setting will remain stored after the system is temporarily deactivated. To resume the programmed cruising speed, release the clutch or brake pedal and pull the lever to position (1).

The stored speed will be deleted once the ignition is switched off.

#### WARNING

**Do not resume the programmed cruising speed if this is too high for the traffic conditions - this can cause accidents. ■**

## adaptive cruise control (ACC)

### Speed and distance control system

Applies to vehicles: with adaptive cruise control

#### Description

*The adaptive cruise control is a combined speed and distance control system to assist the driver.*

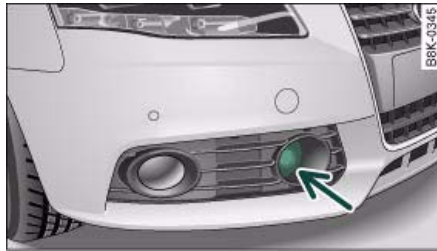

Fig. 136 Trim grille (front right): Position of radar sensor

Adaptive cruise control allows you to maintain any desired constant speed between 30 and 200 km/h. In addition, the system controls the distance maintained to the vehicle in front (subject to certain limitations as described below).

The system can be used to greatest effect on long motorway journeys or on other main roads with long straight sections.

#### How is the system operated?

The adaptive cruise control system is operated via a control lever on the steering wheel ⇒ *page 131*, "Setting the speed" and ⇒ *page 133*, "Setting the distance".

#### Driver messages

When the system is being used, important information is displayed in the speedometer and on the instrument cluster display screen ⇒ *page 134*, "Driver messages".

#### Please note the following points:

The adaptive cruise control has certain limits determined by the system itself. This means that the driver may in some situations have to intervene and control the speed and distance to the vehicle in front himself ⇒ *page 138*, "Driver intervention prompt" and ⇒ *page 140*, "System limitations".

#### WARNING

**Please always direct your full attention to the road, even when you are using adaptive cruise control. It is always the driver who is responsible for determining the speed and for keeping a safe distance to the other vehicles on the road.**

- For safety reasons, the adaptive cruise control must not be used in city traffic, stop-go traffic, roads with a lot of bends or in difficult driving conditions (such as ice, fog, loose grit or gravel, heavy rain, aquaplaning) - this could cause an accident!
- When you take a turn-off, drive along a motorway exit lane or pass through roadwork sections, please temporarily switch off the adaptive cruise control in order to avoid the vehicle accelerating to the selected speed.
- The adaptive cruise control can only control the distance to vehicles in front. As a rule, it cannot recognize vehicles travelling in other lanes. For this reason, please temporarily switch off the system if you are travelling in the inside lane and vehicles in the overtaking lane are travelling at a slower speed than you are. Otherwise, you would overtake these vehicles on the inside.

**WARNING (continued)**

- Adaptive cruise control will not react when approaching a stationary obstacle, e.g. the end of a traffic jam or a broken-down vehicle, or if a vehicle should come towards you in the same lane.
- Please make sure you do not unintentionally rest your foot on the accelerator - this will override the adaptive cruise control system which, as a result, will not automatically brake the vehicle.

**Note**

- For safety reasons, the speed setting will be deleted when the ignition is switched off.
- Switching on the adaptive cruise control automatically activates the Electronic Stabilisation Program (ESP) and the traction control system (ASR). These two systems cannot be deactivated while the adaptive cruise control is switched on.
- Damage caused by impacts (e.g. if the vehicle is damaged when parking) can affect the radar sensor settings. This can cause the system to malfunction or switch off completely.
- The radar sensor is heated. However, in winter conditions, you should make sure that the radar sensor is free of ice and snow before you set off. If necessary, carefully clean the cover of the radar sensor and the surrounding area ⇒ page 128, fig. 136.
- To make sure that the radar sensor is fully operative, do not attach any objects (e.g. stickers, add-on parts or other accessories) to the area surrounding the radar sensor. Do not paint the area surrounding the radar sensor. ■

Applies to vehicles: with adaptive cruise control and manual gearbox

**Vehicles with manual gearbox**

*The driver of a vehicle with a manual gearbox of course has to change gears as appropriate, even when the adaptive cruise control is activated.*

The **adaptive cruise control** is available from the **second** to the **sixth** gear (when driven in normal engine speed range).

When the adaptive cruise control is activated, the driver must press the clutch pedal as normal in order to change gear. When changing gear or pressing the clutch pedal (for up to 20 seconds), the adaptive cruise control will remain activated.

When changing gear, the driver does **not** have to accelerate after engaging a gear as the engine torque will be coordinated by the adaptive cruise control.

The following situations may lead to an **automatic deactivation** of the **adaptive cruise control**:

- pressing the clutch pedal too long (longer than approx. 20 seconds)
- incorrect changing of gears and/or use of the clutch pedal

**Note**

- The adaptive cruise control cannot be activated while changing gears. ■

Applies to vehicles: with adaptive cruise control

### How does the distance control work?

*Vehicles in front are detected by a radar sensor.*

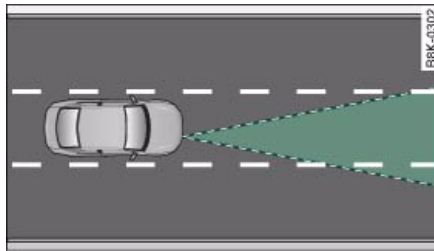

Fig. 137 Area covered by radar sensor

The adaptive cruise control uses a radar sensor ⇒ fig. 137 which is integrated in the front of the vehicle and is subject to certain system limitations ⇒ *page 140*. Stationary objects are disregarded. The system requires reflecting surfaces in order to be able to measure the distance. If the ACC is unable to measure the distance it will not respond.

#### No vehicle in front

When there is no vehicle in front, the adaptive cruise control works like a speed control system. It maintains a constant target speed specified by the driver.

#### Vehicle in front

If you catch up with a vehicle driving in front, the adaptive cruise control will reduce the speed accordingly (within the limits set by the system ⇒ *page 138*, "Driver intervention prompt" and ⇒ *page 140*, "System limitations") and adapt it to the speed of the vehicle in front. Then the system will try to adjust the distance to the car in front according to the settings selected. During the adjustment process the system may temporarily not be able to adhere to the distance you had specified ⇒ ⚠ in "Description" on *page 128*.

If the vehicle in front accelerates, the adaptive cruise control will also accelerate, up to the target speed you have specified.

#### Driver intervention prompt

In some situations, it is necessary for the driver to brake the vehicle with the foot brake in order to keep a safe distance to the vehicle in front or to avoid a collision. In this case, a warning message will appear in the display and you will also hear a warning tone ⇒ *page 138*.

#### When overtaking

When you move into the overtaking lane and no vehicle is detected in front, the adaptive cruise control will accelerate up to the target speed and then maintain it.

#### Overriding

You can still use the accelerator pedal at any time to increase speed in the normal way. The previously programmed speed will be resumed when the accelerator pedal is released.

#### **i** Note

- Please note that acceleration will vary depending on the preset programme. If you have, for example, selected "Distance 1" and the driving programme "dynamic", acceleration will be more "sporty". However, if you have set the system to "Distance 4" and driving programme "comfort", acceleration will be more gradual. For a detailed description please refer to ⇒ *page 133*, "Setting the distance".
- *No vehicle in front, Vehicle in front* and a *Driver intervention prompt* will be indicated by an indicator lamp ⇒ *page 134*, "Indicator lamp and display in the speedometer". ■

Applies to vehicles: with adaptive cruise control

### Switching the system on and off

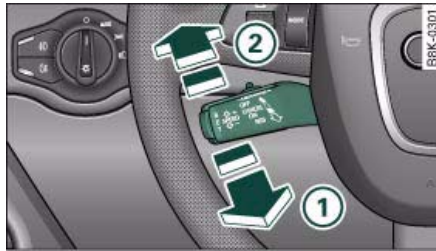

Fig. 138 Control lever for: Switching the system on and off

- Pull the control lever to position ① ⇒ fig. 138 to switch on the system.
- Press the control lever to position ② (click stop engaged) to switch the system off. ■

Applies to vehicles: with adaptive cruise control

### Setting the speed



Fig. 139 Control lever for: Setting speed

Important: The system must be switched on.

- Drive at the desired speed. The speed must be in the range between 30 and 200 km/h.
- Press the **SET** button -arrow- ⇒ fig. 139 to confirm the target speed you wish to store.

When the **SET** button is released, the current speed is stored in the memory and the vehicle will then maintain this speed.

One or two red diodes will light up in the speedometer dial ⇒ page 134 to mark the speed which is currently stored in the system. At the same time, the speed will briefly be displayed in the system status indicator ⇒ page 136.

#### **i** Note

For safety reasons, the speed setting will be deleted when the ignition is switched off. ■

Applies to vehicles: with adaptive cruise control

### Setting a new speed

*The speed can be altered without touching the accelerator or the brake.*

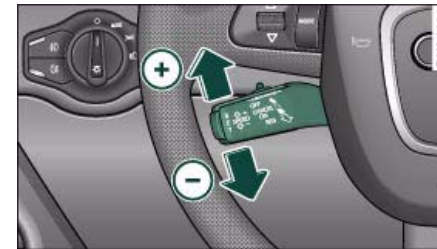

Fig. 140 Control lever for: Setting a new speed

### Setting a higher speed

- **Briefly** move the control lever up towards  $\oplus$   $\Rightarrow$  fig. 140. The speed will be incremented by one graduation on the scale in the speedometer.
- Press the control lever up towards  $\oplus$  and **hold** it in this position. The speed setting is indicated by the diodes in the speedometer; the speed will be increased accordingly.

### Setting a lower speed

- **Briefly** move the control lever down towards  $\ominus$ . The speed will be reduced by one graduation on the scale in the speedometer.
- Press the control lever down towards  $\ominus$  and **hold** it in this position. The speed setting is indicated by the diodes in the speedometer; the speed will be reduced accordingly.

After releasing the control lever, the system will adapt your speed to the setting you have selected.

Following any changes, the new stored speed will be displayed briefly in the system status indicator  $\Rightarrow$  page 136.

#### Note

You can still use the accelerator pedal at any time to increase speed in the normal way. The previously programmed speed will be resumed when the accelerator pedal is released. You can set a new speed at any time by pressing the **SET** button  $\Rightarrow$  page 131, fig. 139. ■

Applies to vehicles: with adaptive cruise control

### Switching off the system (with speed memory function) and reactivating it

*In some situations it makes sense to switch off the system.*



Fig. 141 Control lever for: Switching off the system (with speed memory function) and reactivating it

#### Switching off the system (with speed memory function)

- Press the brake pedal, or
- Press the control lever in direction  $\textcircled{2}$   $\Rightarrow$  fig. 141.

#### Reactivating the system

- Release the brake pedal and pull the lever in direction  $\textcircled{1}$ .

#### WARNING

**It is dangerous to resume a set speed which is too high for the current road, traffic or weather conditions - risk of accident.**

#### Note

When switching off the system (with speed memory function) the speed stored at this point remains in the memory. ■

Applies to vehicles: with adaptive cruise control

### Setting the distance

The distance can be set in 4 different stages.

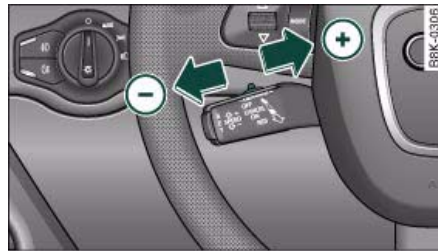

Fig. 142 Control lever for: Setting the distance

- Briefly press the sliding switch ⇒ fig. 142 **once** towards ⊕ or ⊖. The display in the instrument cluster will briefly show the current distance setting.
- Press the sliding switch **again** towards ⊕ or ⊖ to increase or reduce the distance by one level at a time.

### Choosing the distance

The adaptive cruise control system determines the distance to the vehicle in front by **time intervals**. It defines a time-based distance to the vehicle in front which is kept at a constant level. This converts to a distance which depends on the speed - the higher the speed, the higher the safety distance in metres ⇒ ⚠.

The actual distance maintained by the adaptive cruise control can be longer or shorter, depending on the traffic situation and the driving style of the driver in front.

#### Distance 1

This setting is suitable for brisk driving in a line of traffic. The time interval is 1 second. This is equivalent to (for instance):

- A distance of 14 metres at a speed of 50 km/h

- A distance of 36 metres at a speed of 130 km/h

#### Distance 2

This setting is suitable for relaxed “moving with the flow” in a line of traffic. The time interval is 1.3 seconds. This is equivalent to (for instance):

- A distance of 18 metres at a speed of 50 km/h
- A distance of 47 metres at a speed of 130 km/h

#### Distance 3

This (recommended) setting is suitable for relaxed “moving with the flow” in a line of traffic. The time interval is 1.8 seconds. This is equivalent to (for instance):

- A distance of 25 metres at a speed of 50 km/h
- A distance of 65 metres at a speed of 130 km/h

#### Distance 4

This setting is suitable for single-carriageway roads. The time interval is 2.3 seconds. This is equivalent to (for instance):

- A distance of 32 metres at a speed of 50 km/h
- A distance of 83 metres at a speed of 130 km/h

You can control the acceleration and braking response of your vehicle in adaptive cruise control mode by adjusting the settings on the sound system or MMI\* ⇒ page 139. Depending on the driving program and distance selected, acceleration and braking response will range from dynamic (1) to relaxed (5).

Driving program	dynamic	standard	comfort
Distance 1	1	2	3
Distance 2	2	3	4
Distance 3	2	3	4
Distance 4	3	4	5

**! WARNING**  
**When setting the distance, the driver is responsible for adhering to the laws and regulations which apply in the country he is travelling in. ■**

### Driver messages

Applies to vehicles: with adaptive cruise control

#### Messages in the instrument cluster

The instrument cluster displays various driver messages.

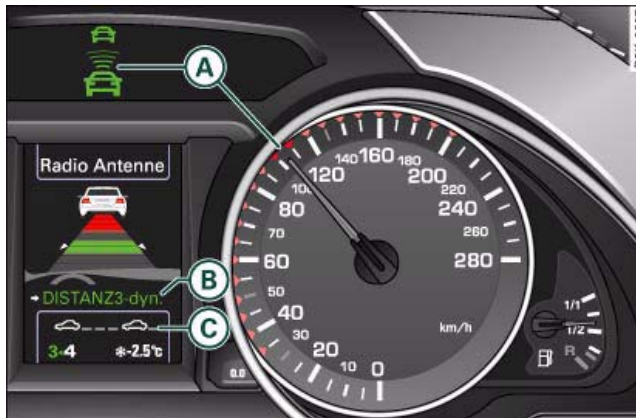

Fig. 143 Overview of instrument cluster

- (A) Indicator lamp and speedometer display
- (B) Instrument cluster display
- (C) System status indicator

#### (A) Indicator lamp and speedometer display

Section (A) of the display shows important information regarding the use of the adaptive cruise control system. The target speed you have set is marked by diodes in the speedometer.

The indicator lamp shows whether the system has detected a vehicle in front.

#### (B) Instrument cluster display

You can call up the display for the adaptive cruise control by repeatedly pressing the **RESET** button on the windscreen wiper lever. For more details refer to ⇒ page 27.

#### (C) System status indicator

The information in section (C) of the display is not shown permanently. It only appears if you, for example, set or change the speed setting, change the time interval, when messages are displayed, or if the adaptive cruise control is switched off for safety reasons. ■

Applies to vehicles: with adaptive cruise control

#### Indicator lamp and display in the speedometer

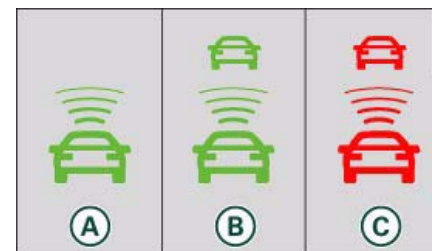

Fig. 144 Instrument cluster: Indicator lamp ▶



### Target speed

The target speed set by the driver is indicated by a red diode in the speedometer.

If the speed setting is between two graduations on the speedometer dial, the two closest diodes will both light up ⇒ fig. 143.

It is only possible to set target speeds ranging from 30 to 200 km/h. This speed range is illuminated slightly by the diodes on the speedometer dial.

### Indicator lamp (symbol)

- **A No vehicle in front:** The green indicator lamp **A** ⇒ page 134, fig. 144 shows that the adaptive cruise control system is in cruise mode and that there is no vehicle in front. It maintains the stored target speed.
- **B Vehicle in front:** The green indicator lamp **B** shows that the system has detected a vehicle in front. The speed is adapted to the vehicle in front. The adaptive cruise control system accelerates and brakes the vehicle automatically.
- **C Driver intervention prompt:** When the red indicator lamp flashes **C**, this is a **warning for the driver to intervene**. The driver has to brake the vehicle with the foot brake. This warning lamp will always appear when the adaptive cruise control system alone is not able to brake the vehicle sufficiently to maintain a safe distance to a vehicle in front. An audible alarm (warning tone) will also sound when the lamp starts to flash. For further information on the driver intervention prompt ⇒ page 138.

### Note

- If you exceed the target speed by using the accelerator, the **driver intervention prompt** will not be accompanied by a warning tone. The indicator lamp shown in the speedometer will also switch off if the target speed is exceeded.
- You can change the volume of the warning tone on the sound system or MMI\* ⇒ page 139, "Setting the warning tone volume and driving program". ■

Applies to vehicles: with adaptive cruise control

### Instrument cluster display

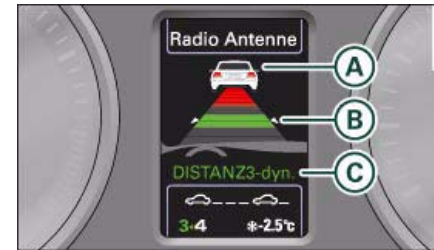

Fig. 145 Instrument cluster: Display

Repeatedly press the **(RESET)** button on the windscreen wiper lever to select whether you wish to display information regarding the on-board computer, the navigation system\* or the adaptive cruise control in this section of the display screen.

- A** Vehicle image
- B** Distance
- C** System status

#### **A** Vehicle image

The vehicle image will show you whether the system has detected a vehicle in front.

- **Vehicle outlined:** No vehicle in front
- **Vehicle in white:** A vehicle in front has been detected
- **Vehicle in red:** Driver intervention prompt

#### **B** Distance

The arrows and scale indicate the distance to the vehicle in front.

- **No vehicle in front:** If there is no vehicle in front, no arrows will be shown. ▶

- **Vehicle in front:** If a vehicle is detected in front, the arrows will be on the scale. The green area of the scale represents the distance setting. If you approach the vehicle in front slowly, the arrows will move from the **grey** area into the **green** area of the scale.
- **Driver intervention prompt:** If you approach the vehicle in front quickly, the arrows act as a warning. When the actual distance is shorter (or is likely to become shorter) than the distance selected, the arrows move into the **red** area of the scale. In certain situations, you may need to intervene as the driver ⇒ page 138, "Driver intervention prompt".

### Ⓢ Status

- **ACC OFF** (in white letters): The adaptive cruise control is switched off.
- **ACC AVAILABLE** (in white letters): The system is switched on but the control has not yet been activated.
- **OVERRIDE** (in white letters): You have exceeded the target speed by accelerating.
- **DISTANCE!** (in red letters): The distance to the vehicle in front is not sufficient and you have to brake the vehicle with the foot brake.
- **DISTANCE 1 to DISTANCE 4** (in green letters): Shows the time interval you have selected. The adaptive cruise control is in cruise mode.
- **DISTANCE 1 - dyn., DISTANCE 1 - comf.** etc. (in green letters): If the settings are adjusted on the sound system or MMI\* such that the "standard" driving program is replaced by "comfort" or "dynamic", the message above will indicate the setting. ■

Applies to vehicles: with adaptive cruise control

### System status indicator in the instrument cluster display

*The text messages and symbols in this section of the display are not shown permanently.*



Fig. 146 Instrument cluster: Further information

### Time intervals (e.g. ☁---☁)

The various symbols for the **time intervals** -arrow- ⇒ fig. 146 appear when you change the settings.



The symbol  indicates that the warning tone has been switched off.

...

The text message ... (three white dots) appears if a setting made with the control lever cannot be implemented. There can be several reasons for this:

- You have pulled the control lever towards you to resume the programmed cruising speed, without a target speed having been set.
- The control lever has been pushed up / down to increase / reduce the speed, without a target speed having been set. ▶

- The control lever has been pushed up / down to increase / reduce the speed, but the resulting speed would be outside the range of 30 to 200 km/h.

#### ACC deactivation

The message **ACC deactivation** sometimes appears on vehicles with a manual gearbox. If you press the clutch pedal for longer than about 20 seconds, the adaptive cruise control will be automatically deactivated and a warning tone will sound.

#### ACC not available

The text message **ACC not available** will appear if, for example, the brakes are overheated. The adaptive cruise control will then temporarily not be available. This is indicated by a warning tone.

#### ACC not available!

The text message **ACC not available!** appears if a malfunction should occur. The adaptive cruise control will then be switched off. This is indicated by a warning tone. Have the system checked by a qualified workshop.

#### ACC sensor blocked!

The text message **ACC sensor blocked!** appears if the ACC system can no longer detect objects reliably. The adaptive cruise control will then be switched off. This is indicated by a warning tone.

The ACC sensor is obstructed by dirt or foreign objects (e.g. leaves or snow). Clean the sensor to restore the function ⇒ *page 128*, fig. 136.

#### Engine speed !

On vehicles with manual gearbox, the text message **Engine speed !** will appear if the driver does not change gear in time when the adaptive cruise control accelerates or brakes the vehicle. The adaptive cruise control will automatically be deactivated if the engine speed is not maintained within the permissible range. This is indicated by a warning tone.

#### ESP activation

The text message **ESP activation** appears if the Electronic Stabilisation Programme (ESP) has intervened. In this case, the adaptive cruise control will automatically be switched off. This is indicated by a warning tone.

#### Speed (in km/h)

The target speed (in km/h) will appear in the display whenever it is stored or changed ⇒ *page 131*, "Setting the speed" and ⇒ *page 131*, "Setting a new speed".

#### Speed range

The text message **speed range** appears if the current speed is too low **to set** or **to maintain** the target speed.

To set a target speed, the speed of the vehicle must be at least 30 km/h. The cruise control system switches off if the speed falls below 20 km/h.

If the speed exceeds 200 km/h (OVERRIDE), the system will remain active and will reduce the speed to 200 km/h once the driver stops accelerating.

#### ACC functionality limited

The text message **ACC functionality limited** appears if the ACC system does not detect any objects for an extended period. The distance to vehicles in front is not being controlled while the message is displayed. The ACC system is not deactivated, and so extra care should be taken! The text message **ACC functionality limited** can appear for the following reasons:

- The ACC sensor is dirty. The ACC system is not responding or is not responding correctly to the vehicles in front!
- You may be driving on a country road with no traffic and *no clear roadside demarcation* (e.g. safety barriers, traffic signs, trees). As soon as the system detects a vehicle, distance control is resumed and the text message disappears. ►

The ACC sensor is located inside the trim grille (front right)  
 ⇒ *page 128*, fig. 136. If the sensor is no longer functioning due to dirt or obstruction in this area, it should be cleaned.

#### Parking brake !

The text message **Parking brake !** appears if the parking brake is operated. The adaptive cruise control will then be switched off. This is indicated by a warning tone.

#### Gear lever position !

On vehicles with manual gearbox the text message **Gear lever position !** appears when no valid forward gear is selected, i.e. reverse gear or 1st gear is engaged or the gear lever is in the neutral position. Adaptive cruise control is not available when the lever is in these positions.

#### Shift lever position!

On vehicles with automatic gearbox the text message **Shift lever position !** appears if the shift lever is moved to position **N**. Adaptive cruise control is not available when the lever is in this position. ■

Applies to vehicles: with adaptive cruise control

### Driver intervention prompt

*The driver intervention prompt is a warning for the driver to reduce speed manually.*

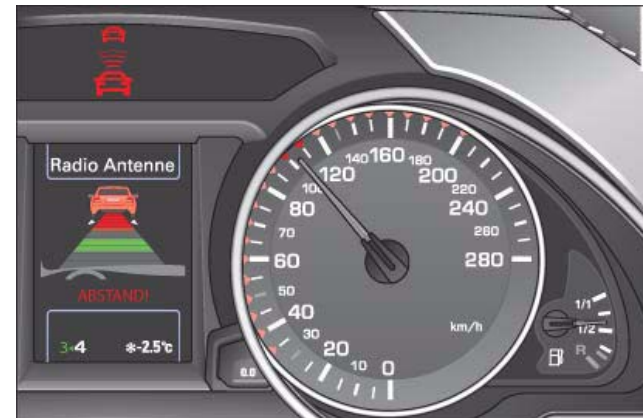

Fig. 147 Instrument cluster: Driver intervention prompt

In some situations the adaptive cruise control system alone is not able to brake the vehicle sufficiently to maintain a safe distance to the vehicle in front. The adaptive cruise control system will then call on you as the driver to take control of the situation **yourself**.

The **Driver intervention prompt** provides both a visual and an acoustic warning.

- A red vehicle symbol will appear in the instrument cluster display ⇒ fig. 147.
- The system status indicator will show **DISTANCE!**.
- The red warning lamp will start to flash. ▶

- An acoustic warning will also sound (unless it has been deactivated in the sound system or MMI\* settings).

### Note

- Pressing the brake pedal will switch off the adaptive cruise control system. The speed set at that point will, however, remain stored until the adaptive cruise control is activated again.
- To resume the programmed cruising speed, release the brake pedal and pull the control lever towards you ⇒ *page 132*, “Switching off the system (with speed memory function) and reactivating it”.
- If you exceed the target speed by pressing the accelerator, the **driver intervention prompt** will not be accompanied by a warning tone. The indicator lamp shown in the display will also switch off when the target speed is exceeded.
- If the adaptive cruise control triggers a braking operation the hydraulic brake system is under pressure. This is why brake pedal travel will be shorter and the pedal will feel “harder”. ■

Applies to vehicles: with adaptive cruise control

### Setting the warning tone volume and driving program

You can change the adaptive cruise control settings on the sound system or MMI\* to suit your individual driving style.



Fig. 148 Display: adaptive cruise control

- Select: Function selector button **CAR** > **adaptive cruise control**.

#### Setting the volume of the warning tone

If the adaptive cruise control system switches off (e.g. when the ESP intervenes) or a driver intervention prompt appears, a warning tone will sound.

You can set the volume of the warning tone to **low**, **medium**, or **high**. The new volume will sound briefly after making any adjustment. If you do not want a tone to sound, select **off**.

#### Adjusting the basic settings

You can set the distance (time interval) you want the adaptive cruise control system to keep to the vehicle in front by selecting **distance 1**, **distance 2**, **distance 3** or **distance 4**. ▶

### Setting the driving program

In the **Driving program** menu you can select either **dynamic**, **standard** or **comfort** according to your personal preferences.

#### Note

- We recommend you to leave the warning tone switched on. Even when the warning tone is switched off, not every warning tone will be deactivated.
- When you pass the key on to somebody else please remember to make the other driver aware of the ACC settings.
- We recommend a minimum distance setting of **DISTANCE 3** (factory default setting).
- When the ignition is switched off, the distance setting reverts to the factory default **DISTANCE 3**. A qualified workshop can cancel this function. In this case a default distance setting defined on the sound system or MMI\* is applied each time the engine is started. ■

## System limitations

Applies to vehicles: with adaptive cruise control

### General notes

*The following situations could impair the function of the radar sensor.*

The adaptive cruise control is subject to given physical limits and also has certain limits determined by the system itself. Under certain circumstances the driver may feel that the ACC system is responding unexpectedly or belatedly. For this reason, please always give your full attention to road traffic and if necessary take action yourself:

- When driving through bends ⇒ *page 140*.
- When vehicles in front are not in line with your vehicle ⇒ *page 141*.

- When other vehicles change lanes ⇒ *page 141*.
- When other vehicles are not clearly discernible ⇒ *page 141*
- When vehicles are stationary ⇒ *page 142*.

#### WARNING

**The radar sensor's "field of vision" can be impaired by rain, snow or a lot of water on the road. This results in vehicles in front not being properly recognised or, in some circumstances, not being detected at all. If necessary, take action yourself! ■**

Applies to vehicles: with adaptive cruise control

### When driving through bends

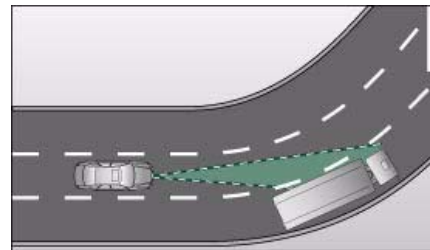

Fig. 149 Driving into a bend

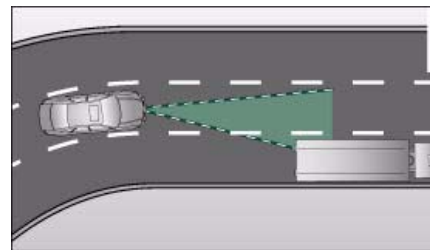

Fig. 150 Driving out of a bend

### Driving into a bend

When you are driving into a bend, the ACC system may react to a vehicle travelling in the other lane and therefore brake the vehicle ⇒ *page 140*, fig. 149. You can override the braking effect by pressing the accelerator.

### Driving out of a bend

When you are driving out of a long bend, the ACC system may - in the course of its calculation of the lane ahead - react to a vehicle travelling in the other lane and therefore brake the vehicle ⇒ *page 140*, fig. 150. You can override the braking effect by pressing the accelerator. ■

Applies to vehicles: with adaptive cruise control

### Vehicles in front travelling out of line

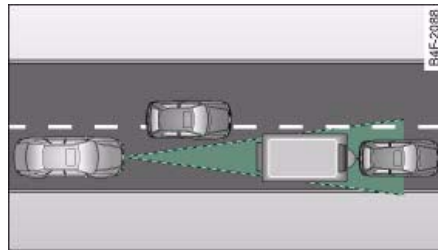

Fig. 151 The vehicle in front is outside the range of the radar sensor

Vehicles in front which are not in line with your vehicle cannot be detected by the ACC system until they are within the range of the sensor. ■

Applies to vehicles: with adaptive cruise control

### Other vehicles changing lanes

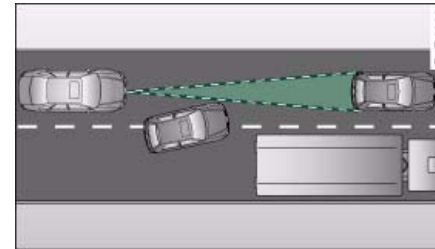

Fig. 152 A vehicle is changing lanes

Vehicles which are very close to you when they move onto your lane cannot be detected by the radar sensor until they move into its range. ■

Applies to vehicles: with adaptive cruise control

### Not clearly discernible vehicles

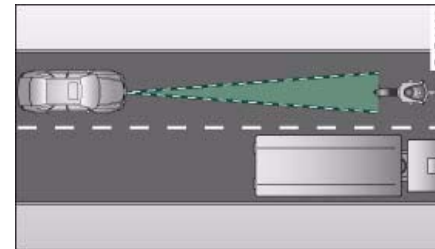
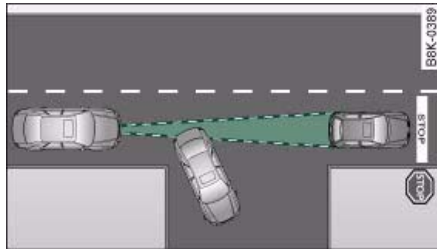

Fig. 153 Motorcycle in front

Vehicles that are not clearly discernible, e.g. a motorcycle travelling in front of you and vehicles with a large amount of ground clearance or protruding freight, are often identified late or may not be detected at all. ■

Applies to vehicles: with adaptive cruise control

**Stationary vehicles**

**Fig. 154** Vehicle turning off and vehicle stationary

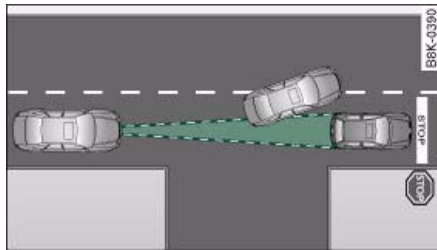

**Fig. 155** Vehicle changing lane and vehicle stationary

If a vehicle detected by the ACC system turns off or changes lane and another stationary vehicle is located in front of that vehicle, the ACC system will not react to the stationary vehicle ⇒ fig. 154 and ⇒ fig. 155. ■

**Audi braking guard**

Applies to vehicles: with adaptive cruise control

**Description**

*Audi braking guard warns you in case of an impending collision with a vehicle in front.*



**Fig. 156** Instrument cluster: Display

Audi braking guard is active at speeds above approximately 30 km/h and operates within the system limitations ⇒ page 140 even when the adaptive cruise control is deactivated.

The radar sensor is fitted at the front of the vehicle ⇒ page 130, fig. 137. The system requires reflecting surfaces in order to be able to measure the distance. If the ACC is unable to measure the distance it will not respond.

Once the system has measured the distance, it can assess a dangerous situation where a vehicle in front brakes suddenly or you are driving fast and approach a vehicle travelling at a much slower speed. The system warns you as soon as it anticipates that a potential collision with the vehicle in front can only be avoided by hard braking or by taking evasive action.

The system has a preset response time so that it can warn you in time. In certain situations, the system response time will be reduced dynamically, e.g. when you are accelerating onto a motorway. Braking, lateral acceleration and steering angle are other factors ►



which can shorten the system response time. The warning will be deactivated if you press the accelerator pedal right down in order to overtake.

The system draws the driver's attention to two different hazardous situations:

#### Distance !

A distance warning will be given if you travel too close to the vehicle in front for longer than 5 seconds. For example, if the distance is less than 9 m at 80 km/h, a message will appear in the instrument cluster display ⇒ *page 142, fig. 156.*

If the vehicle in front were to brake hard, a collision would no longer be avoidable, even if you reacted immediately. In this case, you should leave more room between your car and the vehicle in front.

#### Speed

If the vehicle in front of you is travelling in the same lane at a much slower speed or if it brakes hard, the Audi braking guard will calculate the time at which a collision can be avoided only by emergency braking or evasive action. When the system warns you, it is possible to avoid a potential collision with the vehicle in front by braking or changing lane. There are two warning levels:

- **Early warning:** A message will appear in the instrument cluster display and you will also hear a warning tone.
- **Acute warning:** The second (acute) warning will be triggered if you do not react to the advance warning. There will automatically be a short dab of the brakes to remind you to concentrate on the traffic.

If you brake hard, the brake assist system ⇒ *page 222* helps you to achieve the optimum braking effect.

#### WARNING

Please always direct your full attention to the road, even when the Audi braking guard is activated. It is always you who is responsible

#### WARNING (continued)

for determining your speed and for keeping a safe distance to the other vehicles on the road.

- Always maintain the statutory minimum safety distance to the vehicle in front (risk of accident).
- Due to the system limitations, the Audi braking guard will not react in certain situations, for example when approaching a stationary obstacle (such as the end of a traffic jam or a broken-down vehicle).
- Please note that the Audi braking guard is subject to limitations in tight bends on account of the radar sensor's field of vision. This means that obstacles may not be detected in certain situations.
- The radar sensor's "field of vision" can be impaired by rain, snow or a lot of water on the road. This results in vehicles not being reliably recognised or, in some circumstances, not being detected at all. Always keep the road ahead within your field of vision.
- Reflecting objects, such as crash barriers or the entrance to a tunnel, could impair the function of the radar sensor. ■

Applies to vehicles: with adaptive cruise control

### Status messages in the instrument cluster display

#### braking guard brake jolt

This driver message appears when the brakes are dabbled due to an acute warning.

#### braking guard off

This driver message appears when the system is switched off in the MMI. The message also appears briefly after you begin driving if the system is switched off. ►

The message will also appear if the system is unavailable due to an error or if you switch the ESP off ⇒ *page 222*. In this state, the system no longer warns you about an impending collision. ■

Applies to vehicles: with adaptive cruise control

### Settings for Audi braking guard

*The system and warning settings can be adjusted via the sound system or MMI\*.*



Fig. 157 Display: Audi braking guard

- Select: Function selector button **CAR** > **Audi braking guard**.
- **System** - The Audi braking guard system can be switched **on** and **off**.
- **Early warning** - The acoustic signals and display messages can be switched **on** and **off**.

#### Note

The settings are stored on the remote control key in use. When you pass the key on to somebody else please remember to make the other driver aware of the Audi braking guard settings ⇒ *page 43*. ■

## Audi lane assist

### Audi lane assist

Applies to vehicles: with lane assist

#### Description

*The lane assist system assists the driver in keeping the vehicle in the right lane.*

The system uses a camera to detect the markings of the lane you are driving in. If the vehicle approaches one of the detected lane markings, the steering wheel *vibrates* to warn the driver that the vehicle might be about to cross one of the markings. The lane assist system is functional when it has detected lane markings on both sides of the lane you are driving in. The green lamp  in the instrument cluster indicates that the function is activated and fully functional.

If you operate the turn signal before crossing one of the lane markings (while the lane assist system is functional), the system will detect that the lane change is intended and will not warn the driver.

As the system is designed for driving on motorways and other major roads, it is only active above a speed of about 65 km/h.

#### WARNING

- The lane assist system does not keep the vehicle in its lane. It merely warns the driver when the vehicle is in danger of crossing the markings of the lane. As the driver you are always responsible for staying in your own lane.
- The camera cannot detect all lane markings. Therefore it is possible that variations in the road surface or objects might be detected as lane markings, which can lead to false warnings, or warnings not being given.
- The camera's view might be obstructed, for example by vehicles travelling in front, rain, snow, a lot of water on the road or

#### WARNING (continued)

**adverse light. This can result in the system not detecting the lane markings correctly. ■**

Applies to vehicles: with lane assist

#### Switching on and off

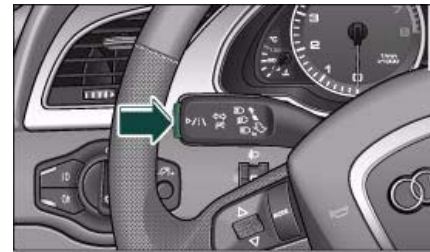

Fig. 158 Turn signal lever: Pushbutton for Audi lane assist

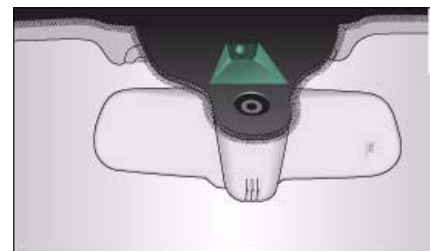





Fig. 159 Windscreen: Camera window for Audi lane assist

- Press the button  fig. 158 -arrow- to switch the system on and off. The indicator lamp  in the instrument cluster will light up or go out. 

**Indicator lamp in instrument cluster**

**/!\ Active:** The green indicator lamp confirms that the system is fully functional. You will be warned if you are about to cross the lane markings detected by the system.

**/!\ Inactive:** The yellow warning lamp indicates that the system is switched on. However, you will not be warned if you cross the lane markings. This can have the following causes:

- There is only one or no lane marking.
- The system cannot detect the lane markings (e.g. due to snow, dirt, wet conditions or adverse light).
- There are more than two lane markings in the lane you are driving in (e.g. in roadwork sections).
- The vehicle's speed is below 65 km/h, the speed at which the lane assist system is activated.
- The lane is narrower than 2.5 m or wider than 5 m.
- The bend is too tight.

**Note**

- Make sure that the camera window ⇒ *page 145*, fig. 159 is not covered with stickers or similar objects.
- Always keep the camera window clean. Usually it should suffice to operate the windscreen wipers. ■

Applies to vehicles: with lane assist and on-board computer

**Instrument cluster display**

**Fig. 160 Instrument cluster: lane assist switched on and in warning mode**

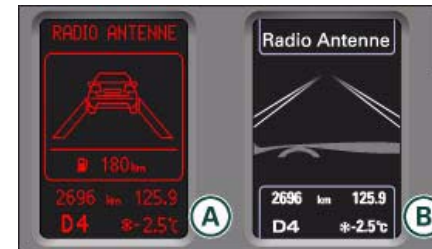

**Fig. 161 Instrument cluster: lane assist switched on but not ready for warning**

You can call up the display for the lane assist by repeatedly pressing the **(RESET)** button on the windscreen wiper lever. For more details refer to ⇒ *page 27*.

When the lane assist is switched on, two lines indicate the lane demarcations on the left and right of your vehicle.

**Version **A**: Monochrome display**

- Solid red lines: The lane assist is switched on and ready to warn.
- One red line flashing (left or right): The lane assist warns you before you cross the lane demarcation ⇒ fig. 160, A ▶

- Unfilled lines: The lane assist is switched on but not ready for warning ⇒ *page 146*, fig. 161, **A**

#### Version **B**: High-resolution display

- Solid white lines: The lane assist is switched on and ready to warn.
- Solid red line (left or right): The lane assist warns you before you cross the lane demarcation ⇒ *page 146*, fig. 160.
- Unfilled lines: The lane assist is switched on but not ready for warning ⇒ *page 146*, fig. 161.

#### Messages in the instrument cluster display

Should the lane assist be deactivated automatically, the indicator lamp in the instrument cluster will go out and one of the following messages will appear in the instrument cluster display:

##### Audi lane assist not available: currently no sensor vision

This message is displayed when the camera is no longer functional after the system has continuously failed to detect the lane markings. This can have the following causes:

- The outside of the camera window ⇒ *page 145*, fig. 159 is dirty or frosted. Please remove dirt or ice from this area of the wind-screen.
- The inside of the camera window is misted up. In this case, please wait for the camera window to demist before switching on the lane assist system again.
- Due to the conditions (e.g. snow-covered road) the system has not been able to detect the lane markings for a long period. Do not switch the lane assist system on again before the lane markings are discernible.

##### Audi lane assist currently not available

A temporary error is preventing the lane assist system from fully functioning. Try switching on the lane assist system again later.

##### Audi lane assist: system fault

The system should be checked by an Audi dealership or other qualified workshop. ■

Applies to vehicles: with lane assist

### Setting the warning time and steering vibration

You can change the lane assist settings on the sound system or MMI\* to suit your individual preferences.



Fig. 162 Display: Setting time of warning and steering vibration

- Select: Function selector button **CAR** > **Audi lane assist**.

#### Setting time of warning

**early:** In this setting, the driver will be warned before a wheel crosses a lane marking. The warning depends on the angle with which the vehicle is approaching the lane marking. The larger the angle with which you are driving towards the marking, the earlier you will receive the warning, i.e. the distance between the vehicle and the marking might still be still relatively long. If you are driving toward the marking at a very narrow angle, you will receive the warning later, i.e. shortly before one of the wheels touches the marking.

**adaptive:** In this setting, the time of warning is adapted to the road layout and the vehicle's speed. The warning will be received later when you are driving through a bend, and earlier when you are

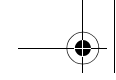

driving on a straight section. On narrow roads, the system will give off warnings later than on wide roads.

**late:** In this setting, the driver will be warned when a wheel crosses a lane marking.

#### Setting steering wheel vibration

You can set the steering vibration to **low**, **medium** or **strong**. The steering wheel will vibrate so that you can check your selection.



#### Note

- The lane assist is not active while you are changing the setting; the brief vibration of the steering wheel is only intended to help you make the desired setting.
- Your personal settings are stored automatically and assigned to the remote control key which is being used. ■

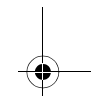
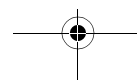
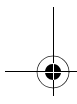
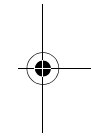
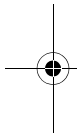

## Audi side assist

### Lane change assist feature

Applies to vehicles: with side assist

#### Description

*The side assist function assists the driver when changing lanes.*



Fig. 163 Rear bumper: Position of radar sensors (not externally visible)

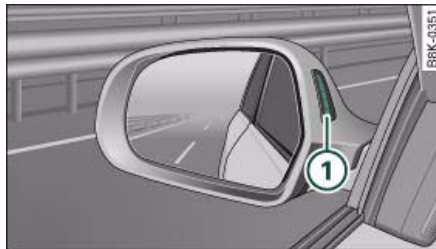

Fig. 164 Warning lamp on exterior mirror (driver's side)

The side assist function employs radar sensors ⇒ fig. 163 to assist the driver in monitoring following traffic and the blind spots on both sides of the car ⇒ page 151, fig. 166.

Warning lamps are incorporated in the two exterior mirrors ⇒ fig. 164. The warning lamp on the left-hand mirror assists the driver when changing lane towards the left and the warning lamp on the right-hand mirror assists the driver when changing lane towards the right.

When one of these lamps lights up, this is to inform you that the side assist has detected a vehicle on that side and calculates that a lane change would be critical. This is the first stage of the warning, referred to as the **information mode** ⇒ page 151. This stage of the warning is designed to be visible only when you look in the exterior mirror.

If you operate the turn signal when the side assist has registered what it judges to be a critical vehicle, the lamp on the exterior mirror will then flash several times with greater intensity. This is the **warning mode** ⇒ page 151. ■

Applies to vehicles: with side assist

#### Switching on and off

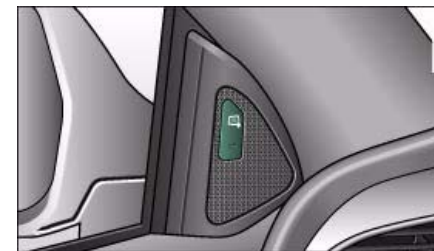

Fig. 165 Driver's door: Button for side assist ►

### Switching on

- Press the button ⇒ *page 149*, fig. 165. The red indicator lamp in the button will light up.

### Switching off

- Press the button again. The indicator lamp in the button will go out.

The system is designed to provide assistance on motorways and other out-of-town roads, so it only operates at speeds above about 60 km/h.

#### WARNING

- Please note that the sensors are not always able to detect all vehicles which may represent a potential hazard (accident risk).
- Please note that the side assist is not able to give adequate warning of vehicles approaching very fast from behind, or vehicles that you are overtaking rapidly.
- The radar sensor's "field of vision" can be impaired by rain, snow or a lot of water on the road. This results in vehicles not being reliably recognised or, in some circumstances, not being detected at all by the side assist. Always give your full attention to the position of your vehicle on the road and other nearby traffic.
- The side assist only gives a warning of approaching vehicles and vehicles in the blind spots when road speed is above 60 km/h.
- Please note that the side assist does not operate in tight bends (with a radius of less than 200 metres).
- The side assist feature is not a substitute for the full concentration of the driver. The driver is always responsible for the safety of lane changes and other manoeuvres. Always give your full attention to the position of your vehicle on the road and other nearby traffic.

#### Caution

- To avoid impairing the function of the side assist, do not attach any objects (e.g. stickers or bicycle carriers) in such a way that they might interfere with the radar sensors in the rear bumper.
- Make sure that the warning lamps on the exterior mirrors are not obscured by stickers or other objects.

#### Note

- To ensure that the side assist function works properly, do not allow snow and ice to accumulate on the rear bumper near the radar sensors. Please observe the additional notes on ⇒ *page 157*.
- The side assist function will be switched off automatically when the electrical connector for the trailer socket is plugged in on vehicles with a factory-fitted towing bracket.
- The side assist should be switched off manually when towing a trailer if the vehicle is equipped with a towing bracket which was not factory-fitted.
- The side assist system will switch off automatically if it detects an obstruction that impairs the function of the radar sensors.
- The warning lamps on the exterior mirrors may not be properly visible if tinted foil is affixed to the side windows on the driver's or passenger's side. ■



Applies to vehicles: with side assist

### Area covered by the radar sensors

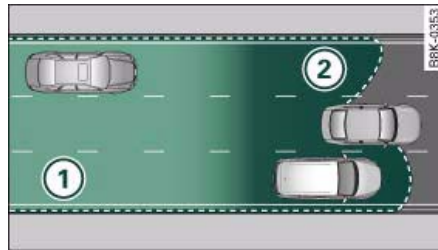

Fig. 166 Schematic diagram: Area covered by the radar sensors

The area covered by the radar sensors ⇒ fig. 166 consists of:

- The rearward approach zone (light green area: up to about 50 metres) ① and
- Blind spots (dark green area) ②.

The radar sensors monitor the lanes immediately to the left and right of your vehicle. Other lanes are *not* covered by the sensors.

#### Note

The side assist system is programmed for lanes of a fixed width, and is not able to measure differing lane widths. It monitors a zone equivalent to one normal lane width on either side. If the lanes are narrower than this, or if vehicles are not travelling in the centre of the lanes, the system may register vehicles that are *not* in fact travelling in an adjacent lane ⇒ *page 156*. ■

Applies to vehicles: with side assist

### How the system works

When other vehicles are detected, the side assist system registers their distance and how fast they are approaching. The warning lamp

on the relevant exterior mirror will light up whenever the side assist calculates that the distance and the speed differential of approaching vehicles would be critical in the event of a lane change.

The warning lamp may light up when you are being overtaken and when you are overtaking another vehicle.

If you are overtaking slowly, with a speed differential of less than 15 km/h, the warning lamp will light up as soon as the other vehicle enters your blind spot and is detected by the sensors. If you are overtaking with a speed differential which is greater than this the lamp will not give a warning. ■

Applies to vehicles: with side assist

### Information mode and warning mode

The side assist has two modes of operation

- The information mode and
- The warning mode

The side assist will respond in the appropriate mode, depending on whether or not you operate the turn signal to indicate an intended lane change.

#### Information mode

As long as you do not operate the turn signal, the side assist will merely inform you of the presence of vehicles that it has detected and judges to be critical in the event of a lane change. The warning lamp on the relevant exterior mirror will light up with low intensity whenever the side assist calculates that the distance and the speed differential of an approaching vehicle are critical.

The intensity of the warning lamp in this information mode is deliberately kept relatively low, so that it does not distract you while you are looking at the road in front and do not intend to change to a different lane. The information mode is clearly visible when you look in the exterior mirror. ►

**Warning mode**

If you operate the turn signal when the side assist has detected a vehicle on that side that it judges to be critical in the event of a lane change, the warning lamp on the relevant exterior mirror will flash brightly several times. This is the warning mode: if the lamp flashes brightly it warns you that you should check the situation again in the mirror and by looking back over your shoulder ⇒ ⚠ in "Safety notes" on *page 157*.

**i Note**

You can adjust the brightness of the warning lamps on the exterior mirrors via the MMI ⇒ *page 155*. ■

Applies to vehicles: with side assist

**Situation with vehicle approaching rapidly from behind**

Fig. 167 side assist: Vehicles approaching rapidly from behind

**① Warning lamp on exterior mirror does not light up**

The sensors have not detected any vehicles. The warning lamp on the exterior mirror does not light up ⇒ ⚠ in "Safety notes" on *page 157*.

**② Warning lamp lights up in information mode**

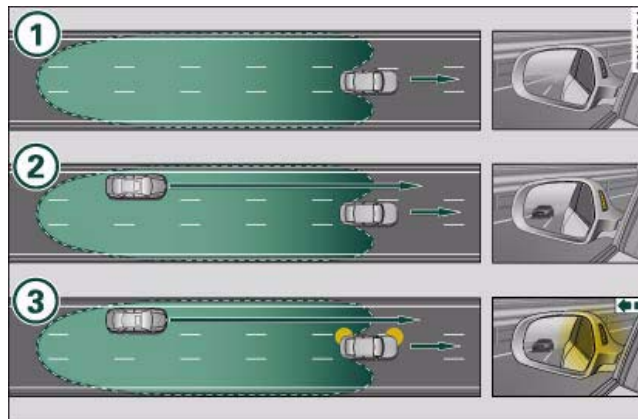
The sensors have detected a rapidly approaching vehicle - in this example in the left-hand lane. Because of its approach speed, this vehicle is already judged to be critical in the event of a lane change even though it is still some distance away. The warning lamp on the exterior mirror lights up in the information mode ⇒ *page 151*.

**③ Warning lamp flashes in warning mode**

If you operate the turn signal in situation ②, the warning lamp on the exterior mirror will flash briefly several times. This calls your attention to the presence of a vehicle which you may have overlooked.

**i Note**

- The faster a vehicle approaches, the earlier the warning will appear on the exterior mirror. In all cases, the side assist will give a warning for the vehicles it has detected at the latest when they enter the "blind spot".
- If a vehicle is approaching at high speed it is possible that a lane change may be critical, even though no warning is given. ■

Applies to vehicles: with side assist

### Situation with vehicle approaching slowly from behind

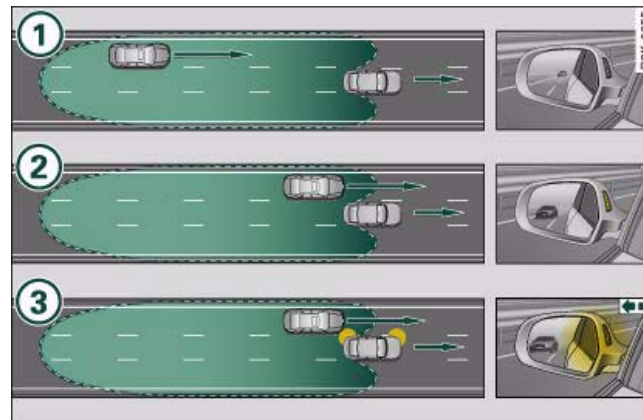

Fig. 168 side assist: Vehicles approaching slowly from behind and vehicles in the blind spot

#### ① Warning lamp on exterior mirror does not light up

The sensors have detected a slowly approaching vehicle - in this example in the left-hand lane. Because it is relatively far away and only approaching slowly, no warning will appear on the exterior mirror ⇒ ⚠ in "Safety notes" on page 157.

#### ② Warning lamp lights up in information mode

The slowly approaching vehicle is now closer. The warning lamp on the exterior mirror lights up in the information mode.

The warning lamp on the exterior mirror will only light up if the side assist calculates that the distance and the speed differential of approaching vehicles would be critical in the event of a lane change.

In all cases, the side assist will light up to indicate the vehicles it has detected at the latest when they enter the "blind spot".

#### ③ Warning lamp flashes in warning mode

If you operate the turn signal in situation ②, the warning lamp on the exterior mirror will flash briefly several times. This calls your attention to the presence of a vehicle which you may have overlooked.

#### **i** Note

- The faster a vehicle approaches, the earlier the warning will appear on the exterior mirror. The side assist will give a warning for the approaching vehicles it has detected at the latest when they enter the "blind spot".
- If a vehicle is approaching at high speed it is possible that a lane change may be critical, even though no warning is given. ■

Applies to vehicles: with side assist

### Situation when you are slowly overtaking other vehicles

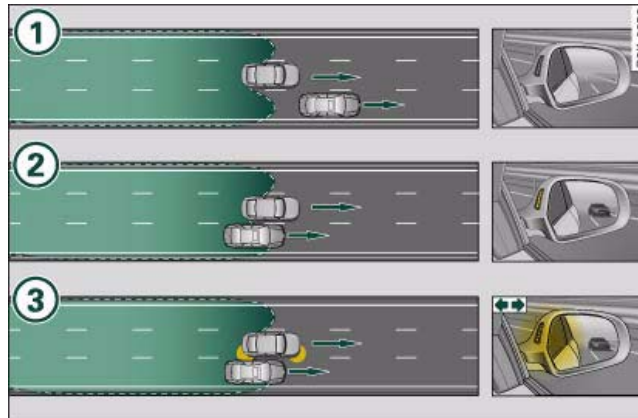

Fig. 169 side assist: Other vehicles being overtaken slowly

- ① **Warning lamp on exterior mirror does not light up**  
The vehicle you are overtaking has not yet been detected by the side assist. The warning lamp on the exterior mirror does not light up ⇒ ⚠ in "Safety notes" on page 157.
- ② **Warning lamp lights up in information mode**  
The vehicle you are passing slowly (with a speed differential less than 15 km/h) is detected by the side assist. The warning lamp on the exterior mirror lights up in the information mode.
- ③ **Warning lamp flashes in warning mode**  
If you operate the turn signal in situation ②, the warning lamp on the exterior mirror will flash briefly several times. This calls your

attention to the presence of a vehicle which you may have overlooked. ■

Applies to vehicles: with side assist

### Situation when you are rapidly overtaking other vehicles

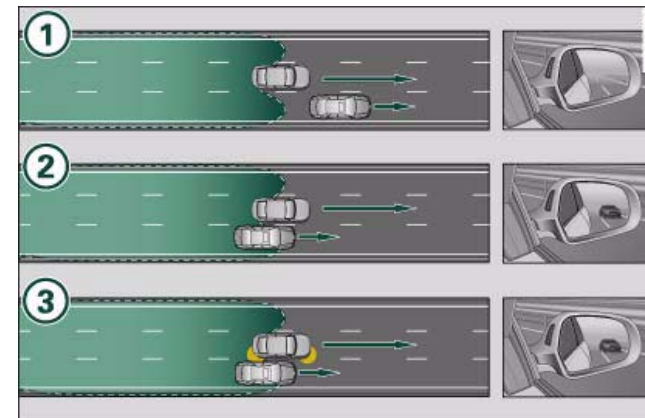

Fig. 170 side assist: Other vehicles being overtaken rapidly

- ① **Warning lamp on exterior mirror does not light up**  
The vehicle you are overtaking has not yet been detected by the side assist. The warning lamp on the exterior mirror does not light up ⇒ ⚠ in "Safety notes" on page 157.
- ② **Warning lamp lights up in information mode**  
The vehicle you are passing rapidly (with a speed differential greater than 15 km/h) is detected by the side assist but is not judged to be critical in the event of a lane change since it is dropping back ▶

quickly. The warning lamp on the exterior mirror does not light up ⇒ ⚠ in "Safety notes" on page 157.

### ③ Warning lamp on exterior mirror does not light up

If you operate the turn signal in situation ②, the warning lamp on the exterior mirror will still not give any warning ⇒ ⚠ in "Safety notes" on page 157. ■

Applies to vehicles: with side assist

## Adjusting brightness of warning lamp on exterior mirror

You can adjust the brightness of the warning lamp on the sound system or MMI\*.



Fig. 171 Display: Adjusting brightness of warning lamp

- Select: Function selector button **CAR** > **Audi side assist** > **Warning lamp: brightness**.

The brightness of the warning lamp in both the information and warning modes is regulated automatically according to the ambient light level. You can also adjust the basic *brightness level* of the warning lamp yourself via the function **Warning lamp: brightness**.

The new brightness level will be displayed briefly while you are making the adjustment. The brightness level that is shown at this point is the intensity of the lamp when it comes on in the informa-

tion mode. The intensity of the lamp in the warning mode is linked to the intensity in the information mode.

The brightness of the lamp in the information mode should be set so that you can see the lamp when you glance at the exterior mirror, but are not aware of it when looking forwards through the wind-screen.

If you are in very dark or very light surroundings when you adjust the brightness of the warning lamp, the automatic brightness control may already have reached the lowest or the brightest setting. Under these circumstances the brightness of the warning lamp on the exterior mirror may not change visibly when you alter the basic *brightness level*.

If you adjust the basic *brightness level* while the vehicle is in in very dark or very light surroundings, the change in the setting may only become visible in surroundings of more moderate brightness.

### **i** Note

- The side assist is not active while you are changing the brightness setting; the brief flash of the warning lamp is only intended to help you make the desired setting.
- Your personal settings are stored automatically and assigned to the remote control key which is being used. ■

Applies to vehicles: with side assist

## General notes

The side assist system has inherent limitations in some situations. For this reason, please take particular care:

- When driving through bends ⇒ page 156
- On roads with varying lane widths ⇒ page 156. ■

Applies to vehicles: with side assist

### When driving through bends

The side assist cannot detect vehicles in tight bends (with a radius of less than 200 metres).

When driving through a bend, the side assist may react to a vehicle that is two lanes away and activate the warning lamp in the exterior mirror. ■

Applies to vehicles: with side assist

### Lane widths

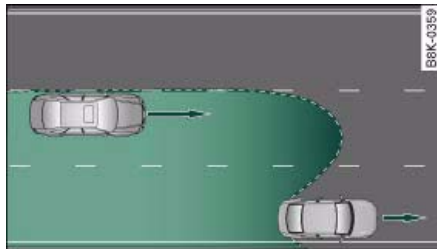

Fig. 172 Lanes of normal width are covered by the sensors

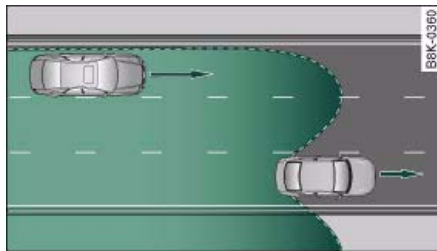

Fig. 173 Narrow lanes: side assist may react to vehicles travelling two lanes away

The side assist system is designed to cover adjacent lanes of normal width on both sides of your vehicle (left and right), regardless of

whether you are driving directly in the centre of your lane or further to one side.

If the lane widths are reduced, the sensors may also detect vehicles in additional lanes, especially if you are driving further to one side of your lane ⇒ fig. 173. In such situations the system may react to vehicles travelling two lanes away, so that the side assist activates the information or the warning mode.

Similarly, if the lanes are very wide, it is possible that the system may not detect vehicles in the adjacent lane because they are outside the area covered by the sensors. ■

### Notes

Applies to vehicles: with side assist

### Messages in the instrument cluster display

Should the side assist be deactivated automatically, the indicator lamp in the button will go out and a message will appear in the instrument cluster display:

#### Audi side assist not available: sensors blocked

The sensors, which are not externally visible, are incorporated on either side of the rear bumper ⇒ page 149, fig. 163. To ensure the proper function of the side assist system, do not attach any objects (such as stickers or bicycle carriers, etc.) to the rear bumper in such a way that they might obstruct these sensors. Should the function of the system be impaired, the instrument cluster display will show this message. Please check whether anything is obstructing the sensors and remove the obstruction if necessary.

#### Audi side assist currently not available

The side assist is temporarily inoperative and cannot be switched on (for instance if the battery is not sufficiently charged). ►

**Audi side assist: system fault**

The system should be checked by an Audi dealership or other qualified workshop.

**Audi side assist not available when towing**

On vehicles with a factory-fitted towing bracket the side assist function will be switched off automatically when the electrical connector for the trailer is plugged in, and this message will appear in the instrument cluster display. The side assist function may not be switched off automatically if the towing bracket is not of the factory-fitted type. ■

Applies to vehicles: with side assist

**Safety notes**

The function of the side assist can be restricted when driving in tight bends or over crests and in bad weather conditions.

It is possible that the radar sensors may register objects such as high or offset roadside barriers as well as other vehicles.

The side assist system is programmed for lanes of a fixed width, and is not able to measure differing lane widths. It monitors a zone equivalent to one normal lane width on either side. If the lanes are narrower than this, or if vehicles are not travelling in the centre of the lanes, the system may give a warning for vehicles which it judges to be critical, even though they are *not* in fact travelling in an adjacent lane.

**! WARNING**

- Please note that the sensors are not always able to detect all vehicles which may represent a potential hazard (accident risk).
- Please note that the side assist is not able to give adequate warning of vehicles approaching very fast from behind, or vehicles that you are overtaking rapidly.

**! WARNING (continued)**

- The radar sensor's "*field of vision*" can be impaired by rain, snow or a lot of water on the road. This results in vehicles not being reliably recognised or, in some circumstances, not being detected at all by the side assist. Always give your full attention to the position of your vehicle on the road and other nearby traffic.
- The side assist only gives a warning of approaching vehicles and vehicles in the blind spots when road speed is above 60 km/h.
- Please note that the side assist does not operate in tight bends (with a radius of less than 200 metres).
- The side assist feature is not a substitute for the full concentration of the driver. The driver is always responsible for the safety of lane changes and other manoeuvres. Always give your full attention to the position of your vehicle on the road and other nearby traffic.

**! Caution**

To avoid impairing the function of the side assist, do not attach any objects (e.g. stickers or bicycle carriers) in such a way that they might interfere with the radar sensors in the rear bumper.

**i Note**

For reasons of safety, the side assist system must be checked by a qualified workshop if the positions of the radar sensors have been affected by a rear-end collision, etc. ■

Applies to vehicles: with side assist

**Conformity certification**

The side assist employs radar sensors operating in one of two frequency bands at 24 GHz. Please note that in some countries only one of these two frequency bands is permitted. Accordingly, the frequency band permitted in the country where the vehicle is being ►

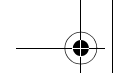

operated must be set by a qualified workshop, or if necessary the side assist must be deactivated.

The manufacturer certifies that, when used in the authorised manner, the side assist conforms with the requirements of §3 and the other relevant provisions of the "1999/5/EC Guideline issued by the European Parliament and the European Council".

The side assist is certified for use in the following countries:

Austria, Belgium, Cyprus, Czech Republic, Denmark, Estonia, Finland, GB/Northern Ireland, Germany, Greece, Hungary, Iceland, Ireland, Italy, (San Marino, Vatican City), Latvia, Lithuania, Luxembourg, Malta, Netherlands, Norway, Poland, Portugal, Slovakia, Slovenia, Spain (Andorra, Balearic Islands, Canary Islands), Sweden, Switzerland. ■

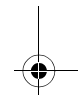
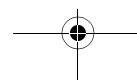
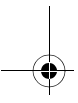
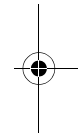
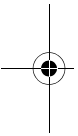



## Audi drive select

### Adjusting the vehicle set-up

Applies to vehicles: with Audi drive select

#### Introduction

Audi drive select allows you to use different set-ups on your vehicle. Using the three modes COMFORT, AUTO and DYNAMIC, you can change the set-up at the press of a button for a more comfort-oriented or dynamic drive.

On vehicles with MMI\*, you also have the INDIVIDUAL\* mode, which allows you to adapt the vehicle set-up individually to your personal driving style. For example, you might choose to combine a more dynamic engine set-up with a lighter steering response. ■

Applies to vehicles: with Audi drive select

#### Description

The possible vehicle set-up in each mode depends on which equipment is installed on your vehicle. The engine and the servotronic power steering are basic parts of your vehicle which are always included in the set-up. In addition, you can change the characteristics of the automatic gearbox\*, dynamic steering\* and suspension control\*.

The response of the **engine** and **automatic gearbox\*** to accelerator pedal movements will be more spontaneous or balanced, depending on which mode you select.

The **servotronic power steering** ⇒ page 225 will also respond to different drive set-ups.

The **dynamic steering\*** alters the steering ratio depending on the road speed to optimise the amount of steering effort required by the driver at any given time. This enables the sensitivity of the steering

to be reduced at higher speeds in order to improve the handling of the vehicle. The steering is more direct at lower speeds to minimise the amount of steering effort required by the driver, e.g. when manoeuvring in tight spaces. The dynamic steering\* also provides a more agile steering response at low and medium speeds. You can adjust the basic characteristics of the steering in the Audi drive select menu.

The **suspension control\*** uses sensors to collect information on steering movements, braking and acceleration input by the driver, road surface quality, road speed and vehicle loading. Using this information, the suspension can be adapted almost instantaneously to changing driving conditions. With Audi drive select, the driver can choose between dynamic and comfort-oriented suspension set-ups (DYNAMIC and COMFORT modes), or opt for a more balanced set-up (AUTO mode).

The following table provides an overview of the characteristics in each driving mode.

Systems	COMFORT	AUTO	DYNAMIC
Engine or engine/gearbox*	Balanced	Balanced	Dynamic
Steering	Comfortable	Balanced	Dynamic
Dynamic steering*	Comfortable (indirect)	Balanced (direct)	Dynamic (direct)
Suspension control*	Comfortable	Balanced	Dynamic

If your vehicle is equipped with dynamic steering\*, the servotronic power steering settings are adjusted in the **Dynamic steering\*** menu. ►

**Note**

- You can select the sport program for gear changes on vehicles with an automatic gearbox\* by activating the **DYNAMIC** mode. There is no S position on the selector lever.
- You may hear a noise on vehicles with dynamic steering\* when you start or stop the engine. This is no cause for concern. ■

Applies to vehicles: with Audi drive select

**Selecting the driving mode**

You can choose between **COMFORT**, **AUTO**, **DYNAMIC** and **INDIVIDUAL\***.



Fig. 174 Selector gate: Control for Audi drive select



Fig. 175 Centre console: Control for Audi drive select

The control is next to the selector gate ⇒ fig. 174 on vehicles with sound system, or in the centre console ⇒ fig. 175 on vehicles with MMI\*.

- Switch on the ignition.
- Press the left or right arrow button until the desired mode lights up in red.

You can change the driving mode while the vehicle is stationary or moving. If traffic conditions permit, take your foot off the accelerator briefly after you change the mode so that the new mode is also activated for the engine.

**COMFORT**

The **COMFORT** mode alters the vehicle set-up for a more comfortable ride. The response of the engine and automatic gearbox\* to accelerator pedal movements is balanced. The steering is light and indirect\* and the suspension control\* is set to soft. This setting is suitable for driving long distances on motorways for example.

**AUTO**

The overall impression in **AUTO** mode is of a comfortable but dynamic ride. This setting is suitable for everyday use.

**DYNAMIC**

**DYNAMIC** gives the vehicle a tighter set-up. The engine reacts spontaneously to accelerator pedal movements and the steering is dynamic and direct\*. The suspension control\* is stiffer and the automatic gearbox\* changes gear at higher engine speeds. This setting is ideal for performance driving.

**INDIVIDUAL\***

You can configure this mode on the MMI according to your personal preferences. ►

 **WARNING**

**Always keep an eye on the traffic when using the Audi drive select controls - Risk of accident!**

 **Note**

If you remove the ignition key, the AUTO mode will be selected automatically the next time you switch on the ignition. ■

Applies to vehicles: with MMI and Audi drive select

### Settings for INDIVIDUAL driving mode

*You can configure your own personal vehicle set-up on the MMI\*.*



Fig. 176 MMI display: Changing the set-up individually

- Select: Function selector button **CAR** > **Audi drive select individual**.

To drive with the new vehicle set-up, remember to press the INDIVIDUAL\* button ⇒ *page 160*.

The system settings available on the MMI\* depend on which equipment is installed on your vehicle.

## Automatic gearbox

### multitronic<sup>®</sup>, tiptronic (6-speed gearbox)

Applies to vehicles: with multitronic<sup>®</sup> or tiptronic

#### Introduction

##### Applies to vehicles with multitronic<sup>®</sup> gearbox

The vehicle is equipped with an electronically controlled **continuously variable transmission** (multitronic<sup>®</sup>). Unlike conventional automatics, the gear ratios are not shifted in fixed steps but continuously variable. This gives smoother transmission and makes for better fuel economy.

The gearbox selects the gear ratio and shifts up or down automatically according to the gear change programmes stored in the control unit ⇒ *page 166*.

If desired, you can also select the gears *manually* (**tiptronic mode**) ⇒ *page 166*.

Please note that on vehicles with a multitronic<sup>®</sup> gearbox, torque is transmitted via a multi-plate clutch, and not via a torque converter as on conventional automatics. This means that the car will not "creep" as much as conventional automatics when the engine is idling if you stop temporarily with the selector lever in position D, S or R.

##### Applies to vehicles with tiptronic gearbox

The vehicle is equipped with an electronically controlled 6-speed automatic gearbox. The gearbox changes up and down *automatically*.

If desired, you can also select the gears *manually* (**tiptronic mode**) ⇒ *page 166*. ■

Applies to vehicles: with multitronic<sup>®</sup> or tiptronic

#### General notes on using multitronic<sup>®</sup>

*The gears are changed automatically.*



Fig. 177 Detail of the centre console: Selector lever with interlock button

#### Driving away from a standstill

- Press and hold the brake pedal.
- Press and hold the interlock button (the button in the selector lever handle), move the selector lever to the desired position, for instance D, and release the interlock button.
- Wait for the gearbox to engage the gear (a slight movement can be felt).
- Release the brake and press the accelerator ⇒ ⚠.

#### Stopping briefly

- Apply the foot brake to hold the vehicle when stationary (for instance at traffic lights). ▶

- To prevent the vehicle from rolling away, apply the parking brake before moving off on steep gradients ⇒ .
- As soon as you accelerate as normal, the parking brake will automatically be released and the vehicle will start moving.

### Parking the car

- Press and hold the brake pedal ⇒ .
- Apply the parking brake.
- Press and hold the interlock button, move the selector lever to P and release the interlock button.

The engine can only be **started** when the selector lever is at P or N.

On level ground it is sufficient to move the selector lever to P. On a gradient the parking brake should be applied first and the selector lever should be moved to P. This reduces the load on the locking mechanism and makes it easier to move the selector lever out of position P.

Vehicles with multitronic® gearbox: Your vehicle is equipped with the **hill hold assist function** which makes it easier to drive away on a slope. The system is activated when you press and hold the brake pedal for **a few seconds**. When you release the brake pedal the braking force will be maintained for a *moment* in order to prevent the vehicle rolling back when you drive away.

### WARNING

- Do not press the accelerator while selecting a gear with the vehicle stationary and the engine running, as this could cause an accident.
- Please note that some power will still be transmitted when you stop temporarily with the selector lever in position D, S or R. For

### WARNING (continued)

this reason, to avoid risking an accident, apply the footbrake firmly when stopping to prevent the vehicle rolling away.

- Never move the selector lever to R or P when driving, as this could cause an accident.
- Vehicles with multitronic® gearbox: Please note that some power will still be transmitted when you stop temporarily with the selector lever in position D, S or R. For this reason, to avoid risking an accident, apply the footbrake firmly when stopping to prevent the vehicle rolling away. ■

Applies to vehicles: with multitronic® or tiptronic

### Selector lever positions

This section covers all the selector lever positions.



Fig. 178 Display: Selector lever positions

The current selector lever position is shown in the instrument cluster display.

### P - Parking lock

This locks the driving wheels mechanically. The parking lock must only be engaged when the vehicle is *stationary* ⇒ .

The interlock button (the button in the selector lever handle) must be pressed in *and* the brake pedal must be depressed before

moving the selector lever either in or out of position P. The lever can only be moved out of position P when the ignition is on.

#### R - Reverse gear

When reverse gear is engaged the gearbox automatically selects the **lowest gear ratio**.

Reverse gear must only be engaged when the vehicle is *stationary* and the engine is idling ⇒ ⚠.

To move the selector lever to position R, press in the interlock button *and* at the same time press the brake pedal. Depending on the model, one or two reversing lights will come on in selector lever position R (when ignition is switched on).

#### N - Neutral

In this position the gearbox is in neutral ⇒ ⚠.

#### D - Drive (forwards)

In this position the gearbox automatically selects the best gear ratio. This depends on the engine load, the road speed and the dynamic gear control program (DCP).

Press the brake pedal when moving the selector lever from N to D if the vehicle is stationary or at speeds below 5 km/h ⇒ ⚠.

In some situations (such as on mountain roads or when towing a trailer or caravan) it can be advantageous to switch temporarily to tiptronic mode ⇒ *page 166*, so that the gear ratios can be selected *manually* to suit the driving conditions.

#### S - Sport position

Select this position if you wish to take full advantage of the car's performance. This setting makes use of the engine's maximum power output. When accelerating the gear shifts will be noticeable.

Press the brake pedal when moving the selector lever from N to S if the vehicle is stationary or at speeds below 5 km/h ⇒ ⚠.

#### ⚠ WARNING

- Never move the selector lever to R or P when driving, as this could cause an accident.
- In selector position D or S the vehicle must always be held with the foot brake when the engine is running. This is because an automatic gearbox still transmits power even at idling speed, and the vehicle tends to "creep". The throttle must on no account be opened inadvertently (for instance by hand from the engine compartment) when a gear is engaged with the vehicle stationary. The vehicle could otherwise start moving immediately (in some cases even if the parking brake is engaged) and possibly cause an accident.
- To avoid accidents, apply the parking brake and put the selector lever in position P before opening the bonnet and working on the vehicle with the engine running. Please observe the important safety warnings ⇒ *page 255*, "Working on components in the engine compartment".

#### i Note

You can select the sport program for gear changes on vehicles with Audi drive select\* by activating the **DYNAMIC** mode. There is no S position on the selector lever.

- Applies to vehicles with tiptronic gearbox:
- If the lever is moved accidentally to N when driving, release the accelerator and let the engine speed drop to idling before selecting D or S again.
- For the sake of fuel economy (and the environment), the gearbox ratios on some models are designed so that maximum speed is only obtained when the selector lever is at position S. ■

Applies to vehicles: with multitronic® or tiptronic

### Selector lever lock

*The selector lever lock prevents gears from being engaged inadvertently, so that the vehicle is not set in motion unintentionally.*



Fig. 179 Selector lever lock functions

The selector lever lock is released as follows:

- Switch on the ignition.
- Press the brake pedal *and* at the same time press in the interlock button.

#### Automatic selector lever lock

The selector lever is locked in the P and N positions when the ignition is on. The brake pedal must be depressed before the lever can be moved out of either of these positions. The following message appears in the instrument display as a reminder for the driver when the selector lever is in position P or N:

#### WHEN STATIONARY APPLY FOOTBRAKE WHILE SELECTING GEAR.

The selector lever lock only works if the vehicle is stationary or driving at speeds up to 5 km/h. At higher speeds the selector lever lock in the N position is disengaged automatically.

The selector lever lock is not engaged if the selector lever is moved quickly through position N (e.g. when shifting from R to D). This

makes it possible, for instance, to “rock” the vehicle backwards and forwards if it is stuck in snow or mud. The selector lever lock engages automatically if the brake pedal is not depressed and the lever is in position N for more than about a second.

#### Interlock button

The interlock button on the selector lever handle prevents the driver from inadvertently engaging particular gears. Press the button in to disengage the selector lever lock. The illustration shows the selector lever positions in which the button has to be pressed, highlighted in colour ⇒ fig. 179.

#### Safety interlock for ignition key

The key can only be withdrawn with the ignition switched off and the selector lever in position P. When the ignition key is removed, the selector lever is locked in position P. ■

Applies to vehicles: with multitronic® or tiptronic

### Kick-down feature

*The kick-down feature is designed to give maximum acceleration.*

#### Applies to vehicles with multitronic® gearbox

When the accelerator pedal is pressed right down past the point of resistance at full throttle, the gearbox will select a lower gear ratio, depending on road speed and engine speed. While you keep the accelerator depressed the engine speed is automatically controlled to give your vehicle maximum acceleration.

#### Applies to vehicles with tiptronic gearbox

When the accelerator pedal is pressed right down past the point of resistance at full throttle, the gearbox will shift down to a lower gear, depending on road speed and engine speed. The upshift to the next higher gear is delayed until the engine reaches maximum rpm. ►

**! WARNING**

Please note that if the road surface is slippery or wet, the kick-down feature could cause the driving wheels to spin, which could result in skidding. ■

Applies to vehicles: with multitronic® or tiptronic

**Dynamic gear control program (DCP)**

The automatic gearbox is controlled electronically.

The vehicle is equipped with an electronically controlled gearbox. The gear ratios are selected automatically according to preset gear-shift programmes.

When you drive at **moderate speeds** the gearbox will select the most economical shift programme. It will then change up early and delay the downshifts to give better fuel economy.

If you drive at **higher speeds** with heavy acceleration, if you open the throttle quickly, or if you use the kick-down or the car's maximum speed, the gearbox will automatically select the more "sporty" shift programmes.

The gearbox is self-adapting, and continuously selects the most suitable shift programme. At the same time, the driver can also make the gearbox switch to a more "sporty" programme by pressing the accelerator quickly. Depending on road speed, this makes the gearbox shift down early into a lower gear ratio for more rapid acceleration (for instance to pass another vehicle), without having to press the accelerator all the way down into the kick-down position. After the gearbox has shifted back up it returns to the original programme, depending on your style of driving.

Vehicles with multitronic® gearbox: The gearbox continuously adapts the gear ratios on uphill gradients. If the brake pedal is pressed on a downhill gradient the gearbox automatically shifts to a lower gear ratio. This increases the engine braking effect.

Vehicles with tiptronic gearbox: The gearbox adapts the gearshifts for uphill and downhill gradients. This prevents the gearbox from shifting up and down unnecessarily on uphill gradients. ■

Applies to vehicles: with multitronic® or tiptronic

**Manual gear selection (tiptronic mode)**

With the manual shift programme (tiptronic) the driver can manually select pre-programmed gears.

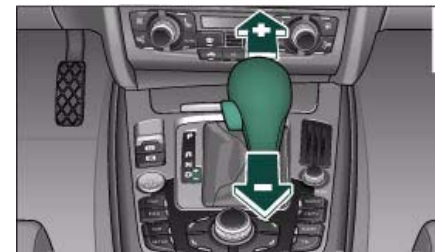

Fig. 180 Centre console: Manual gear selection (tiptronic mode)



Fig. 181 Display: Manual gear selection (tiptronic mode)

**Switching over to the manual programme**

- From position D, push the selector lever to the right. As soon as the automatic gearbox has changed over to this programme, the display will show the selected gear. ►



### Shifting up a gear

- Briefly push the selector lever forwards (in the tiptronic gate) ⇒ *page 166*, fig. 180 (+).

### Shifting down a gear

- Briefly pull the selector lever backwards (in the tiptronic gate) (-).

With the tiptronic system the driver can manually choose between 7 different pre-programmed gears. The manual programme can be selected either with the vehicle stationary or on the move.

When accelerating, the gearbox automatically shifts up into the next gear shortly before the maximum engine speed is reached.

If you select a gear which is lower than the gear shown in the instrument display ⇒ *page 166*, fig. 181, the gearbox will only shift down when there is no longer a risk of overrevving the engine.

When the vehicle slows down (for instance when braking), the gearbox automatically shifts down into the next gear when the minimum engine speed is reached.

Changing down to a lower gear increases the engine braking effect on downhill gradients.

When the accelerator pedal is pressed right down past the point of resistance at full throttle, the gearbox will select a lower gear, depending on road speed and engine speed. ■

Applies to vehicles: with multitronic® or tiptronic

### Back-up programme

*A back-up system is in place should a fault occur in the control system.*

The automatic gearbox switches to the back-up programme if a fault should occur in the control system. This is indicated by all segments

of the display panel either lighting up together or going out completely.

It is still possible to move the selector lever to all positions. The manual shift programme (tiptronic) is not available when the back-up programme is active.

Vehicles with tiptronic gearbox: When the selector lever is in position D or S or in the manual shift programme, the gearbox will remain in 3rd gear if 1st, 2nd or 3rd gears were engaged when the fault occurred. The gearbox will remain in 5th gear if 4th, 5th or 6th gears were engaged. The gearbox will then engage 3rd gear when you drive away from a standstill or after the engine is restarted.

It will still be possible to use reverse gear in the normal way. However, the electronic lock for reverse gear will be switched off.

### ⚠ Caution

Should the gearbox ever switch into the back-up programme, you should take the vehicle to an Audi dealer or qualified workshop as soon as possible. ■

Applies to vehicles: Paddle levers

### Steering wheel with paddle levers

*The paddle levers on the steering wheel enable the driver to manually select pre-programmed ratios or gears.*

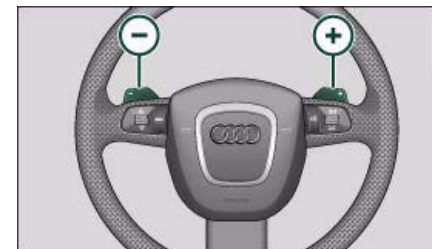

Fig. 182 Steering wheel: tiptronic switches

- Briefly pull the left-hand paddle lever  $\ominus$  to change down to a lower gear.
- Briefly pull the right-hand paddle lever  $\oplus$  to change up to a higher gear.

The paddle levers are activated when the selector lever is in position D or S, or the position for the manual shift programme (tiptronic).

The manual shift programme can, of course, still be operated using the selector lever in the centre console. ■

Applies to vehicles: with multitronic® or tiptronic

### Manual release of selector lever

*The selector lever can be released manually if the electrical power supply should fail.*

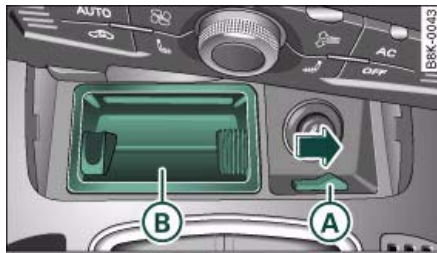

Fig. 183 Removing ashtray



Fig. 184 Manual release of selector lever

The manual release mechanism is behind the ashtray.

- Slide open the cover for the ashtray.
- Slide the switch  $\textcircled{A}$   $\Rightarrow$  fig. 183 to the right to release the ashtray.
- Take out the ashtray  $\textcircled{B}$ .
- You will now see a small cover cap at the front of the opening in the ashtray mounting unit.
- Loosen and remove this cover cap.
- Use a screwdriver or similar object to press down the pin, which is now accessible, and hold it down  $\Rightarrow$  fig. 184.
- Now press the interlock button on the selector lever and move the selector lever to position N.

The selector lever can only be moved out of position P if the ignition key is inserted and the ignition is switched on. If the power supply should ever fail (discharged battery, etc.) and the vehicle has to be pushed or towed, the selector lever must first be moved to position N. This is possible after operating the manual release mechanism. ■

## Parking aid

Applies to vehicles: with Audi parking system/plus/advanced

### General notes

Various systems are available to help you when parking or manoeuvring in tight spaces, depending on the equipment fitted on your vehicle.

The **Audi parking system** gives an acoustic warning if there are any obstacles *behind* the car ⇒ *page 169*.

When you are parking, the **Audi parking system plus** warns you acoustically and optically about obstacles *in front of* and *behind* the vehicle ⇒ *page 170*.

In conjunction with a reversing camera, the **Audi parking system advanced** shows a picture of the area behind the vehicle. This picture helps you to manoeuvre the vehicle backwards and sideways. In addition, you are assisted by the acoustic signals and graphic display of the parking aid ⇒ *page 171*.

#### Note

To ensure that the acoustic parking aid works properly, the sensors must be kept clean and free of snow and ice. ■

## Audi parking system

Applies to vehicles: with Audi parking system

### Description

*The Audi parking system is an acoustic parking aid.*

Sensors are located in the rear bumper. When the sensors detect an obstacle, you are alerted by acoustic signals (beeps). The measuring range of the sensors starts at about:

Rear	Side	0.60 m
	Centre	1.60 m

The acoustic signals sound with increasing frequency as you approach the obstacle. A warning tone will sound continuously when the vehicle is less than approx. 0.30 m away from the obstacle. Stop reversing immediately!

The volume of the warning beeps will be gradually reduced after about 4 seconds if the vehicle remains at a constant distance from a detected obstacle (it will not be reduced if the obstacle is closer than 0.30 m).

The parking aid is switched on automatically when reverse gear is engaged. You will hear a brief acknowledgement tone.

#### WARNING

- The parking aid cannot replace the full concentration of the driver. The driver is always responsible for safety during parking and other manoeuvres.
- The sensors have blind spots in which obstacles are not registered. It is particularly important to ensure that there are no small children or animals near the vehicle, as the sensors may not always be able to detect them.
- Always keep a close watch on the area around the vehicle and make full use of the rear-view mirrors.

#### Caution

Please note that low obstacles detected by the system may no longer be registered by the sensors as the car moves closer, so the system will not give any further warning. Certain kinds of obstacles (such as wire fences, chains, thin painted posts or trailer draw bars, ►

etc.) may not always be detected by the system, so take care not to damage the vehicle in such cases.



### Note

- Please refer to the notes on towing ⇒ page 177.
- You can adjust the volume and pitch of the beeps ⇒ page 177. ■

## Audi parking system plus

Applies to vehicles: with Audi parking system plus

### Description

*The Audi parking system plus is a parking aid with acoustic signals and graphic display.*

Sensors are located in the front and rear bumpers. When the sensors detect an obstacle, you are alerted by acoustic signals (beeps) and a graphic display. The measuring range of the sensors starts at about:

Front	Side	0.90 m
	Centre	1.20 m
Rear	Side	0.60 m
	Centre	1.60 m

The acoustic signals sound with increasing frequency as you approach the obstacle. A warning tone will sound continuously when the vehicle is less than approx. 0.30 m away from the obstacle. Stop moving immediately!

The volume of the warning beeps will be gradually reduced after about 4 seconds if the vehicle remains at a constant distance from a detected obstacle (it will not be reduced if the obstacle is closer than 0.30 m). ■

Applies to vehicles: with Audi parking system plus

### Switching on/off



Fig. 185 Centre console: Parking aid switch



Fig. 186 Display: Graphical distance display

### Switching on

- Switch on the sound system or MMI\*.
- Engage reverse gear, or
- Press the switch  $PWA$  in the centre console ⇒ fig. 185 or next to the selector gate. You will hear a brief acknowledgement tone and the diode in the switch will light up.

### Switching off

- Drive forwards faster than 10 km/h, or

- Press the switch  $P_{\text{A}}$ , or
- Switch off the ignition.

#### Segments in the graphic display

You can estimate the distance to an obstacle by referring to the red segments at the front and rear of the vehicle  $\Rightarrow$  *page 170*, fig. 186. The closer the vehicle gets to the obstacle the closer the segments move towards the vehicle in the graphic. At the latest when the penultimate segment is highlighted the vehicle has reached the danger (collision) zone. Stop moving immediately  $\Rightarrow$  .

#### WARNING

- The parking aid cannot replace the full concentration of the driver. The driver is always responsible for safety during parking and other manoeuvres.
- The sensors have blind spots in which obstacles are not registered. It is particularly important to ensure that there are no small children or animals near the vehicle, as the sensors may not always be able to detect them.
- Always keep a close watch on the area around the vehicle and make full use of the rear-view mirrors.

#### Caution

Please note that low obstacles detected by the system may no longer be registered by the sensors as the car moves closer, so the system will not give any further warning. Certain kinds of obstacles (such as wire fences, chains, thin painted posts or trailer draw bars, etc.) may not always be detected by the system, so take care not to damage the vehicle in such cases.

#### Note

- You can change the display and adjust the volume and pitch of the beeps  $\Rightarrow$  *page 177*.

- Please refer to the notes on towing  $\Rightarrow$  *page 177*.
- There is a slight delay in the picture display. ■

## Audi parking system advanced

Applies to vehicles: with Audi parking system advanced

### Introduction

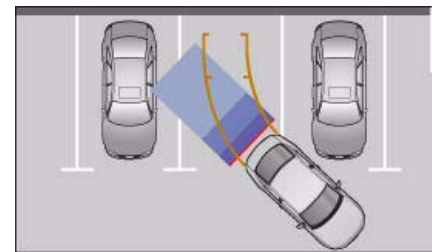

Fig. 187 Viewed from above: Parking mode 1

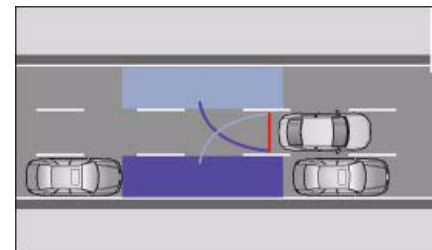



Fig. 188 Viewed from above: Parking mode 2

A **reversing camera** is integrated in vehicles with the Audi parking system advanced, in addition to a parking aid with acoustic signals and graphic display  $\Rightarrow$  *page 170*.

Two modes can be selected when parking. "Parking mode 1" can, for example, be used when parking your vehicle in a parking bay or a 

garage ⇒ fig. 187. Select “parking mode 2” if you wish to park parallel to the roadside ⇒ fig. 188. ■

Applies to vehicles: with Audi parking system advanced

### Description

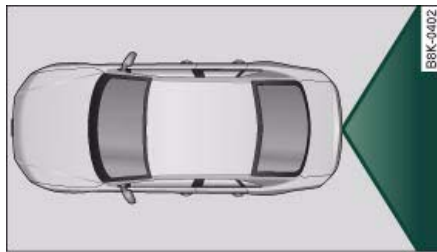

Fig. 189 Viewed from above: Area covered by the reversing camera

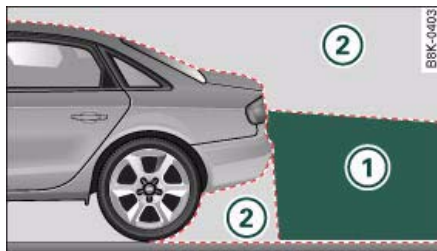

Fig. 190 Side view: ①: Area covered by the reversing camera; ②: area NOT covered by the reversing camera

The reversing camera covers approximately the area depicted in ⇒ fig. 189 and ⇒ fig. 190 ①. This is the area you will see in the picture on the MMI display. Orientation lines and colour markings are projected onto the picture to help you when parking or manoeuvring in tight spaces. Objects out of range of the camera in area ② do not appear in the picture on the MMI display. ■

Applies to vehicles: with Audi parking system advanced

### General notes



Fig. 191 Boot lid: Location of reversing camera

We recommend that you practise parking with the reversing camera in a quiet location (car park or similar) in order to become familiar with the system, including the orientation lines and all the other features. Ideally, the weather and light conditions should be good.

Vehicles or other objects shown in the MMI display appear to be further away or closer, if:



- you are reversing from a horizontal surface up a gradient or down a hill,
- you are reversing towards protruding objects,
- the vehicle has been loaded with a greater load on the rear.

The accuracy of the orientation lines and the blue area markings decreases if:

- the reversing camera does not provide a reliable image, e.g. if visibility is poor or the lens is dirty,
- the sun is so dazzling that you cannot see the image on the display screen.

### How to clean the lens of the reversing camera

The reversing camera is located above the rear number plate. To ensure that the parking aid works properly, the lens ⇒ fig. 191 must be kept clean. ►

- Moisten the lens using a commercially available, alcohol-based glass cleaning agent and clean the lens with a dry cloth ⇒ .
- Use a small brush to remove snow and a de-icer spray to remove ice ⇒ .

### WARNING

- **The parking aid cannot replace the full concentration of the driver. The driver is always responsible for safety during parking and other manoeuvres.**
- **Always keep a close watch on the area around the vehicle and make full use of the rear-view mirrors.**
- **Do not allow the camera images in the MMI display to distract you from watching the traffic.**
- **For safety reasons, you should not use the system if the position and installation angle of the camera have been changed, e.g. in a rear-end collision. Have it checked by a qualified workshop.**

### Caution

- Please note that low obstacles detected by the system may no longer be registered by the sensors as the car moves closer, so the system will not give any further warning. Certain kinds of obstacles (such as wire fences, chains, thin painted posts or trailer draw bars, etc.) may not always be detected by the system, so take care not to damage the vehicle in such cases.
- Never remove snow and ice from the lens of the reversing camera using warm or hot water - danger of cracks appearing on the lens.
- Never use abrasive cleaning agents on the lens. ■

Applies to vehicles: with Audi parking system advanced

### Switching on/off

*The reversing camera is automatically switched on together with the acoustic signals and graphic display when you select reverse gear.*

#### Switching on

- Switch on the MMI system.
- Engage reverse gear, or
- Press the switch  in the centre console ⇒ page 170, fig. 185. You will hear a brief acknowledgement tone and the diode in the switch will light up.

#### Switching off

- Drive forwards faster than 10 km/h, or
- Press the switch ,
- Switch off the ignition.

#### Changing display via MMI

- Press the control button for **Graphic** ⇒ page 174, fig. 192  to show the graphic display on the screen.
- Press the control button for **Rear View** to display the picture from the reversing camera.

### WARNING

- **Some objects (e.g. narrow posts or bars), recesses in the ground or protruding parts on other vehicles may not be displayed in a satisfactory manner or may not be displayed at all on the MMI screen.**

**⚠ WARNING (continued)**

- Only use the reversing camera to assist you if it is supplying you with a good and clear picture. The quality of the picture could be impaired by adverse light, dirt on the lens or a defect (accident risk).
- Only use the reversing camera when the boot lid is completely closed. Please make sure that there are no objects mounted to the rear end of the vehicle which could block the view of the reversing camera.

**i Note**

- If your vehicle is near an obstacle, the graphic display will also appear in the reversing camera image. This superimposed graphic helps the driver to localise the critical area of the vehicle.
- You can change the display and adjust the volume and pitch of the beeps ⇒ *page 177*.
- Please refer to the notes on towing ⇒ *page 177*.
- There is a slight delay in the picture display. ■

Applies to vehicles: with Audi parking system advanced

**Parking perpendicular to the roadside**

*Parking mode 1 can be used when parking your vehicle in a garage or parking bay.*

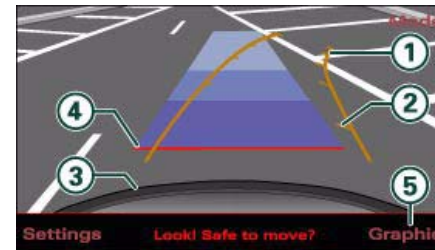

Fig. 192 MMI display: Approaching a parking space

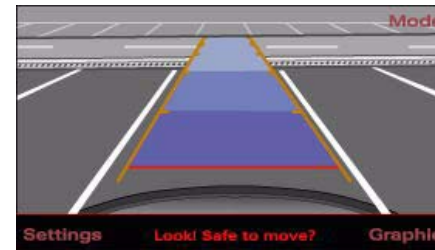

Fig. 193 MMI display: Aligning the vehicle

- Turn the steering wheel until the orange orientation lines ① are pointing towards the parking space ⇒ fig. 192. You can estimate the distance to an obstacle by referring to the markings ②. Each marking is equivalent to 1 metre.



- Reverse into the space and adapt the steering angle to the parking space, using the orange lines to assist you ⇒ ①. ③ indicates the rear bumper. You should stop reversing, at the latest, when the red orientation line ④ is bordering on an object ⇒ ⚠!
- Align your vehicle according to the blue area marking ⇒ fig. 193. The blue marking is an extension of the vehicle outline and reaches about five metres to the rear of the vehicle. The shade of blue changes at a distance of approx. 1 m, 2 m and 5 m to the vehicle.

### ⚠ WARNING

- The reversing camera does not show the complete area behind the vehicle. It is particularly important to ensure that there are no small children or animals near the vehicle, as the reversing camera may not always be able to detect them (accident risk).
- Please note that objects which are not touching the ground may appear to be further away than they actually are (e.g. the bumper of a parked vehicle, a towing bracket or the rear end of a truck). In this case you should not use the orientation lines as a guide when parking the car - accident risk!

### ⚠ Caution

The MMI display shows the path of the rear end of the vehicle if you were to reverse using the current steering angle. NB: The front end of the vehicle swings out further than the rear. Please make sure you keep a sufficient distance between the vehicle and any obstacles to make sure that the exterior mirror or edge of the vehicle do not collide with the obstacle (accident risk). ■

Applies to vehicles: with Audi parking system advanced

### Parking parallel to the roadside

*Parking mode 2 can be used when parking your vehicle at the roadside.*

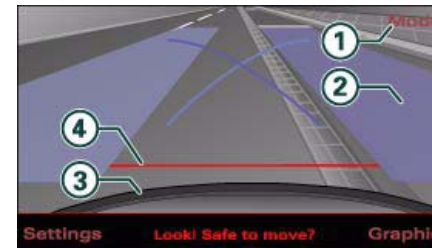

Fig. 194 MMI display: Blue area marking aligned in parking space

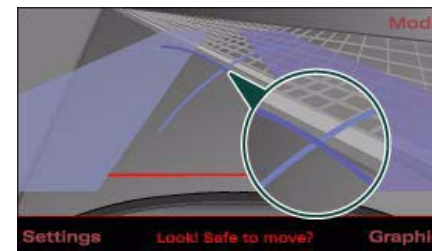

Fig. 195 MMI display: Blue marking touches edge of pavement

The following steps apply only when there are no obstacles (such as a wall) next to the parking space. Otherwise, please follow the "Instructions for parking next to obstacles".

- Position your vehicle parallel to the roadside, about a metre away from the next parked vehicle.
- Engage reverse gear. The parking aid will be switched on and parking mode 1 will be displayed. ►

- Press the control button for **Mode** ⇒ fig. 194 ① on the MMI control console. Parking mode 2 is displayed.
- Reverse and align your vehicle in such a way that the blue area marking ② borders onto the vehicle behind or onto the parking space line marking. The blue marking is an extension of the vehicle outline and reaches about five metres to the rear of the vehicle. The long side of the blue marking should border onto the kerb. The complete blue area marking must fit into the parking space.
- When the vehicle is stationary turn the steering wheel to the left as far as it will go.
- Reverse into the parking space.
- Stop the vehicle as soon as the blue curve touches the kerb ⇒ *page 175, fig. 195.*
- When the vehicle is stationary turn the steering wheel to the right as far as it will go.
- Continue to reverse into the parking space until the vehicle is standing parallel to the kerb. ③ indicates the rear bumper. You should stop reversing, at the latest, when the red orientation line ④ is bordering on an object ⇒ ⚠! Keep a close watch on the front of your vehicle ⇒ ⚠!

#### Parking next to obstacles

If an obstacle (such as a wall) is located next to the parking space, the clearance at the side of the vehicle must be larger. Position the long side of the blue marking so that there is sufficient clearance from the kerb. The marking must not touch the kerb. You must also start turning the steering wheel much earlier. The blue curve ⇒ *page 175, fig. 195* must **not** touch the kerb - make sure there is sufficient clearance from the kerb.

#### ⚠ WARNING

- The reversing camera does not show the complete area behind the vehicle. It is particularly important to ensure that there are no small children or animals near the vehicle, as the reversing camera may not always be able to detect them (accident risk).
- Please note that objects which are not touching the ground may appear to be further away than they actually are (e.g. the bumper of a parked vehicle, a towing bracket or the rear end of a truck). In this case you should not use the orientation lines as a guide when parking the car - accident risk!

#### ⚠ Caution

The MMI display shows the path of the rear end of the vehicle if you were to reverse using the current steering angle. NB: The front end of the vehicle swings out further than the rear. Please make sure you keep a sufficient distance between the vehicle and any obstacles to make sure that the exterior mirror or edge of the vehicle do not collide with the obstacle (accident risk).

#### ℹ Note

The orientation lines and markings appear on the left or right side, depending on which turn signals are on. ■

Applies to vehicles: with Audi parking system/plus/advanced

## Switching display and acoustic signals on and off

The settings for the graphic display\* and acoustic signals are controlled via the sound system or MMI\*.



Fig. 196 Display: Settings for parking aid

- Select: Function selector button **CAR** > **Audi parking system**.

### Display\*

- **off** - The parking aid gives only acoustic warning signals when it is activated.
- **Graphic** - The graphic display appears when reversing and driving forwards.
- **Rear View\*** - The picture from the reversing camera is shown when reversing and driving forwards.
- **Automatic\*** - The picture from the reversing camera is shown when reversing and the graphic display is shown when driving forwards.

### Warning beeps

- **Rear volume** - Volume of the rear sensors
- **Rear frequency** - Pitch of the rear sensors

- **Front volume\*** - Volume of the front sensors
- **Front frequency\*** - Pitch of the front sensors

You will hear a short test tone each time you make a new setting.

### Note

- You can also change the warning beep settings directly from the graphic display\* or reversing camera\* picture. Simply press the control button for **Settings**\*.
- New settings are not activated until you switch on the parking aid again.
- The settings will be automatically stored and assigned to the remote control key. ■

Applies to vehicles: with Audi parking system/plus/advanced and towing bracket

## Towing bracket

In towing mode, the rear parking sensors are NOT activated when you select reverse gear or press the switch **P<sub>0</sub>**. This may not apply if the power socket was NOT factory-fitted. This results in the following restrictions:

### Audi parking system\*

There is no distance warning.

### Audi parking system plus\*

There is no rear distance warning. However, the system will still give a warning when obstacles are detected while driving forwards. The proximity graphic will switch over to towing mode.

### Audi parking system advanced\*

There is no rear distance warning. However, the system will still give a warning when obstacles are detected while driving forwards. The proximity graphic will switch over to towing mode. The image of the ►

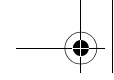

reversing camera will then be shown without orientation lines and blue area markings. ■

Applies to vehicles: with Audi parking system/plus/advanced

### Error messages

If you hear a long beep for a few seconds and the diode in the switch P<sub>u</sub>\* starts flashing when you switch on the parking aid, a system fault has occurred. Please have the fault corrected by an Audi dealer or qualified workshop.



#### Note

If the fault is not corrected before you switch off the ignition, it will only be indicated by the flashing diode in the switch P<sub>u</sub>\* the next time you switch on the parking aid. ■

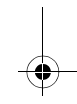
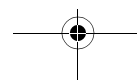
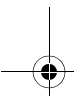
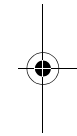
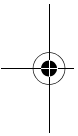

## HomeLink

### Universal transmitter

Applies to vehicles: with HomeLink

#### Description

*The HomeLink universal transmitter can be programmed to replace the hand-held controls of devices already in use.*

HomeLink allows you to conveniently activate garage doors, estate gates, security systems, home or office lighting and other electric devices by means of control buttons inside your car.

HomeLink can replace up to three hand-held transmitters operating existing devices on your property with a single universal transmitter. This will be possible for most transmitters which control the drive units for a garage door or external gates, etc. You can programme the individual hand-held transmitters for your remote control at or near the centre of the radiator grille. This is where the control unit is located.

To be able to control systems with HomeLink, you need to perform initial programming on the HomeLink transmitter first. If systems fail to respond after the initial programming, check whether these systems work with a "rolling code" (variable security code) ⇒ *page 180*.

#### WARNING

**When you are programming the HomeLink universal transmitter, make sure that no persons or objects are close to the devices receiving the transmitter signals. If a gate or door is inadvertently set into motion during programming, persons might be injured or other damage caused by moving parts.**

#### Note

- For additional information on HomeLink® and/or products compatible with HomeLink®, please call the toll-free HomeLink® hotline (0) 08000466 35465 or alternatively +49 (0) 6838 907 277, or visit the HomeLink® website at: [www.homelink.com](http://www.homelink.com)
- HomeLink® is a registered trademark of Johnson Controls. ■

Applies to vehicles: with HomeLink

#### Programming the universal transmitter

*The HomeLink unit is programmed at the radiator grille.*

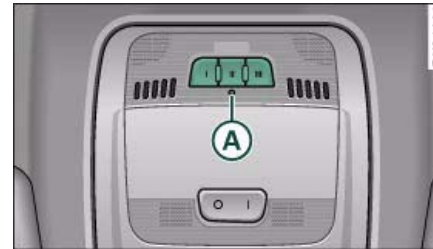

Fig. 197 Operating unit in headliner

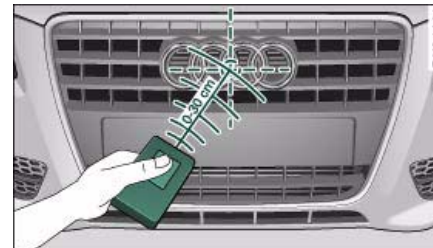

Fig. 198 Radiator grille ►

Controls

Safety

Driving tips

General maintenance

Self-help

Technical data

### At the operating unit

1. Switch on the ignition (do not start the engine).
2. Press and hold down the two outer HomeLink buttons  
 ⇒ *page 179*, fig. 197 until the indicator diode **(A)**  
 ⇒ *page 179*, fig. 197 begins to flash after about 20 seconds. This procedure will delete the standard factory settings and does **not** need to be repeated when programming the other buttons.
3. Press the particular HomeLink button which you would like to program.
4. Wait until the diode **(A)** begins to flash. The HomeLink module now remains in training mode for 5 minutes.
5. Now step in front of your vehicle with the **original hand-held transmitter** for the garage door opener or any other device you wish to assign to the HomeLink control button.

### At the radiator grille

6. Hold the **original hand-held transmitter** at or near the centre of your car's radiator grille ⇒ *page 179*, fig. 198.
7. Press the activator button on the **original hand-held transmitter**.
8. As you do so, watch the turn signals on your vehicle. HomeLink confirms successful programming by flashing all four turn signals **three times**.
9. If the turn signals fail to flash three times, repeat the procedure with the transmitter held at a different distance from the radiator grille.

The proper distance between the hand-held transmitter and the HomeLink module at the radiator grille depends on the system you want to train. It may require several attempts.

The turn signals will flash **once** if the time limit for the programming mode has been exceeded. In this case the programming procedure needs to be performed again. Repeat the sequence at the operating unit starting with step 3.

The programming instructions above also apply to the other control buttons. Start with step 3 if you wish to proceed and program the other two buttons.

If the garage door or other devices still fail to be activated with the HomeLink control buttons after programming is completed, it is possible that these systems might be working with a rolling code instead of the normal fixed security code. If this is the case, a **rolling code programming** is required in addition to the steps described above. ⇒ *page 180* ■

Applies to vehicles: with HomeLink

### Rolling code programming

*Some devices require rolling code programming of the HomeLink universal transmitter.*

#### Identifying a rolling code

- Press the already programmed HomeLink button again and hold it down.
- Watch HomeLink diode **(A)** ⇒ *page 179*, fig. 197. If the diode starts flashing rapidly and turns into a constant light after about 2 seconds, this indicates that the device you wish to operate (e.g. a garage door opener) is equipped with a rolling code.
- Program the rolling code as follows: ►

### Activating the garage door opener drive unit

- Locate the programming button on the garage door drive. The exact location and colour of the button may vary depending on the type of garage door opener.
- Press the programming button on the door drive unit (this will normally cause a “programming mode indicator lamp” on the unit to light up). You now have about **30 seconds** to start and complete the programming of the HomeLink control button on the operating unit.

### Programming at the operating unit in the headliner

- Press and release the already programmed HomeLink button.
- Press the HomeLink button again to complete rolling code programming.

After programming at the operating unit in the headliner, the garage door opener should recognize the HomeLink signal and respond when the HomeLink button is pressed. Now the other control buttons can be programmed as required.

#### Note

- Having a second person assist you makes programming of the rolling code easier and faster. For some makes of garage door openers the HomeLink button may have to be pressed a third time to complete the training sequence.
- If you encounter problems programming the rolling code you may find helpful information in the operating instructions of the garage door opener or other device you wish to operate. ■

Applies to vehicles: with HomeLink

### Operating HomeLink

*The programmed devices are activated by means of the HomeLink control buttons in the headliner.*

- Make sure that the ignition is on.
- Press the programmed HomeLink button ⇒ *page 179, fig. 197*. The device assigned to that button (e.g. garage door) will be activated.

The HomeLink indicator diode ⇒ *page 179, fig. 197* will light up when you press the button. ■

Applies to vehicles: with HomeLink

### Erasing the button programming

*You can erase the complete HomeLink programming by pressing the two outer buttons.*

- Switch on the ignition (do not start the engine).
- Press and hold down the two outer buttons until the indicator diode starts to flash ⇒ *page 179, fig. 197*.
- Then release the buttons.

After the programming of the HomeLink buttons has been erased, the system will return to the training mode and is ready to be re-programmed at any time.

#### Note

- Programmed buttons cannot be erased individually.
- For security reasons it is advisable to erase the programming of the HomeLink buttons prior to selling your vehicle. ■

Applies to vehicles: with HomeLink

### Re-programming a button

*A HomeLink button can be re-programmed individually without affecting the other button allocations.*

#### At the operating unit in the headliner

- Press and hold down the selected button until the indicator diode ⇒ *page 179*, fig. 197 starts flashing slowly.

#### At the radiator grille

- Hold the **original hand-held transmitter** for the garage door opener or other device directly in front of the radiator grille of your vehicle (at or near the centre) ⇒ *page 179*, fig. 198. The exact distance depends on the system that you want to program.
- Press the button on the **original hand-held transmitter** for the garage door opener or other device.
- As you do so, watch the turn signals on your vehicle. HomeLink confirms successful programming by flashing all four turn signals **three times**.
- If the turn signals fail to flash three times, repeat the procedure with the transmitter held at a different distance from the radiator grille.

When the turn signals have flashed three times, this means the device previously stored in HomeLink has been erased and the new system programmed in its place. To activate the new system, press the HomeLink button that has just been re-programmed.



#### Note

It may require several attempts before programming is successful. When programming a new device, keep the button pressed for at

least 15 seconds before trying again with the transmitter in a different position. Keep watching the turn signals during that time. ■

Applies to vehicles: with HomeLink

### Conformity certification

The HomeLink universal transmitter is registered in the following countries under the following certification numbers:

Country	Certification number
Andorra	16SEP2003
Belgium	RTT/D/X2064
Denmark	98.3142-266
Germany	D800038K
Finland	FI98080106
France	97619 RD
Gibraltar	RTTE 20754/0087847
Greece	JCI 05JUL2000 RTTE
Great Britain	RTTE 20754/0087847
Republic of Ireland	TRA 24/5/109/5
Iceland	IS-3418-00
Italy	DGPGF/4/341032/TB 0002573
Croatia	SRD-156/03
Luxembourg	L2433/10510-03J
Malta	WT/122/98
Monaco	PC/cp-CI.T55-03/04672
Netherlands	NL99030970
Norway	NO20000026



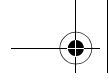

Country	Certification number
Austria	GZ104569-ZB/98
Poland	URT-GP-CLBT-431-66/2002/C
Portugal	JCI 03JUL2000 RTTE
Sweden	Ue990195
Switzerland	BAKOM 98.0746.K.P
Slovak Republic	R 267 2001 N
Spain	0416 00
Czech Republic	CTU 2000 3 R 1194
Turkey	0425/TGM-TR/JOCO-EURO
Hungary	BB-5793-1/2000
Cyprus	MCW129/95 12/2000

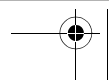
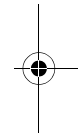
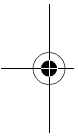

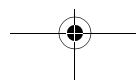
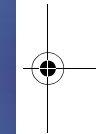
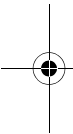

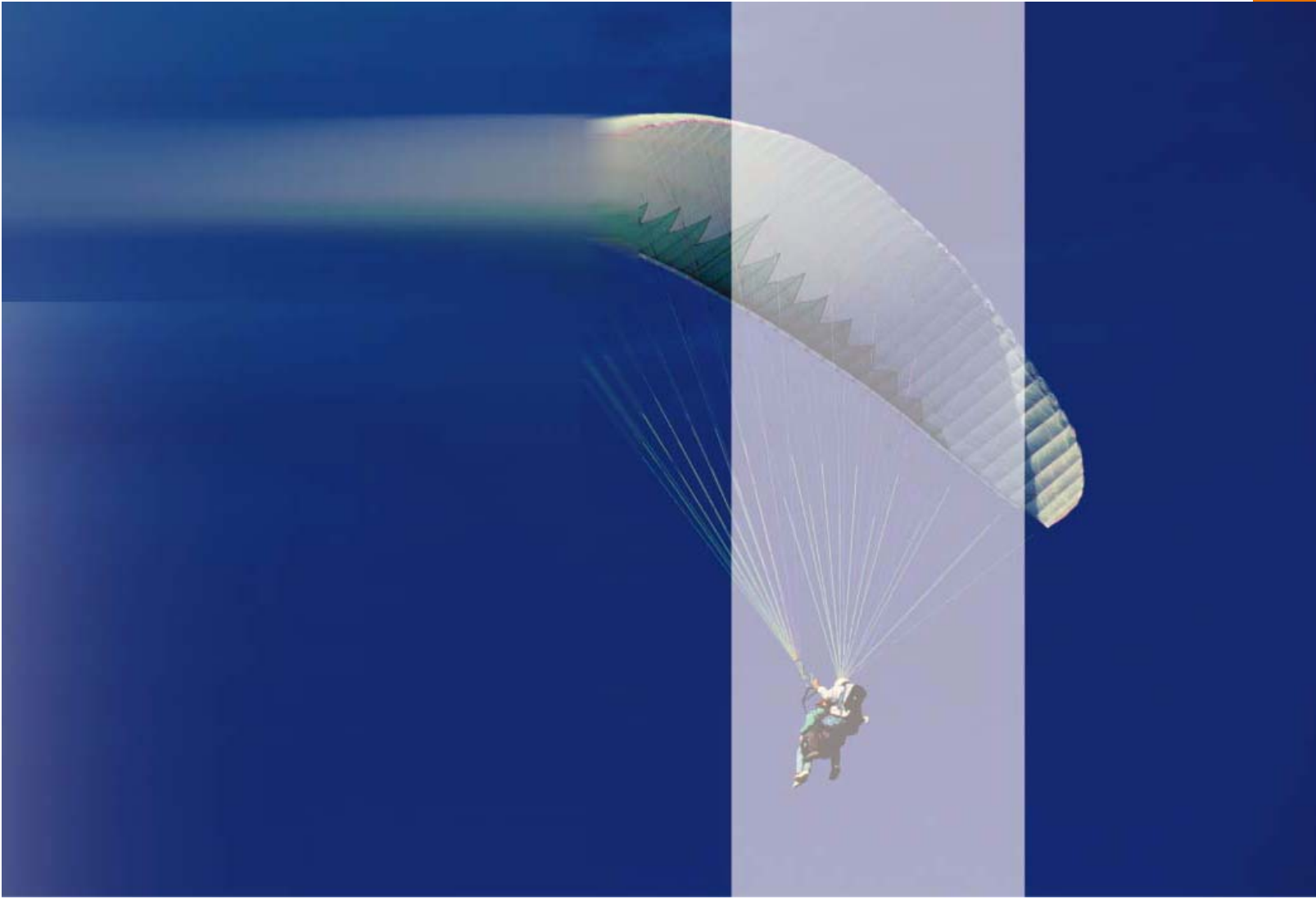
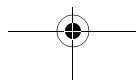
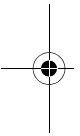
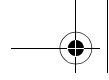

## Safe driving

### General notes

#### Safety is the first priority

*Your safety is our first priority.*

This chapter contains important information, tips, suggestions and warnings that you should read and observe for your own safety and the safety of your passengers.

#### WARNING

- **The information in this chapter is important for the driver of the vehicle and all passengers. The other chapters in this manual (and, where applicable, in the other literature supplied with the vehicle) contain further important notes which you should read and observe for your own safety and that of your passengers.**
- **Ensure that the complete vehicle wallet is always in the vehicle. This is especially important when you lend or sell the vehicle to others. ■**

#### Safety features

*The safety features listed here are part of the vehicle's occupant restraint system. They work together to help reduce the risk of injury in a wide variety of accident situations.*

Your safety and the safety of your passengers should not be left to chance. In the event of an accident, the safety features incorporated in your vehicle are capable of reducing the risk of injury. These are just a few of the safety features in your Audi:

- Optimised three-point seat belts for all seats,

- Belt force limiters for the front seats,
- Belt pre-tensioners for the front seats,
- Head restraints for all seats,
- Optimised protection against injuries of the cervical vertebrae,
- Front airbags,
- Side airbags in the front seat backrests and on the outer rear seats\*,
- Head-protection airbags (sideguard system),
- "ISOFIX" mountings\* for "ISOFIX" child safety seats on the rear seats,
- Height-adjustable head restraints on the seats,
- Adjustable steering column.

These individual safety features are harmonised to provide you and your passengers with the best possible protection in accident situations. However, they can only be effective if you and your passengers sit in the correct position and adjust and use the safety equipment properly.

For these reasons, this chapter explains why these safety features are so important, how they can protect you, what you need to remember when using them, and how you and your passengers can gain the most benefit from them. There are also a number of important safety warnings which you and your passengers should always observe in order to minimise the risk of injury.

**Safety is everyone's responsibility! ■**

### Before every trip

*The driver is responsible for the safety of the passengers and the safe operation of the vehicle at all times.*

For your own safety and the safety of your passengers, always note the following points before every trip:

- Make sure that all lights and turn signals are working properly.
- Check the tyre pressures.
- Make sure that all windows are clean and give good visibility to the outside.
- Secure all luggage and other items carefully ⇒ *page 79*.
- Make sure that no objects can interfere with the pedals.
- Adjust the front seat, head restraint and mirrors correctly.
- Make sure that the head restraints for all passengers are adjusted to the correct position.
- Make sure that children are protected with suitable safety seats and properly worn seat belts ⇒ *page 210*.
- Sit in the correct position in your seat and make sure that your passengers do the same. ⇒ *page 73*.
- Fasten your seat belt correctly. Make sure that your passengers do the same ⇒ *page 194*. ■

### What affects driving safety?

*Safety on the road is directly related to how you drive, and can also be affected by the passengers in the vehicle.*

The driver is responsible for the safety of the vehicle and all its occupants. If your ability to drive is impaired in any way, you endanger yourself and other road users ⇒ . Therefore:

- Do not let yourself be distracted by passengers or by using a mobile phone, etc.
- Never drive when your driving ability is impaired (by medication, alcohol, drugs, etc.).
- Obey all traffic regulations and speed limits and always maintain a safe distance to the vehicle in front.
- Always adjust your speed to suit the road, traffic and weather conditions.
- Take frequent breaks on long trips. Do not drive for more than two hours without a stop.
- If possible, avoid driving when you are tired or stressed.

#### WARNING

- Distractions while driving or any kind of impairment to your driving ability increase the risk of accident and injury.
- Do not store loose objects on the dashboard. These objects could fly around the interior when the vehicle is moving (under acceleration or whilst cornering) and distract the driver – this could lead to an accident. ■

## Correct sitting positions

### Correct sitting position for driver

The correct driving position is important for safe and fatigue-free driving.

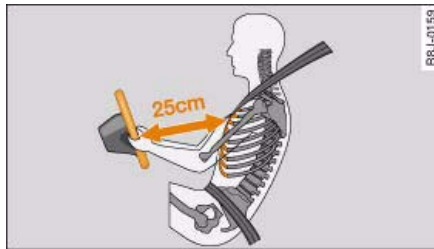

Fig. 199 Minimum distance between driver and steering wheel

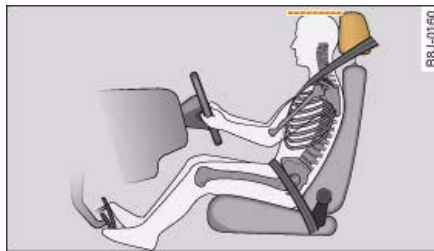

Fig. 200 Correct head restraint position for the driver

For your own safety, and to reduce the risk of injury in the event of an accident, we recommend the following driving position.

- Adjust the steering wheel so there is a distance of at least 25 cm between the steering wheel and your breastbone ⇒ fig. 199.

- Move the driver's seat forwards or backwards so that you can press the accelerator, brake and clutch pedals all the way to the floor with your knees slightly bent ⇒ ⚠.
- Make sure that you can comfortably reach the top of the steering wheel.
- Adjust the head restraint so that the top of the head restraint is level with the top of your head ⇒ fig. 200.
- Adjust the backrest to an upright position so that your back remains in contact with the upholstery.
- Fasten your seat belt correctly ⇒ page 194.
- Keep both feet in the footwell so that you are in full control of the vehicle at all times.

For detailed information on how to adjust the driver's seat, see ⇒ page 73, "Seats and storage".

### ⚠ WARNING

- A driver who is not sitting in the correct position or who is not wearing a seat belt can be fatally injured if the airbag is triggered.
- Adjust the driver's seat so there is a distance of at least 25 cm between your breastbone and the centre of the steering wheel ⇒ fig. 199.
- While driving, always hold the steering wheel with both hands on the outside of the rim at about the 9 o'clock and 3 o'clock position. This reduces the risk of injury if the driver's airbag inflates.
- Never hold the steering wheel at the 12 o'clock position, or with your hands inside the rim or on the steering wheel hub. This could result in serious injuries to the arms, hands and head if the driver's airbag inflates.
- To reduce any risk of injury to the driver during a sudden brake application or in an accident, never drive with the backrest tilted ▶

**⚠ WARNING (continued)**

**too far back. The airbag system and seat belts can only provide proper protection when the backrest is in an upright position and the driver is wearing the seat belt in the correct position. The further the backrest is tilted back, the greater the risk of injury due to incorrect positioning of the belt webbing or an incorrect sitting position.**

- **Adjust the head restraint properly so that it can give maximum protection. ■**

**Correct sitting position for front passenger**

*The front seat passenger must sit at least 25 cm away from the dash panel so that the airbag has enough room to inflate and give maximum protection in an accident.*

For your own safety and to reduce the risk of injury in the event of an accident, we recommend adjusting the front passenger's seat as follows:

- Move the front passenger's seat as far back as possible ⇒ **⚠**.
- Adjust the backrest to an upright position so that your back remains in contact with the upholstery.
- Adjust the head restraint so that the top of the head restraint is level with the top of your head ⇒ *page 190*.
- Keep both feet in the footwell in front of the seat.
- Fasten your seat belt correctly ⇒ *page 197*.

In **exceptional cases** you can disable the front passenger's airbag via the key-operated switch\* ⇒ *page 208*.

For detailed information on how to adjust the front passenger's seat, see ⇒ *page 73, "Seats and storage"*.

**⚠ WARNING**

**A passenger who is not sitting in the correct position or who is not wearing a seat belt can be fatally injured if the airbag is triggered.**

- **Adjust the front passenger's seat so there is a distance of at least 25 cm between your breastbone and the dash panel.**
- **Always keep your feet on the floor when the vehicle is moving; never rest them on the instrument panel, out of the window or on the seat. If you sit in an incorrect position, you increase your risk of injury in the event of sudden braking or an accident. If the airbag is triggered, you could sustain potentially fatal injuries by sitting out of position.**
- **To reduce the risk of injury to the front passenger in the case of sudden braking or an accident, the passenger should never travel in a moving vehicle with the backrest reclined. The airbag system and seat belt can only provide proper protection when the backrest is in an upright position and the passenger is wearing the seat belt in the correct position. The further the backrest is tilted back, the greater the risk of injury due to incorrect positioning of the belt webbing or an incorrect sitting position.**
- **Always adjust the head restraints properly for maximum protection. ■**

**Correct sitting position for passengers in the rear**

*Rear seat passengers should sit upright with both feet on the floor and wear their seat belts properly whenever the vehicle is moving.*

To reduce any risk of injury in the event of sudden braking or an accident, passengers in the rear seats must observe the following: ▶

- Adjust the head restraint so that the top of the head restraint is level with the top of your head ⇒ *page 190*.
- Keep both feet in the footwell in front of the rear seat.
- Fasten your seat belt correctly ⇒ *page 197*.
- Use appropriate child restraint systems for children travelling in the vehicle ⇒ *page 210*.

**! WARNING**

Rear passengers sitting out of position can suffer severe injuries.

- Always adjust the head restraints properly for maximum protection.
- Seat belts only offer maximum protection when the backrest is in an upright position and the passengers are wearing the seat belts properly. By not sitting upright, rear passengers increase the risk of injury due to incorrect positioning of the seat belt webbing. ■

### Correct adjustment of head restraints

*Properly adjusted head restraints are an important part of the vehicle's occupant protection system. They can help to reduce the risk of injuries in most accident situations.*

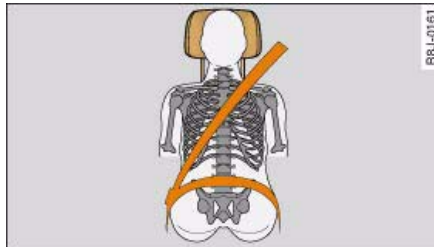

Fig. 201 Correctly adjusted head restraint (seen from the front)

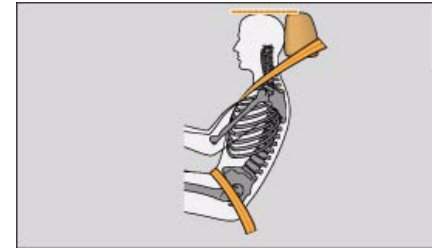

Fig. 202 Correctly adjusted head restraint (seen from the side)

The head restraints must be adjusted properly to provide maximum protection.

- Adjust the head restraint so that the top of the head restraint is level with the top of your head ⇒ *fig. 201* and ⇒ *fig. 202*.

For more information on how to adjust the head restraints, see ⇒ *page 77*.

**! WARNING**

Travelling with the head restraints removed or incorrectly adjusted increases the risk of severe injuries.

- Incorrectly adjusted head restraints could lead to death in the event of a collision or accident.
- Incorrectly adjusted head restraints can also increase the risk of injury during sudden or unexpected braking or other manoeuvres.
- The head restraints must always be adjusted according to the occupant's size. ■



### Examples of incorrect sitting positions

*Occupants can suffer severe or fatal injuries if they sit in an incorrect position while the vehicle is moving.*

Seat belts can only provide maximum protection if the belt webbing is positioned correctly. Sitting out of position greatly reduces the effectiveness of the seat belts and increases the risk of injury since the belt webbing is not worn in the position for which it is designed. The driver is responsible for the safety of all vehicle occupants, especially for children.

- Never allow anyone to sit out of position while the vehicle is moving ⇒ .

The following list shows just some examples of incorrect sitting positions which can be dangerous to all occupants. The list is not complete, but will help to make you aware of possible dangers which can be avoided.

**Therefore, whenever the vehicle is moving:**

- never stand up in the vehicle,
- never stand on the seats,
- never kneel on the seats,
- never travel with the backrest reclined too far,
- never lean against the dash panel,
- never lie down on the rear seat,
- never sit on the front edge of a seat,
- never sit sideways,
- never lean out of the window,
- never put your feet out of the window,
- never put your feet on the dash panel,
- never put your feet on the seat cushion,

- never ride in the footwell,
- never travel on a seat without wearing the seat belt,
- never climb into the luggage compartment.

#### WARNING

**Sitting out of position increases the risk of severe injuries.**

- **Sitting out of position exposes the occupants to potentially fatal injuries: if the airbags inflate they can strike any occupant who is not in one of the designed seat positions.**
- **Before starting a trip, sit in the correct position and stay in this position as long as the vehicle is moving. Before every trip, make sure all passengers are sitting in the correct positions and remain correctly seated at all times ⇒ page 73, "Seats and storage". ■**

### Pedal area

#### Pedals

*The pedals must always be free to move and must never be obstructed by floor mats or any objects in the footwell.*

- Make sure that the accelerator, brake and clutch pedals are not obstructed and can be pressed all the way down to the floor.
- Make sure that all pedals are able to return freely to their original positions.

Only use floor mats which leave the pedal area free and can be securely fastened in the footwell.

If one of the brake circuits should fail, increased brake pedal travel will be required to bring the vehicle safely to a stop. ►

**! WARNING**

Any obstructions that restrict pedal travel can cause loss of vehicle control and critical situations on the road.

- Never place objects in the driver's footwell. Such objects could move under the pedals and interfere with their proper function. In the event of sudden braking or a change of direction, you would not be able to use the pedals. This could result in a loss of control and possibly cause an accident. ■

**Floor mats on the driver's side**

Use only floor mats which can be securely fastened in the footwell and do not obstruct the pedals.

- Make sure that floor mats are securely fastened and cannot interfere with the pedals ⇒ **!**.

Use only floor mats that leave the pedal area unobstructed and are firmly secured to prevent them from slipping. You can obtain suitable floor mats from your dealer or a specialist retailer.

**! WARNING**

Any obstructions that restrict pedal travel can cause loss of vehicle control and increase the risk of serious personal injury.

- Always make sure that floor mats are properly secured.
- Never lay or install additional floor mats or other floor coverings over the existing floor mats; this would restrict the pedal area and possibly obstruct the pedals, which could cause an accident. ■

**Stowing luggage safely****Luggage compartment**

*All luggage and other objects must be safely secured in the luggage compartment.*

Loose items in the luggage compartment can shift suddenly and cause a safety hazard or impair the handling of the vehicle by changing the weight distribution.

- Distribute the load evenly in the luggage compartment ⇒ *page 79*.
- Place heavy items as far forward as possible in the luggage compartment and secure them properly.
- Use the fastening rings\* provided ⇒ *page 193* or the luggage net\* for securing heavy items.

**! WARNING**

• Loose items in the luggage compartment can shift suddenly and cause a safety hazard or impair the handling of the vehicle by changing the weight distribution.

• Always stow objects in the luggage compartment and secure them on the fastening rings\*.

• Transporting heavy objects may affect the vehicle's handling by shifting the centre of gravity – this could cause an accident. Take extra care when driving and adjust your speed accordingly.

• Never exceed the maximum axle loads or the maximum gross weight for the vehicle ⇒ *page 323*, "Performance, weights and dimensions". Exceeding the permitted axle loads or gross weight limit can affect the vehicle's handling characteristics, and increase the risk of accidents, personal injuries or damage to the vehicle.

• Never leave your vehicle unattended when the boot lid is open. Children could climb into the boot and close the boot lid from the

**⚠ WARNING (continued)**

**inside. In this case the child would be unable to get out of the vehicle without help. This could have fatal consequences.**

- **Never allow children to play in or around the vehicle. Always close and lock the boot lid and all the doors when you leave the vehicle.**
- **Never let passengers ride in the luggage compartment. All occupants must be properly restrained by the seat belts at all times ⇒ *page 194*.**

**Note**

- Air circulation in the vehicle helps reduce fogging of the windows. Used air escapes through ventilation slots in the rear of the vehicle. Make sure that these ventilation slots are not obstructed.
- Suitable belts for securing loads to the fastening rings\* are commercially available. ■

Applies to vehicles: with fastening rings

**Fastening rings**

*Unsecured loads are a hazard to all vehicle occupants.*

There are fastening rings in the luggage compartment which can be used to secure luggage and other objects ⇒ *page 79*.

- Use the fastening rings to secure items safely in the luggage compartment ⇒  in “Loading the luggage compartment” on *page 79*.

During a collision or an accident, even small and light objects can possess so much energy that they can cause very severe injuries. The amount of this “kinetic energy” depends on the speed of the

vehicle and the weight of the object. The most significant factor, however, is the speed of the vehicle.

An example: An object weighing 4.5 kg is lying unsecured in the vehicle. During a frontal collision at a speed of 50 km/h, this object generates a force corresponding to 20 times its weight. That means that the effective weight of the object increases to about 90 kg. You can imagine the severity of the injuries which might be sustained if this “projectile” strikes an occupant as it flies through the passenger compartment.

**WARNING**

**If items of luggage or other objects are secured to the fastening rings with inappropriate or damaged retaining cords, injuries could result in the event of sudden braking or a collision.**

- **To prevent pieces of luggage or other objects from flying forward, always use appropriate retaining cords which are properly secured to the fastening rings.**
- **Never secure a child seat on the fastening rings. ■**

## Seat belts

### Why is it so important to use seat belts?

#### Seat belts provide effective protection

*The common belief that passengers can brace their weight with their hands in a minor collision is false.*



**Fig. 203** Driver protected by the properly worn seat belt during a sudden brake manoeuvre

It is an established fact that seat belts provide good protection in accidents. Therefore wearing a seat belt is required by law in most countries.

Properly worn seat belts hold the occupants in the best position for maximum protection ⇒ fig. 203. The seat belts are capable of absorbing much of the kinetic energy arising in a collision. Also they help to prevent uncontrolled movements which could lead to severe injuries ⇒ *page 195*, "Important safety instructions for using seat belts".

If they wear the seat belts correctly, the passengers benefit greatly from the ability of the belts to reduce the kinetic energy gradually. The front crumple zones and other passive safety features (such as the airbag system) are also designed to absorb the kinetic energy generated in a collision. Taken together, all these features reduce

the forces acting on the occupants and consequently the risk of injury.

Although these examples are based on a frontal collision, the physical principles involved are the same in other types of accidents and for vehicles with an airbag system. This is why it is so important to put on the seat belts before every trip – even when "just driving around the corner". Ensure that your passengers wear their seat belts as well ⇒ .

Properly worn seat belts have been shown to be an effective means of reducing the potential for injury and improving the chances of survival in a serious accident ⇒ *page 195*, "Forces acting in a collision".

For information on how children can travel safely in the car ⇒ *page 210*, "Points to remember if children are travelling in the car".

#### **WARNING**

- **Seat belts must be put on before every trip – even when driving in town. This also applies to the rear passengers (injury risk).**
- **During pregnancy, women should always ensure they wear a seat belt. The best way to protect the unborn child is to protect the mother ⇒ *page 198*, "Wearing and adjusting the seat belts during pregnancy". ■**

### Important safety instructions for using seat belts

*There are a number of safety points concerning the seat belts which you should remember. This will help to reduce the risk of injury in an accident.*

#### **⚠ WARNING**

- The seat belts can only provide maximum protection if the seats are adjusted properly ⇒ *page 73, "Seats and storage"*.
- To ensure proper protection, it is important to wear the seat belts in the correct position ⇒ *page 197, "How to wear seat belts properly"*. Ensure that the seat belts are worn exactly as recommended in this chapter. Belts which are not worn properly can increase the risk of injury in accidents considerably.
- Do not allow the seat belt to become twisted or jammed, or to rub on any sharp edges.
- Never allow two passengers (even children) to share the same seat belt. It is especially dangerous to place a seat belt over a child sitting on your lap.
- Do not wear the belt over hard or fragile objects (such as glasses or pens, etc.) because this can cause injuries.
- Loose, bulky clothing (such as an overcoat over a jacket) impairs the proper fit and function of the belts.
- The belts must be kept clean, otherwise the retractors may not work properly ⇒ *page 250, "Seat belts"*.
- The slot in the seat belt buckle must not be blocked with paper or other objects, as this can prevent the latch plate from engaging properly.
- The latch plate of the belt must always be engaged in the correct buckle for that seat, otherwise the belt will not be fully effective.
- Check the condition of the seat belts at regular intervals. If you notice that the belt webbing, fittings, retractor mechanism or

#### **⚠ WARNING (continued)**

**buckle of any of the belts is damaged, the belt must be replaced by a qualified workshop.**

- The seat belts must not be removed or modified in any way. Do not attempt to repair a damaged belt yourself.
- Seat belts which have been worn in an accident and stretched must be replaced by a qualified workshop. The belt anchorages should also be checked. ■

### Forces acting in a collision

#### The physical principles involved in a frontal impact

*Very large forces are generated during a collision; these forces have to be absorbed.*



**Fig. 204** Passengers of a vehicle which is headed for a brick wall. They are not using seat belts.

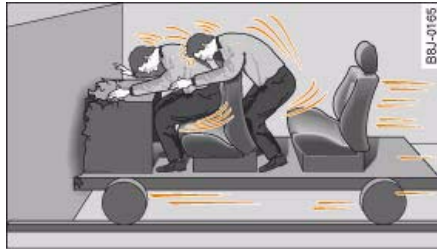

**Fig. 205** The vehicle crashes against the wall

The physical principles involved in a frontal collision are relatively simple:

Both the moving vehicle and the passengers possess energy, which is known as “kinetic energy”  $\Rightarrow$  page 195, fig. 204. The amount of “kinetic energy” depends on the speed of the vehicle and the weight of the vehicle and passengers. The higher the speed and the greater the weight, the more energy there is to be absorbed in an accident.

The most significant factor, however, is the speed of the vehicle. If the speed doubles from 25 km/h to 50 km/h, for example, the kinetic energy increases by a factor of four. Because these passengers are not restrained by seat belts, the entire amount of kinetic energy has to be absorbed at the point of impact  $\Rightarrow$  fig. 205. This would result in serious or potentially fatal injury.

Even at urban speeds of 30 km/h to 50 km/h, the forces acting on the occupants in a collision can reach the equivalent of 1 ton (1000 kg) or more. At greater speed these forces are even higher. A rule of thumb: if the speed doubles, the forces increase by a factor of four.

Passengers who do not wear seat belts are not “attached” to the vehicle. In a frontal collision they will continue to move forward at the speed their car was travelling just before the impact. ■

### What happens to passengers not wearing seat belts?

*Passengers not wearing seat belts risk fatal injuries in the event of an accident.*



**Fig. 206** A driver not wearing a seat belt can be thrown forwards



**Fig. 207** A rear passenger not wearing a seat belt can be thrown forwards

In a frontal collision, unbelted passengers will be thrown forwards and make violent contact with the steering wheel, dashboard, windscreen, etc  $\Rightarrow$  fig. 206. Passengers not wearing their belts risk being thrown out of the car, resulting in potentially fatal injuries.

The common belief that occupants can brace their weight with their hands in a minor collision is false. Even at low speeds the forces acting on the body in a collision are so great that it is not possible to hold oneself in the seat. ▶

It is also important for the rear passengers to wear seat belts, as they could otherwise be thrown forwards violently in an accident. Rear passengers who do not use seat belts endanger not only themselves but also the other occupants ⇒ *page 196, fig. 207*. ■

## How to wear seat belts properly

### Putting on the three-point seat belts

*Always fasten your seat belts before driving off.*



Fig. 208 Positioning of head restraints and seat belts



Fig. 209 Driver's seat: Belt buckle and latch plate

- Adjust the front seat and head restraint correctly before putting on the seat belt ⇒ *page 73, "Seats and storage"*.

- To fasten the belt, take hold of the latch plate and pull it slowly across your chest and lap ⇒ ⚠.
- Insert the latch plate into the buckle for the appropriate seat and push it down until it is securely locked with an audible click ⇒ *fig. 209*.
- Pull the belt to check that it is now securely fastened.

The three-point inertia reel belts are tensioned automatically. The retractor system gives complete freedom of movement, as long as the pull on the belt is slow. Hard braking locks the belt. The belt will also lock when you accelerate, drive up or down a steep hill or in a sharp curve.

#### ⚠ WARNING

- Always make certain that the belt is positioned properly ⇒ *fig. 208* – risk of injury ⇒ *page 197, "Adjusting the seat belts"*.
- The latch plate of the belt must always be engaged in the correct buckle for that seat. Otherwise the belt will not be fully effective and the danger of injury increases. ■

### Adjusting the seat belts

*Always position seat belts properly for maximum safety.*

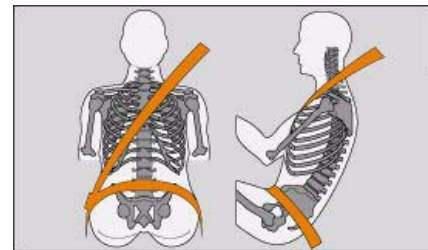

Fig. 210 Adjusting shoulder and lap belt ▶

The height of the front seat on your vehicle can be adjusted in order to match the position of the seat belt to your height.

#### WARNING

- The diagonal part of the belt should never be positioned across the neck, but roughly over the centre of the shoulder; it should fit closely against the upper part of the body. The lap part of the belt must be worn tightly across the hips, and not over the abdomen ⇒ page 197, fig. 210. Pull the belt tight if necessary to take up any slack.
- Always make sure that belt is positioned properly. Incorrectly worn seat belts can give rise to injuries even in a minor collision.
- Seat belts worn too loose can result in injuries because they allow excessive forward movement in a crash; the occupant will be brought to a sudden stop by the belt webbing. ■

#### Wearing and adjusting the seat belts during pregnancy

*To afford the best protection for the unborn child it is important for the mother to wear the seat belt properly at all times.*



Fig. 211 Positioning seat belts during pregnancy

Women should always ensure they adjust the seat belt correctly during pregnancy.

- Adjust the front seat and head restraint correctly before putting on the seat belt ⇒ page 73, “Seats and storage”.
- To fasten the belt, take hold of the latch plate and pull it slowly down across your chest. Wear the lap portion of the seat belt as low as possible over the hips so that there is no pressure on the stomach ⇒ fig. 211, ⇒ .
- Insert the latch plate into the buckle for the appropriate seat and push it down until it is securely locked with an audible click ⇒ page 197, fig. 209.
- Pull the belt to check that it is now securely fastened.

#### WARNING

**During pregnancy, women should especially make sure to wear the lap portion of the seat belt as low as possible across the hips so that there is no pressure on the stomach. ■**



Applies to vehicles:

### Seat belt height adjustment

Seat belt height adjusters can be used to adjust the height of the shoulder portion of the seat belt.

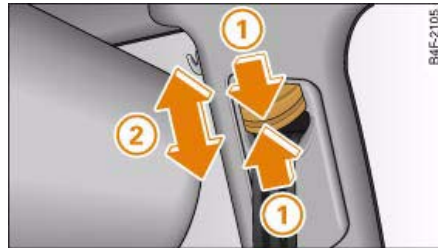

Fig. 212 Belt height adjustment for the front seats: guide fitting

- Take hold of the guide fitting and *slide it up* ⇒ fig. 212 (1), or
- *Compress the adjuster* (2) and *slide the guide fitting downwards* (1).
- After adjusting, pull the shoulder belt sharply to check that the catch on the guide fitting is engaged securely.

#### **i** Note

- The shoulder portion of the seat belt must be positioned roughly midway over the shoulder – **it must never rest against the neck** ⇒ ⚠ in “Adjusting the seat belts” on page 197.
- It is also possible to adjust the height of the front seats to obtain the best position for the front seat belts. ■

### Taking off the seat belts

The red button releases the belt from the buckle.



Fig. 213 The latch plate of the belt springs out of the buckle

- Press the red button in the seat belt buckle ⇒ fig. 213. The latch plate will spring out of the buckle.
- Guide the belt back by hand so that it is taken up by the retractor. ■

### Belt tensioners

#### How the belt tensioners work

The seat belts for the driver and front passenger are equipped with belt tensioners.

The seat belts on the front seats are tensioned automatically in frontal, side and rear-end impacts above a certain degree of severity. This helps to reduce the forward motion of the occupants.

In a less severe accident, or in the event of a roll-over, the belt tensioners are not activated. ▶

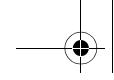

**WARNING**

- Any work on the tensioner system or removal and installation of system components for other repairs must be performed by a qualified workshop.
- The belt tensioners can only be activated once. If they have been activated at any time, the system must be replaced.



**Note**

- Some smoke may be released when the belt tensioners are activated. This does not mean there is a fire in the vehicle.
- The relevant safety requirements must be observed when the vehicle or components of the system are scrapped. Your authorised Audi dealer is familiar with these regulations and will be pleased to pass on the information to you. ■

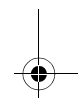
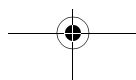
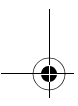
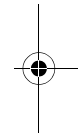
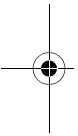

## Airbag system

### Description of airbag system

#### General notes on airbag system

*The airbag is an integral part of the car's passive safety system.*

In conjunction with the three-point seat belts, the airbag system gives the front occupants additional protection for the head and chest in the event of a severe frontal collision.

In a severe side collision the side airbags and the head-protection airbags reduce the risk of injury to the occupants in the areas of the body facing the impact ⇒ .

In addition to their normal function of protecting the occupants in a collision, the seat belts also hold them in a position where the airbags can inflate properly and provide maximum protection.

The airbag system will only work with the ignition on. The airbag system is monitored electronically; the airbag warning lamp indicates whether the system is functioning properly.

#### The main parts of the airbag system are:

- the electronic monitoring system (control unit and sensors),
- the two front airbags,
- the front side airbags, the side airbags on the outer rear seats\* and the head-protection airbags,
- the airbag warning lamp in the instrument cluster.

#### There is a fault in the airbag system if the warning lamp

- does not come on when the ignition is switched on,
- does not go out about 4 seconds after the ignition is switched on,

- goes out and then comes on again after the ignition is switched on,
- comes on or flickers while the car is moving.

#### WARNING

- **The airbags are not a substitute for the seat belts; they are an integral part of the car's overall passive safety system. The airbags can only offer effective protection if the occupants are wearing their seat belts. For this reason it is very important to wear the seat belts at all times ⇒ page 194, "Why is it so important to use seat belts?".**
- **The seat belts and airbags can only provide maximum protection if the occupants are seated correctly ⇒ page 73, "Seats and storage".**
- **If you do not wear a seat belt, if you lean forward, or are not seated correctly while the vehicle is in motion, you are at greater risk of injury should the airbag system be triggered in an accident.**
- **Components of the airbag system are located in various parts of the vehicle. If repairs to other vehicle components make it necessary to perform work on the airbag system or to remove or install parts of the airbag system, this may cause damage to the airbag system. As a result, the airbags may not inflate correctly or may not be triggered at all in an accident situation. For this reason, you should always have the work carried out by a qualified workshop.**
- **If a fault should occur in the airbag system, have the system checked immediately by a qualified workshop. Otherwise the system may fail to trigger in an accident.**
- **Do not attempt to modify components of the airbag system in any way.**
- **Never make any alterations to the front bumper or the body.**

**⚠ WARNING (continued)**

- **Do not remove the front seats.**
- **The airbag system can only be activated once; if the airbag has been triggered, the system must be replaced. Should the airbag system or airbag modules have to be replaced, the qualified workshop carrying out the replacement will document all details in the appropriate section of the Service Schedule.**
- **If you sell the vehicle, please remember to pass on the complete Service Wallet to the new owner. If any of the airbags have been deactivated, it is important that the new owner is also given the relevant documents.**
- **The relevant safety requirements must be observed when the vehicle or components of the airbag or belt tensioner systems are scrapped.**
- **In an accident in which one or more airbags are triggered the alternator and the starter are - for safety reasons - both disconnected from the battery via a pyrotechnic circuit breaker.**
  - Any repairs to the pyrotechnic circuit breaker must always be performed by a qualified workshop (accident risk).
  - The relevant safety requirements must be observed when the vehicle or the circuit breaker are scrapped. ■

**When are the airbags triggered?**

*The airbag system is triggered in collisions with a severe impact.*

The airbag system is designed so that the airbags for the driver and front passenger are triggered in a severe **frontal collision**.

In **severe side collisions** the side airbags on the impact side of the vehicle are triggered together with the head-protection airbag.

The front airbags, side airbags and one of the head-protection airbags may be triggered together in certain types of accident.

The airbag system is **not triggered** in **minor** frontal or side collisions, or in rear collisions or if the car overturns. In these situations the occupants are protected by wearing the seat belts.

**Factors determining the triggering response**

It is not possible to define the exact triggering response of the airbag system in all possible situations, since the circumstances in different types of accident will vary considerably. Important factors include, for example, the nature (hard or soft) of the object which the car hits, the angle of impact, vehicle speed and so on.

Whether the airbags are triggered depends primarily on the vehicle deceleration rate resulting from the collision. By processing the signals from the sensors located in the vehicle, the electronic control unit is immediately able to evaluate the severity of the collision and activate the restraint systems accordingly. If the deceleration rate is below the predefined reference value in the control unit the airbags will not be triggered, even though the accident may cause extensive damage to the car.

**i Note**

The airbag releases a fine dust when it inflates. This is quite normal and does not mean there is a fire in the vehicle. ■

## Front airbags

### Description of front airbags

The airbag system is not a substitute for the seat belts.



Fig. 214 Driver's airbag in steering wheel

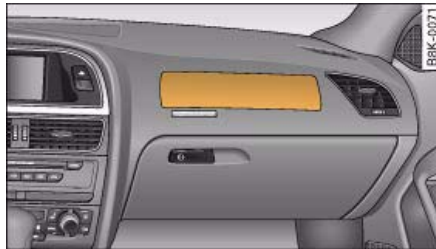

Fig. 215 Front passenger's airbag in dashboard

The front airbag for the driver is located in the padded hub of the steering wheel ⇒ fig. 214. The front airbag for the front passenger is in the dashboard above the glove box ⇒ fig. 215. The locations of the airbags are marked with the word "AIRBAG".

In conjunction with the three-point seat belts, the front airbags give additional head and chest protection for the driver and front passenger in the event of a severe frontal collision ⇒ ⚠ in "Important safety notes on the front airbag system" on page 204. ■

### How the front airbags work

When fully inflated, the airbags reduce the risk of head or chest injury.



Fig. 216 Front airbags in inflated condition

The airbag system is designed so that the airbags for the driver and front passenger are triggered in a severe frontal collision.

In certain types of accident the front airbags, side airbags and one of the head-protection airbags may be triggered together.

When the system is triggered, the airbags fill with a propellant gas and open out in front of the driver and front passenger ⇒ fig. 216. In order to provide the desired extra protection in an accident, the airbags have to inflate extremely rapidly (within fractions of a second). The fully deployed airbags cushion the forwards movement of the front occupants and help to reduce the risk of injury to the head and the upper part of the body.

Special openings in the airbag allow the gas to escape at a controlled rate to restrain the forward movement of the occupant's head and torso. Once the impact has been absorbed, the airbag deflates sufficiently for the front occupants to see forward. ■

### Important safety notes on the front airbag system

There are a number of safety points concerning the airbag system which you should remember. This will help to reduce the risk of injury in an accident.

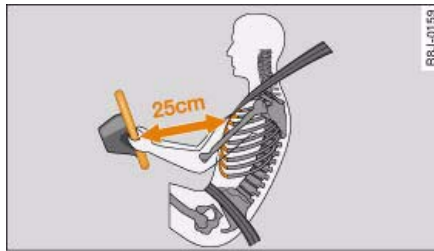

Fig. 217 Minimum distance from steering wheel

#### **! WARNING**

- It is important for the driver and front passenger to maintain a distance of at least 25 cm from the steering wheel or dashboard ⇒ fig. 217. The airbag system will not be able to give the required protection if you sit too close to the steering wheel or dashboard. There is also a risk of injury if the airbags are inflated. The front seats and head restraints must always be positioned correctly for the height of the occupant.
- If you do not wear a seat belt, if you lean forward or to the side, or are not seated correctly while the vehicle is in motion, you are at greater risk of injury. Should the airbag system be triggered in an accident there is an even greater risk of injury.
- Never let a child travel on the front seat without an appropriate restraint system. If the airbag is triggered in an accident, the child could sustain serious or fatal injuries ⇒ page 210, "Child safety".
- Never install a rearward-facing child safety seat on the front passenger's seat unless the front passenger's airbag has been

#### **! WARNING (continued)**

deactivated. However, if you have no alternative but to use a rearward-facing child seat on the front passenger's seat, the front passenger's airbag must be deactivated beforehand by means of the key-operated switch\* ⇒ page 208. Failure to observe this precaution could result in serious or potentially fatal injury.

- Occupants sitting in the front of the car must never carry any objects or pets in the space between them and the airbags, or allow children or other passengers to travel in this position.
- Do not cover or stick anything on the steering wheel hub or the soft plastic surface of the airbag unit on the passenger's side of the dashboard, and do not obstruct or modify them in any way. These parts should only be cleaned with a dry cloth (or with a cloth moistened with plain water). It is also important not to attach any objects such as cup holders or telephone mountings to the surfaces covering the airbag units.
- Any work on the airbag system or removal and installation of the airbag components for other repairs (such as repairs to the steering wheel or removal of seats) must be performed by a qualified workshop.

#### **i Note**

If necessary, you can deactivate the front passenger's airbag by means of the key-operated switch\* ⇒ page 208. ■

## Side airbags

### Description of side airbags

The airbag system is not a substitute for the seat belts.

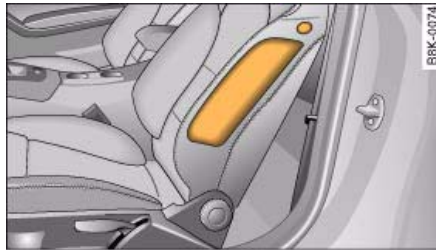

Fig. 218 Location of side airbag in driver's seat

The side airbags are located in the backrest padding of the front seats ⇒ fig. 218. The locations of the airbags are marked with the word "AIRBAG".

In conjunction with the three-point seat belts, the side airbags give the occupants additional protection for the whole upper part of the body (i.e. the chest, stomach and pelvis) in the event of a severe side collision ⇒ ⚠ in "Important safety notes on the side airbag system" on page 206.

In a side collision the side airbags reduce the risk of injury to the areas of the body facing the impact.

If the side airbags are activated, the head-protection airbags (side-guard system) are always triggered at the same time for additional protection on the side of the vehicle facing the impact ⇒ page 207. ■

### How the side airbags work

When fully inflated, the side airbags reduce the risk of injuries to the upper part of the body.

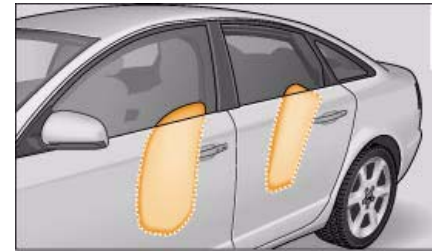

Fig. 219 Side airbags in inflated condition

In certain types of **side collisions** the side airbags (front and rear\*) are triggered on the impact side of the vehicle ⇒ fig. 219.

The front airbags, side airbags and the head-protection airbag may be triggered together in certain types of accident.

When the system is triggered, the airbag is filled with propellant gas.

In order to provide the desired extra protection in an accident, the airbags have to inflate extremely rapidly (within fractions of a second). The airbag releases a fine dust when it inflates. This is quite normal and does not mean there is a fire in the vehicle.

When fully deployed, the airbags cushion the impact for the occupants and help to reduce the risk of injury to the whole upper part of the body (i.e. the chest, stomach and pelvis) on the side facing the door. ■

### Important safety notes on the side airbag system

*There are a number of safety points concerning the airbag system which you should remember. This will help to reduce the risk of injury in an accident.*

#### WARNING

- If you do not wear a seat belt, if you lean forward, or are not seated correctly while the vehicle is in motion, you are at greater risk of injury should the side airbags on the front seats or the outer rear seats\* be triggered in an accident. This applies particularly to children if they are not properly protected by a child restraint system ⇒ *page 212, "Important notes on side airbags and child safety"*.
- If children are not seated correctly, they are at greater risk of injury in an accident. This is particularly the case if the child is travelling on the front passenger's seat and the airbag system is triggered. This could result in serious or potentially fatal injury ⇒ *page 210, "Child safety"*.
- It is also important not to attach any accessories (such as cup holders) to the doors. This would impair the protection offered by the side airbags (front and rear\*).
- The sensors for the airbags are located in the front doors. You must therefore not make any modifications to the doors or door trim (e.g. retrofitting loudspeakers), as this could impair the function of the side airbags. Any damage to the front doors could lead to faults in the system. Repairs or any other work on the front doors must therefore always be carried out by a qualified workshop.
- The built-in coat hooks should only be used for lightweight clothing. Do not leave any heavy or sharp-edged objects in the pockets.

#### WARNING (continued)

- Do not apply excessive force to the sides of the backrests (such as hard knocks or kicks), as this could damage parts of the system. The side airbags could then fail to operate when required.
- If you intend to fit protective covers over the seats, these must be of the specific type approved for use on Audi seats with side airbags. Conventional seat covers would obstruct the side airbag when it inflates out of the backrest, and seriously reduce the airbag's effectiveness.
- Any damage to the original seat upholstery or around the seams of the side airbag units must be repaired immediately by a qualified workshop.
- Any work involving the side airbag system or removal and installation of the airbag components for other repairs (such as repairs to the seats) must always be performed by a qualified workshop. Otherwise the airbag system may fail to work properly. ■



## Head-protection airbags (sideguard)

### Description of head-protection airbags

The head-protection airbags work together with the side airbag system to give extra protection in a side impact.



Fig. 220 Location of head-protection airbags above the doors

The head-protection airbags are located above the doors on the left and right sides of the vehicle ⇒ page 207, fig. 220. The locations of the airbags are marked with the word "AIRBAG".

In conjunction with the three-point seat belts and side airbags, the head-protection airbags give the occupants additional protection against head and neck injuries in a severe side collision ⇒ ⚠ in "Important safety notes on the head-protection airbags" on page 208.

Together with other design features (including cross-braces in the seats and the overall strength of the body structure), the sideguard system offers an effective further improvement to occupant protection in side impacts. ■

### How the head-protection airbags work

When fully inflated, the airbags reduce the risk of head or chest injury in a side collision.



Fig. 221 Head-protection airbags in inflated condition

In certain types of **side collisions** the head-protection airbag is triggered together with the side airbag on the impact side of the vehicle ⇒ fig. 221.

When the system is triggered, the airbag fills with a propellant gas and covers the entire area in front of the side windows, including the door pillars. In this way the system is able to protect both the front and the rear occupants on the side of the vehicle where the impact occurs. The head-protection airbag inflates to soften the impact if an occupant strikes parts of the interior or objects outside the vehicle with their head. By reducing the head impact and restraining uncontrolled movement of the head, the airbag also reduces the forces acting on the neck. In addition, since it covers the front door pillar when fully inflated, the head-protection airbag also gives extra protection if the car should collide with an obstacle at an oblique angle.

The front airbags, side airbags and head-protection airbags may be triggered together in certain types of accident.

In order to provide the desired extra protection in an accident, the airbags have to inflate extremely rapidly (within fractions of a ▶

second). The airbag releases a fine dust when it inflates. This is quite normal and does not mean there is a fire in the vehicle. ■

### Important safety notes on the head-protection airbags

*There are a number of safety points concerning the airbag system which you should remember. This will help to reduce the risk of injury in an accident.*

#### **! WARNING**

- It is important to ensure that the area around the openings for the head-protection airbags remains unobstructed at all times, so that the airbags can inflate properly if needed.
- The built-in coat hooks should only be used for lightweight clothing. Do not leave any heavy or sharp-edged objects in the pockets. When using the coat hooks, do not hang the clothes on coat hangers.
- The space between the passengers and the head-protection airbags must never be occupied by children, other passengers or pets. Passengers should never lean out or put a hand or arm out of the window while the vehicle is in motion.
- Do not move the sun visors out to cover the side windows if there is anything attached to them (such as pens or a remote control for the garage door). These objects could cause injury if the head-protection airbag is triggered.
- The sensors for the airbags are located in the front doors. You must therefore not make any modifications to the doors or door trim (e.g. retrofitting loudspeakers), as this could impair the function of the side airbags. Any damage to the front doors could lead to faults in the system. Repairs or any other work on the front doors must therefore always be carried out by a qualified workshop.

#### **! WARNING (continued)**

- Where sun blinds are fitted on the rear doors, these must not obstruct or impair the airbags in any way.
- If unsuitable accessories are installed near the head-protection airbag, the protection afforded by the airbag can be seriously impaired if the system is triggered. When the head-protection airbag opens, parts of these accessories could be thrown into the vehicle and injure passengers ⇒ *page 277*.
- Any work involving the head-protection airbags, or removal and installation of the airbag components for other repairs (such as repairs to the roof liner), must always be performed by a qualified workshop. Otherwise the airbag system may fail to work properly. ■

Applies to vehicles: with key-operated switch for front passenger's airbag

### Deactivating the front passenger's airbag via the key-operated switch

*If an airbag has been deactivated, it should be reactivated as soon as possible so that it can continue to give the required protection.*



Fig. 222 Key-operated switch in glove box for deactivating front passenger's airbag ▶



Fig. 223 Lamp indicates that front passenger's airbag has been deactivated via key-operated switch

The key-operated switch for deactivating the front passenger's airbag is located in the glove box ⇒ fig. 222.

- To deactivate the front passenger's airbag, insert the ignition key into the switch and turn it to position **OFF**.
- The front passenger's airbag can be reactivated by turning the key to position **ON**.

#### Deactivating front passenger's airbag when a child safety seat is in use

If you have no alternative but to install a rearward-facing child safety seat on the front passenger's seat you must deactivate the front passenger's airbag beforehand.

We recommend, however, that child seats should be only fitted on the rear seat so that the front passenger's airbag can remain functional and provide protection in an accident ⇒ page 210.

#### Monitoring of airbag system

The airbag warning lamp will light up for a few seconds every time the ignition is switched on.

If the front passenger's airbag has been deactivated via the key-operated switch, the indicator lamp "PASSENGER AIRBAG OFF" will light up constantly as a reminder ⇒ page 209, fig. 223. Please refer also to the description of the  warning lamp in the instrument cluster ⇒ page 17.

When the front passenger's airbag is deactivated using the key-operated switch, the seat belt warning lamp for the front passenger  ⇒ page 18 is also switched off.

#### WARNING

- If you have no alternative but to install a rearward-facing child seat on the front passenger's seat, the front passenger's airbag must be deactivated beforehand. Potentially fatal injuries to the child can result if the front passenger's airbag is not deactivated! ⇒ page 211, "Using a child safety seat on the front passenger's seat"
- If you have deactivated the front passenger's airbag, reactivate it as soon as the child seat is no longer needed so that the airbag can continue to give the required protection.
- It is the driver's responsibility to ensure that the key-operated switch is set to the correct position.

#### Note

All the other airbags in the car will remain functional if the front passenger's airbag has been deactivated with the key-operated switch. ■

## Child safety

### Points to remember if children are travelling in the car

#### Introduction

*Statistics show that children are generally safer on the rear seat than on the front passenger's seat.*

Children under 12 years of age should normally travel on the rear seat <sup>2)</sup>. Children travelling on the rear seat must use a child restraint system or the seat belts provided, depending on their age, height and weight. For safety reasons, the child restraint system should be installed behind the front passenger's seat.

The physical principles involved and the forces acting in a collision apply to children just as much as adults ⇒ *page 195*, "Forces acting in a collision". But, unlike adults, children do not have fully developed muscle and bone structures. This means that children are subject to a greater risk of injury.

To reduce this risk, children must always use special child restraint systems when travelling in the car.

Use only child restraint systems which are officially approved under the European standard ECE R 44 and are suitable for the child. ECE R refers to the Economic Commission of Europe Recommendation, which categorises child restraint systems in 5 groups ⇒ *page 213*, "Child seat categories". Child restraints that have been tested and approved under the ECE R 44 standard bear the ECE-R 44 test mark on the seat (the letter E in a circle with the test number below it).

We recommend using child restraint systems from the range of Audi Genuine Accessories available from Audi dealers. The "Huckepack" range includes suitable restraint systems for all ages.

<sup>2)</sup> Observe any restrictions or regulations to the contrary.

These systems have been specially developed and tested for use in Audi vehicles and comply with the ECE-R 44 standard.

Follow the manufacturer's instructions and observe any statutory requirements when installing and using child restraints ⇒ ⚠ in "Important safety notes for using child safety seats". ■

#### Important safety notes for using child safety seats

*Correct use of child safety seats can help to reduce the risk of injury in an accident.*

#### ⚠ WARNING

- All vehicle occupants, especially children, must wear a seat belt while the vehicle is in motion.
- Children who are less than 1.5 metres tall must not wear a normal seat belt without a child restraint, as this could cause injuries to the abdominal and neck areas.
- Babies and children must never travel on another occupant's lap.
- A suitable child safety seat can protect your child ⇒ *page 213*, "Child safety seats".
- Never allow two children to occupy one child safety seat.
- Never leave a child without supervision in a child safety seat.
- Never allow a child to travel in the car without a suitable child restraint.
- Never allow a child to stand up or kneel on a seat while the car is moving. In an accident, the child could be catapulted through the car, causing possibly fatal injuries to itself and other occupants.

**⚠ WARNING (continued)**

- If children lean forward or are otherwise out of position when the car is moving, they are at greater risk of injury in an accident. This is particularly the case if the child is travelling on the front passenger's seat and the airbag system is triggered in an accident. There is then a risk of serious or potentially fatal injury.
- To ensure proper protection, it is important to wear the seat belts in the correct position ⇒ *page 197*, "How to wear seat belts properly". Always check that the belt is properly positioned according to the instructions provided by the manufacturer of the child safety seat. Incorrectly worn seat belts can give rise to injuries even in a minor collision.
- Never install a rearward-facing child safety seat on the front passenger's seat if the front passenger's airbag has not been deactivated ⇒ *page 211*.
- Extra caution is advised if you are installing a child safety seat using the same mounting bolts as the existing car seat belts. The bolts must be screwed in all the way to the full depth of the mounting holes and tightened to a torque of 50 Nm. Failure to observe this precaution could result in potentially fatal injury. We recommend having the installation performed by a qualified workshop. ■

**⚠ WARNING**

- Do not use a rearward-facing child safety seat on the front passenger's seat unless the front passenger's airbag has been deactivated. The child seat would be directly in the path of the airbag as it inflates, and the child could sustain serious or fatal injuries if the airbag were to be deployed.
- However, if you have no alternative but to use a rearward-facing child seat on the front passenger's seat, the front passenger's airbag must be deactivated beforehand by means of the key-operated switch\* ⇒ *page 208*. Failure to observe this precaution could result in serious or potentially fatal injury.
- Make sure that the front passenger's airbag is reactivated by means of the key-operated switch\* as soon as the child seat is no longer needed on the front passenger's seat.
- When using a child safety seat of the type which faces in the direction of travel, the front passenger's seat must be moved back to the rearmost position. ■

**Using a child safety seat on the front passenger's seat**

*Whenever possible, child safety seats should always be installed on the rear seat.*

For safety reasons, we recommend that child safety seats should be installed on the rear seats whenever possible. However, if you have to use a child seat on the front passenger's seat when there is **no other alternative**, it is most important to note the following warnings:

Controls

Safety

Driving tips

General maintenance

Self-help

Technical data

Applies to vehicles: with side airbags

### Important notes on side airbags and child safety

*Children must never sit too close to the opening for the side airbag.*



**Fig. 224** Not properly restrained, and too close to the opening for the side airbag



**Fig. 225** Correctly seated in a suitable child safety seat

The side airbags offer increased protection in a side-on collision. In order to be effective, the side airbags need to inflate very quickly (within fractions of a second) ⇒ *page 205*, "How the side airbags work".

The airbag inflates with such force that injury can be caused if the occupant is not sitting upright, or if there are any objects close to the opening for the side airbag.

**This applies particularly to children if they are travelling in a way which does not comply with the statutory safety regulations.**

#### Incorrect position – danger of injury from the side airbag

If the side airbag were to inflate in an accident, it would strike the child on the head and most likely cause serious injury ⇒ *fig. 224*.

#### Correct position – properly restrained in a suitable child safety seat

The child is correctly seated in a suitable child restraint system on the rear seat ⇒ *fig. 225*. There is enough space between the child and the opening for the side airbag.

In an accident, the airbag would be able to inflate completely to offer maximum protection.

#### **WARNING**

**To help prevent serious injury, children travelling in the vehicle must always be protected with a restraint system which is suited to their age, height and weight.**

- **The child's head must always be well away from the opening for the side airbag. There is a risk of suffering injury.**
- **Do not leave or place any objects in the space next to the side airbag. There is a risk of suffering injury.**

#### **Note**

If required, you can have the side airbags for the rear passengers deactivated by a qualified workshop. ■

## Child safety seats

### Child seat categories

Only use child restraint systems that are officially approved and suitable for the child.

Child restraint systems are covered by the European standard ECE R 44 (issued by the Economic Commission of Europe).

The child seats are divided into 5 categories:

Category	Weight	
0	0 - 10 kg	⇒ page 213
0+	up to 13 kg	⇒ page 213
1	9 - 18 kg	⇒ page 214
2	15 - 25 kg	⇒ page 214
3	22 - 36 kg	⇒ page 214

Children who are taller than 1.5 metres can use the existing seat belts without a booster cushion.

Child restraints that have been tested and approved under the ECE R 44 standard bear the ECE-R 44 test mark on the seat (the letter E in a circle with the test number below it). ■

### Child safety seat: category 0 / 0+

A suitable child safety seat and a correctly worn seat belt can protect your child.

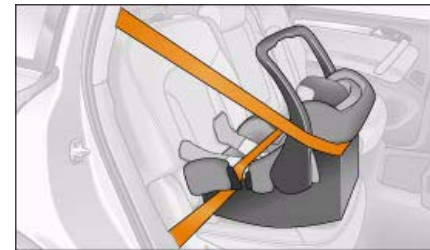

Fig. 226 Child safety seat: Category 0 / 0+

Babies up to about 9 months old / 10 kg and infants up to about 18 months old / 13 kg are best protected by child safety seats that can be adjusted to a horizontal position ⇒ fig. 226.

Follow the manufacturer's instructions and observe any statutory requirements when installing and using child restraints ⇒ page 210, "Important safety notes for using child safety seats".

#### WARNING

Never install a rearward-facing child safety seat on the front passenger's seat if the front passenger's airbag has not been deactivated ⇒ page 211. This can result in serious or possibly fatal injury. ■

### Child safety seats: category 1

A suitable child safety seat and a correctly worn seat belt can protect your child.



Fig. 227 A category 1 forward-facing child seat fitted on the rear seat

Babies and small children up to about 4 years of age weighing between 9 and 18 kg are best protected by child safety seats of the type where the child faces the front of the vehicle ⇒ fig. 227.

Follow the manufacturer's instructions and observe any statutory requirements when installing and using child restraints ⇒ page 210, "Important safety notes for using child safety seats".

**! WARNING**

Never install a rearward-facing child safety seat on the front passenger's seat if the front passenger's airbag has not been deactivated ⇒ page 211. This can result in serious or possibly fatal injury. ■

### Child safety seats: category 2/3

A suitable child safety seat and a correctly worn seat belt can protect your child.



Fig. 228 A category 2/3 forward-facing child seat (with backrest) fitted on the rear seat



Fig. 229 A category 2/3 forward-facing child seat (without backrest) fitted on the rear seat

Children up to about 12 years of age weighing between 15 and 36 kg but less than 1.5 metres tall are best protected by a child safety seat in conjunction with the three-point seat belts ⇒ fig. 228 and ⇒ fig. 229.

Follow the manufacturer's instructions and observe any statutory requirements when installing and using child restraints ⇒ page 210, "Important safety notes for using child safety seats". ▶





 **WARNING**

The diagonal part of the belt should be positioned roughly over the centre of the shoulder and fit closely against the upper part of the body. It must never be allowed to run across the neck. The lap part of the belt should fit closely over the hips. It must not be positioned over the stomach. Pull the belt tight if necessary to take up any slack.

 **Note**

We recommend that you fit child safety seats with backrests. ■

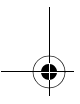
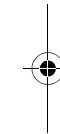
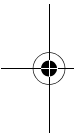

## Fitting child safety seats

### General information



Fig. 230 Example of an approval number on a child safety seat

Label on a child safety seat ⇒ fig. 230

- ① Approval number
- ② Manufacturer's serial number.

The label also shows information on the use and weight class of the child seat.

### List of recommended child restraint systems

Weight class	Identification "Huckepack"	Audi Genuine accessories catalogue number	Manufacturer	Model	Approval number
0+ (up to 13 kg)	G0 Plus	00A.019.900.A	Britax Römer	Baby Safe Plus	E1 03301146
1 (9 to 18 kg)	G1 ISOFIX Duo Plus	00A.019.909.B	Britax Römer	Duo Plus	E1 03301133
2 (15 to 25 kg)	1)	1)	1)	1)	1)
3 (22 to 36 kg)	1)	1)	1)	1)	1)

1) Under development.

For the current range of child seats from Audi Genuine Accessories visit: <http://www.audi.com>

## Extended list of recommended child restraint systems

Weight class	Identification	Catalogue number	Manufacturer	Model / Mode of securing seat	Approval number
0 - 1 (up to 18 kg)	ISOFIX RWF	4590.xx, 4710.xx <sup>1)</sup>	FAIR	FAIR G0/ 1 rearward-facing with vehicle-specific platform type A (RWF)	E4 04443513
1 (9 to 18 kg)	ISOFIX FWF	4590.xx, 4610.xx <sup>1)</sup>	FAIR	FAIR G0/ 1 forward-facing with vehicle-specific platform type A (FWF)	E4 04443513
	Universal	4590.xx <sup>1)</sup>	FAIR	FAIR G0/ 1 standard three-point seat belt <sup>2)</sup>	E4 03443416

<sup>1)</sup>manufacturer details:

**Company: FAIR srl**

Address: Strada della Cisa 249/251, I- 42040 Sorbolo Levante di Brescello (RE) / Italy.

<http://www.fairbimbofix.com>

<sup>2)</sup> may also be secured with two-point seat belt. ■

Controls

Safety

Driving tips

General maintenance

Self-help

Technical data

### Possible alternatives for securing a child safety seat

A child safety seat can be secured on the rear seats and on the front passenger's seat.

The following alternatives are available for safely securing a child safety seat on the rear seats and on the front passenger's seat.

- Child safety seats of the categories **0 to 3** can be secured with the standard three-point seat belts.
- Child safety seats of the categories **0, 0+ and 1** with the "ISOFIX" system can be secured without seat belts using the "ISOFIX" retainers\* ⇒ page 218.

**Compatibility of vehicle seat positions for child safety seats (according to EC directive 77/541):**

Weight class	Front passenger's seat	Rear seats
<b>0, 0+</b>	u, a, b, c	u, d
<b>1</b>	u, a, b, c	u, d
<b>2</b>	u, a	u
<b>3</b>	u, a	u

- u** "universally compatible"
- a** The front passenger's *backrest* must be set as far forward as possible or adapted to the child safety seat as required, and the seat height must be adjusted to its highest position.
- b** The front passenger's airbag must be deactivated if a rearward-facing child seat is used.
- c** The front passenger's seat can be equipped with optional "ISOFIX" retainers.
- d** The rear seats can be equipped with optional "ISOFIX" retainers.

### WARNING

While the vehicle is moving, children must always be protected with a restraint system which is suited to their age, height and weight. Please refer to the chapter "Child seat categories".

- **Never install a rearward-facing child safety seat on the front passenger's seat unless the front passenger's airbag has been deactivated. This could result in potentially fatal injuries. If you have no alternative but to let a child travel on the front passenger's seat, the front passenger's airbag must be deactivated beforehand. Please refer to the chapter "Deactivating airbags".**
- **Note the important information and warnings concerning the use of child safety seats found in the chapter "Important safety notes when using child safety seats" and in the installation instructions provided by the manufacturer of the child safety seat. ■**

Applies to vehicles: with ISOFIX system

### "ISOFIX" child seat mounting system

Child safety seats with the "ISOFIX" system can be secured quickly and easily.

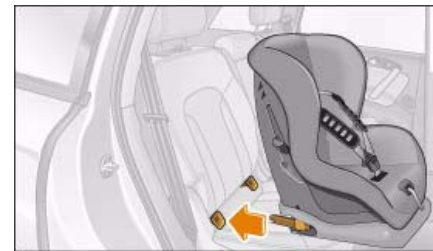

Fig. 231 The ISOFIX child safety seat is pushed into the protective sleeves.

When removing or fitting the child safety seat, please be sure to follow the manufacturer's instructions. ▶



- Fit the protective sleeves **(A)** onto the retainers **(B)** between the backrest and the seat cushion ⇒ *page 218*, fig. 231.
- Push the mountings on the child safety seat into the protective sleeves until they engage audibly (2x) ⇒ *page 218*, fig. 231.
- Pull on the child safety seat to check whether **both** catches have engaged properly.

Child safety seats with the "ISOFIX" system can be secured quickly and safely on the rear seat\* or on the front passenger's seat\*. Detailed fitting instructions are supplied with the child safety seat. Child seats with "ISOFIX" mountings are available from Audi dealers and specialist retailers.

If required, the "ISOFIX" mounting system can be retrofitted.

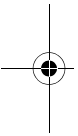

 **WARNING**

The retainers used here are specially designed for child safety seats with "ISOFIX" mountings. Do not attempt to secure other types of child safety seat, seat belts or other objects with these retainers – this could result in serious or possibly fatal injury. ■

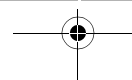
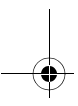
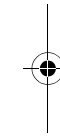

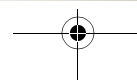
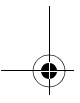
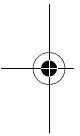

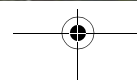
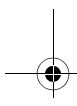
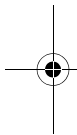



## Intelligent technology

### Electronic stabilisation program (ESP)

#### Description

ESP increases the car's stability. It reduces the tendency to skid and improves the stability and roadholding of the vehicle. ESP detects critical handling situations, such as understeer, oversteer and wheelspin on the driven wheels. It stabilises the vehicle by braking individual wheels or by reducing the engine torque. The warning lamp  in the instrument cluster starts flashing as soon as the ESP intervenes.

The ESP incorporates the functions of the anti-lock brake system (ABS), the traction control system (ASR), the electronic differential lock (EDL) and the dynamic steering\*.

#### Anti-lock brake system (ABS)

ABS prevents the wheels from locking up under braking until the vehicle has reached a virtual standstill. You can continue to steer the vehicle even when the brakes are on full. Keep your foot on the brake pedal and do not pump the brakes. You will feel the brake pedal pulsate while the anti-lock brake system is working.

#### Brake assist system

The brake assist system can speed up the braking process and shorten the braking distance. It automatically boosts the braking force if you press the brake pedal quickly in an emergency. On vehicles with adaptive cruise control\*, the brake assist system will build up a small amount of pressure in the hydraulic brake system if it senses that you are too close to the vehicle in front.

#### Traction control system (ASR)

In the event of wheelspin, the traction control system reduces the engine torque to match the amount of grip available. This helps the car to start moving, accelerate or climb a gradient.

#### Electronic differential lock (EDL)

When the EDL detects wheelspin, it brakes the spinning wheel and directs the power to the other driven wheel (or wheels on quattro\* versions). This function is active up to about 100 km/h.

To prevent the disc brake of the braked wheel from overheating, the EDL cuts out automatically if subjected to excessive loads. The vehicle can still be driven. The EDL will switch on again automatically when the brake has cooled down.

#### Dynamic steering\*

On vehicles with dynamic steering\*, the ESP can also intervene in the steering to stabilise the vehicle in critical situations.

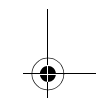
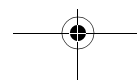
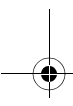
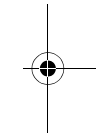
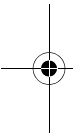

#### WARNING

- The grip provided by the ESP, ABS, ASR, EDL and dynamic steering\* systems is still subject to the physical limits of adhesion. Always bear this in mind, especially on wet or slippery roads. If you notice the systems cutting in, you should reduce your speed immediately to suit the road and traffic conditions. Do not let the extra safety provided tempt you into taking any risks when driving – this can cause accidents.
- Please remember that the accident risk always increases if you drive fast, especially in corners or on a slippery road, or if you follow too close behind the vehicle in front of you. Please bear in mind that even ESP, ABS, brake assist, EDL, ASR and dynamic steering\* cannot compensate for the increased accident risk.
- When accelerating on a uniformly slippery surface (for instance all four wheels on ice or snow), press the accelerator gradually and carefully. The driven wheels may otherwise start to spin (in spite of the integrated control systems), which would impair the car's stability and could lead to an accident.





### Note

- To ensure that the ASR works properly, all four wheels must be fitted with identical tyres. Any differences in the rolling radius of the tyres can cause the system to reduce engine power when this is not desired.
- Should a malfunction occur in the ABS or EDL, both the ABS warning lamp  and the ESP warning lamp  ⇒ *page 19* will light up.
- In the event of a malfunction in the ESP system, the warning lamp  ⇒ *page 17* will light up.
- If a malfunction should occur in the ABS, the ESP, EDL and ASR will also be out of action.
- The systems can make noises when they intervene. ■

### Switching on and off

*The ESP is switched on automatically when the engine is started.*



Fig. 232 Version A:  
Centre console  
(bottom), ESP OFF  
button



Fig. 233 Version B:  
Centre console (top),  
ESP OFF button

### Switching off the traction control system (ASR)

In particular circumstances, it may be advisable to switch off the traction control system (ASR) to allow a certain amount of wheel slip. For example:

- Rocking the car backwards and forwards to free it
- Driving in deep snow or on loose surfaces
- Driving with snow chains

Press the **[ESP OFF]** button briefly ⇒ fig. 232 or ⇒ fig. 233. The warning lamp  will light up and the message **ASR off** will appear in the driver information system display.

The traction control system (ASR) can only be switched off at speeds below 50 km/h on vehicles with front-wheel drive. At 70 km/h it will switch on again automatically. The ASR can be deactivated at any speed on vehicles with four-wheel drive.

### Switching off the ESP

Press the **[ESP OFF]** button for longer than 3 seconds. The ESP warning lamp  will light up and the message **ESP switched off** will appear in the display. The ASR is also deactivated when the ESP is switched off.

### Switching on

Press the **[ESP OFF]** button again. The message **ESP/ASR on** will appear briefly on the display. ▶

**WARNING**

You should switch off the ESP only if your driving ability and traffic conditions allow you to do so safely. Please note that, when the ASR and ESP are switched off, the driven wheels may start to spin, causing the vehicle to lose grip, in particular on slippery or wet roads - danger of skidding!

**Note**

The ASR and ESP cannot be switched off when the adaptive cruise control (ACC)\* is on. ■

**Brakes****New brake pads**

New brake pads do not give full braking effect for the first 400 km, they must first be "bedded in". However, you can compensate for the slightly reduced braking effect by applying more pressure on the brake pedal. Avoid placing a heavy load on the brakes during the running-in period.

**Wear**

The rate of wear on the **brake pads** depends a great deal on how you drive and the conditions in which the vehicle is operated. Negative factors are, for instance, city traffic, frequent short trips or hard driving with abrupt starts and stops.

**Wet roads; road salt**

When you are driving at a speed *higher than 80 km/h* and have the windscreen wipers *switched on* the brake pads are very briefly brought into contact with the brake discs. This automatic process which goes unnoticed by the driver is carried out at regular intervals and is intended to improve braking response in wet conditions.

In certain conditions, such as in heavy rain, or after washing the car or driving through water, the full braking effect can be delayed by moisture (or in winter by ice) on the discs and brake pads. The brakes should be "dried" by pressing the pedal to restore full braking effect.

The effectiveness of the brakes can also be temporarily reduced if the car is driven for some distance without using the brakes when there is a lot of salt on the road in winter. The layer of salt that accumulates on the discs and pads can be removed with a few cautious brake applications.

**Corrosion**

There may be a tendency for dirt to build up on the brake pads and corrosion to form on the discs if the car is used infrequently, or if you only drive low mileages without using the brakes very much.

If the brakes are not used frequently, or if corrosion has formed on the discs, it is advisable to clean off the pads and discs by braking firmly a few times from a moderately high speed ⇒ ⚠.

**Faults in the brake system**

If the brake pedal travel should ever increase *suddenly*, this may mean that one of the two brake circuits has failed. Drive immediately to the nearest qualified workshop and have the fault rectified. On the way to the dealer, be prepared to use more pressure on the brake pedal and allow for longer stopping distances.

**Low brake fluid level**

Malfunctions can occur in the brake system if the brake fluid level is too low. The brake fluid level is monitored electronically.

**Brake servo**

The brake servo amplifies the pressure you apply to the brake pedal. It only works when the engine is running. ►

**WARNING**

- **When applying the brakes to clean off deposits on the pads and discs, select a clear, dry road. Be sure not to inconvenience or endanger other road users; do not risk an accident.**
- **Never let the car coast with the engine switched off (this can cause accidents).**

**Caution**

- Never let the brakes “drag” by leaving your foot on the pedal when you do not really intend to brake. This overheats the brakes, resulting in longer stopping distances and greater wear.
- Before driving down a long, steep gradient, it is advisable to reduce speed and move the selector lever to a lower gear. In this way you will make use of the engine braking effect and relieve the load on the brakes. If you still have to use the brakes, it is better to brake firmly at intervals than to apply the brakes continuously.

**Note**

- If the brake servo is out of action due to a malfunction, or if the car has to be towed, you will have to press the brake pedal considerably harder to make up for the lack of servo assistance.
- If you wish to equip the car with accessories such as a front spoiler or wheel covers, it is important that the flow of air to the front wheels is not obstructed, otherwise the brakes can overheat. ■

**Power steering (servotronic)**

*The power steering assists the driver when turning the steering wheel (with the engine running).*

The power steering assists the driver by reducing the force needed to turn the steering wheel. The degree of power assistance is adapted *electronically*, depending on the speed.

If a fault should occur in the *servotronic* system the *power steering* will still operate. The degree of power assistance will, however, no longer adapt to different speeds. If the electronic regulating system is not working properly, this is most noticeable when turning the steering wheel at low speeds (for instance when parking) – more effort will be required than usual. The fault should be corrected by a qualified workshop as soon as possible.

The power steering does not function when the engine is switched off. In this case the steering wheel is very hard to turn.

If the steering is held at its *turning limit* when the car is stationary, this will place an excessive load on the power steering system. In this case, the power steering system will make noises. It will also reduce the idling speed of the engine.

**Caution**

Do not keep the steering in the full-lock position for longer than 15 seconds when the engine is running – this could cause damage to the power steering system.

**Note**

- If the power steering should fail at any time or the engine is switched off (for instance when being towed), the car can still be steered. However, more effort will be required to turn the steering wheel.
- If the system is leaking or malfunctioning, please take the car to a qualified workshop as soon as possible.
- The power steering requires a special hydraulic fluid. The fluid reservoir is located at the front of the engine compartment on the left ⇒ *page 256*. The correct fluid level in the reservoir is important for the power steering to function properly. The hydraulic fluid level is checked at the Inspection Service. ■



Applies to vehicles: with four-wheel drive

## Four-wheel drive (quattro®)

*On quattro models the engine power is distributed to all four wheels*

### General notes

On four-wheel drive vehicles, the engine power is distributed to all four wheels. The distribution of power is controlled automatically according to your driving style and the road conditions. Also refer to ⇒ page 222, "Description".

The four-wheel drive is specially designed to complement the superior engine power of your Audi. This combination gives the car exceptional handling and performance capabilities – both on normal roads and in more difficult conditions, such as snow and ice. Even so (or perhaps especially for this reason), it is important to observe certain safety points ⇒ .

### Winter tyres

Thanks to its four-wheel drive, your car will have plenty of *traction* in winter conditions, even with the standard tyres. Nevertheless, we still recommend that winter tyres or all-season tyres should be fitted *on all four wheels* when winter road conditions are expected, mainly because this will give a better *braking response*.

### Snow chains

On roads where snow chains are mandatory, this also applies to cars with four-wheel drive ⇒ page 273, "Snow chains".

### Replacing tyres

On vehicles with four-wheel drive, all four tyres must have the same rolling circumference. Also avoid using tyres with varying tread depths ⇒ page 270, "Replacing wheels and tyres".

### Off-roader?

Your Audi does not have enough ground clearance to be used as an off-road vehicle. It is therefore best to avoid rough tracks and uneven terrain as much as possible.

### WARNING

- **Even with four-wheel drive, you should always adjust your speed to suit the conditions. Do not let the extra safety provided tempt you into taking any risks when driving – this can cause accidents.**
- **The braking ability of your car is limited by the grip of the tyres. In this respect, your car is no different from a car without four-wheel drive. So do not be tempted to drive too fast on icy or slippery roads just because the car still has good acceleration in these conditions (accident risk).**
- **On wet roads bear in mind that the front wheels may start to "aquaplane" and lose contact with the road if the car is driven too fast. If this should happen, there will be no sudden increase in engine speed to warn the driver, as with a front-wheel drive car. So do not drive too fast in the wet: adjust your speed to suit the conditions (accident risk). ■**

## Power management

### This system helps to ensure reliable starting

*The power management controls the distribution of electrical energy and thus helps to ensure that there is always enough power available to start the engine.*

If a vehicle with a conventional electrical system is left parked for a long time, the battery will gradually lose its charge because certain electrical equipment (such as the immobiliser) continues to draw ►

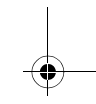
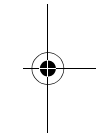
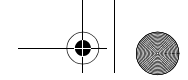
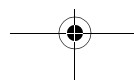
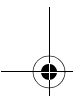
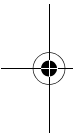

current even when the ignition is off. In some cases there may not be enough power available to start the engine.

Your vehicle is equipped with an intelligent power management system to control the distribution of electrical energy. This significantly improves reliability when starting the engine, and also prolongs the life of the battery.

The main functions incorporated in the power management system are **battery diagnosis**, **residual current management** and **dynamic power management**.

#### Battery diagnosis

The battery diagnosis function constantly registers the condition of the battery. Sensors detect the battery voltage, battery current and battery temperature. This enables the system to calculate the current power level and charge condition of the battery.

#### Residual current management

The residual current management reduces power consumption while the vehicle is parked. It controls the supply of power to the various electrical components while the ignition is switched off. The system takes the battery diagnosis data into consideration.

Depending on the power level of the battery, the individual electrical components are switched off one after the other to prevent the battery from losing too much charge and to ensure that the engine can be started reliably.

#### Dynamic power management

While the vehicle is moving, this function distributes the available power to the various electrical components and systems according to their requirements. The power management ensures that on-board systems do not consume more electrical power than the alternator can supply, and thus maintains the maximum possible battery power level.

#### Note

- The power management system is not able to overcome the given physical limits. Please remember that the power and life of the battery are limited.
- A warning message will appear ⇒ *page 228*, “Driver message in the instrument cluster display” if the battery power has dropped to a level where reliable starting is impaired. ■

#### Points to remember

##### *Starting ability has first priority.*

Short trips, city traffic and low temperatures all place a heavy load on the battery. In these conditions a large amount of power is consumed, but only a small amount is supplied. The situation is also critical if electrical equipment is in use when the engine is not running. In this case power is consumed when none is being generated.

In these situations you will be aware that the power management system is intervening to control the distribution of electrical power.

##### **When the vehicle is parked for long periods**

If you do not drive your vehicle for a period of several days or weeks, the power management will gradually shut off the on-board systems one by one, or reduce the amount of current they are using. This limits the amount of power consumed and helps to ensure reliable starting even after a long period.

Please note that certain convenience features, such as the Audi advanced key\*, the remote control key or the electrical seat adjustment may not be available when you unlock the vehicle. These functions will be restored when you switch on the ignition and start the engine. ►

### With the engine switched off

If you listen to the radio or use the other MMI functions when the engine is not running, this will discharge the battery.

The MMI display will show this warning message before the battery power drops to a level where the starting ability is impaired.

**Please start engine, otherwise system will switch off in 3 minutes.**

This message warns you that the system you are using will be switched off automatically after 3 minutes. You should therefore start the engine if you wish to continue using the system.

### When the engine is running

Although the alternator generates electrical power, the battery can still become discharged while the vehicle is being driven. This can occur when a lot of power is being consumed but only a small amount supplied, especially if the battery is not fully charged initially.

To restore the necessary energy balance, the system will then temporarily shut off the electrical components that are using a lot of power, or reduce the current they are consuming. Heating systems in particular use a large amount of electrical power. If you notice, for instance, that the seat heating\* or the rear window heater is not working, they may have been temporarily switched off or regulated to a lower heat output. These systems will be available again as soon as sufficient electrical power is available.

You may also notice that the engine runs at a slightly faster idling speed. This is quite normal, and no cause for concern. The increased idling speed allows the alternator to meet the greater power requirement and charge the battery at the same time. ■

### Driver message in the instrument cluster display

If battery power drops to a level at which you may encounter problems when starting the engine, the following message will appear in the instrument cluster display:

 **Low battery charge: Battery will be charged while driving**

This message reminds you that the starting reliability may be impaired. The message will disappear as soon as you set off and the battery is charged.

#### Message comes on and goes out again

If the message appears in the display after the ignition is switched on or while driving, and goes out again after a period of time, the battery has been charged up again sufficiently while the vehicle was being driven.

#### Message comes on and does not go out

If the message appears in the display after the ignition is switched on or while driving, and does not go out again, the battery is not being maintained at the proper power level. Starting reliability may be impaired. You should have the battery checked by a qualified workshop as soon as possible. ■

## Your vehicle and the environment

### Running in

A new vehicle should be run in over a distance of 1,500 km. For the first 1,000 km the engine speed should not exceed 2/3 of the maximum permissible engine speed – do not use full throttle and do not tow a trailer or caravan. From 1,000 to 1,500 km you can gradually increase the engine rpm and road speed.

During its first few hours of running, the internal friction in the engine is greater than later on when all the moving parts have bedded down.

How the vehicle is driven for the first 1,500 km also influences the engine quality. After the first 1,500 km you should continue driving at moderate engine speeds, in particular when the engine is cold. This helps to reduce wear and tear on the engine and increases the potential mileage which can be covered by the engine.

You should also avoid driving with the engine speed too *low*. Change down to a lower gear when the engine no longer runs “smoothly”. Excessively high engine speeds are prevented by an automatic rev limiter. ■

### Emission control systems

#### Catalytic converter

**Applies to vehicles with petrol engine:** The vehicle must only be used with unleaded petrol, otherwise the catalytic converter will be destroyed.

Never run the tank completely dry. The irregular fuel supply can cause misfiring, which would allow unburnt fuel to enter the exhaust system, which could cause overheating and damage the catalytic converter.

#### Diesel particulate filter

**Applies to vehicles with diesel engine:** The diesel particulate filter can filter out almost all soot particles contained in the exhaust gas. In normal driving conditions the filter is self-cleaning. Should the self-cleaning function of the filter not be able to operate, e.g. when the vehicle is continuously used only for short trips, the filter becomes obstructed with soot and the symbol  for the diesel particulate filter lights up ⇒ *page 38*.

#### WARNING

- **Because of the high temperatures which can occur in the emission control system (catalytic converter or diesel particulate filter), do not park the vehicle where the exhaust can come into contact with flammable materials under the car (e.g. on grass or at the forest edge). - Fire hazard!**
- **Do not apply any underseal agents in the area around the exhaust system - fire hazard! ■**

### How to improve economy and minimise pollution

Fuel economy, environmental impact and wear on the engine, brakes and tyres depend largely on the way you drive the vehicle. By adopting an economical driving style and anticipating the traffic situation ahead, you can reduce fuel consumption by 10-15%. The following section gives you some tips on lessening the impact on the environment and reducing your operating costs at the same time. ►

Controls

Safety

Driving tips

General maintenance

Self-help

Technical data

**Anticipate well in advance**

A car uses most fuel when accelerating. If you anticipate hazards and speed changes well in advance, you will need to brake less and thus accelerate less. Wherever possible, let the car slow down gradually **with a gear engaged**, for instance when you can see that the next traffic lights are red. This takes advantage of the engine braking effect, reducing wear on the brakes and tyres. Emissions and fuel consumption will drop to zero due to the overrun fuel cut-off.

**Change gear early to save fuel**

An effective way of saving fuel is to *change up quickly* through the gears. Running the engine at high rpm in the lower gears uses an unnecessary amount of fuel.

**Manual gearbox:** Shift up to second gear as soon as possible. If possible, we recommend shifting up to the next gear at approx. 2,000 rpm.

**Automatic gearbox:** Press the accelerator slowly and avoid using the "kick-down" feature.

**Avoid driving at high speed**

Avoid travelling at top speed. Fuel consumption, exhaust emissions and noise levels all increase very rapidly at higher speeds. Driving at moderate speeds will help to save fuel.

**Do not let the engine idle for longer than necessary**

It is worthwhile switching off the engine when waiting in a traffic jam, at level crossings or at traffic lights with a long red phase. The fuel saved after only 30 - 40 seconds is greater than the amount of fuel needed to restart the engine.

The engine takes a very long time to warm up when it is running at idling speed. Mechanical wear and pollutant emissions are also especially high during this initial warm-up phase. It is therefore best to drive off immediately after starting the engine. Avoid running the engine at high speed.

**Regular servicing**

Regular servicing can establish a basis for good fuel economy before you start driving. A well-serviced engine gives you the benefit of **improved fuel efficiency** as well as maximum reliability and an enhanced resale value. A badly tuned engine can consume up to ten percent more fuel than necessary.

**Avoid short trips**

The engine and emission control system need to reach their **proper working temperature** in order to minimise fuel consumption and emissions.

A cold engine uses disproportionately more fuel. The engine only reaches its working temperature after about *four* kilometres, when fuel consumption will return to a normal level. This is the reason why we recommend avoiding short trips wherever possible.

**Maintain the correct tyre pressures**

Always make sure the tyres are inflated to the correct pressures ⇒ *page 268* to save fuel. If the tyre pressures are just 0.5 bar too low, this can increase the fuel consumption by as much as 5 %. Due to the greater rolling resistance, under-inflation also increases **tyre wear** and impairs handling.

Do not use **winter tyres** all through the year; they will increase fuel consumption by up to 10 %.

**Avoid carrying unnecessary loads**

Every kilo of **extra weight** will increase the fuel consumption, so it is worth checking the luggage compartment occasionally to make sure that no unnecessary loads are being transported.

A **roof carrier** is often left in place for the sake of convenience, even when it is no longer needed. At a speed of 100-120 km/h your car will use about 12 % more fuel as a result of the extra wind resistance caused by the roof carrier - even when it is empty. ►





**Save electrical energy**

The engine drives the alternator to generate electricity. This means that fuel consumption rises when more power is required for electrical equipment. Switch off electrical equipment when it is not needed. Electrical equipment which uses a lot of electricity includes the blower (at a high setting), the rear window heating and the seat heating\*. ■

- Solvent-free adhesives
- No CFCs used in production
- Surplus materials used extensively for energy conversion and building materials
- Overall water consumption reduced
- Heat recovery systems
- Water-soluble paint ■

**Environmental compatibility**

Environmental protection is a top priority in the design, choice of materials and production of your new Audi.

**Design measures for economical recycling**

- Joints and connections designed for ease of dismantling
- Modular construction to facilitate dismantling
- Increased use of single-grade materials
- Plastic parts and elastomers are labelled in accordance with ISO 1043, ISO 11469 and ISO 1629

**Choice of materials**

- Nearly all materials used can be recycled
- Similar types of plastics grouped together for easy recycling
- Recycled materials used in manufacture
- Reduced vapour emissions from plastics
- CFC-free refrigerant in air conditioner

**Compliance with the laws prohibiting the use of:** Cadmium, asbestos, lead, mercury and chrome VI.

**Manufacturing methods**

- Using recycling material for manufacturing plastic parts
- Solvent-free cavity sealing
- Solvent-free wax for protecting the vehicles in transit

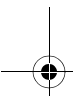
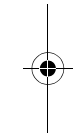
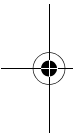

## Towing a trailer

### Driving the vehicle with a trailer or caravan

#### Technical requirements

*The towing bracket must comply with certain technical requirements.*

Your car is intended mainly for transporting passengers and luggage. However, if suitably equipped, it can also be used to tow a trailer or caravan.

If the car is supplied with a **factory-fitted** towing bracket it will already have the necessary technical modifications and meet the statutory requirements.

A 13-pin socket is provided to make the electrical connection between the car and the trailer. If the trailer has a **7-pin plug** you can use an adapter cable. This is available from Audi dealers.

#### WARNING

**If a towing bracket is retrofitted, the installation should be carried out by a qualified workshop.**

- **In particular in high outside temperatures it is not possible to drive up long steep gradients without a suitable cooling system. The engine would then overheat.**
- **Incorrect installation can result in a safety risk. ■**

#### Points to check before towing

##### Trailer weights

Never exceed the maximum permitted trailer weights ⇒ *page 323*.

If you do not load the trailer up to the maximum permitted trailer weight, you can then climb correspondingly steeper gradients.

The maximum trailer weights listed are only applicable for **altitudes** up to 1000 m above sea level. With increasing altitude the engine power and therefore the car's climbing ability are impaired because of the reduced air density, so the maximum trailer weight has to be reduced accordingly. The weight of the car and trailer must be reduced by 10% for every further 1000 m (or part thereof). This figure refers to the combined weight of the (loaded) vehicle and (loaded) trailer.

The figures for the **draw bar weight** that appear on the identification plate of the towing bracket are for certification purposes only. The correct figures for your specific vehicle, which may be *lower* than these figures for the towing bracket, are given in the registration documents. Also refer to ⇒ *page 323*.

##### Distributing the load

Distribute loads in the trailer so that heavy objects are as near to the axle as possible. Loads carried in the trailer must be secured to prevent them slipping.

Where possible, operate the trailer with the maximum permitted **draw bar weight** on the ball joint of the towing bracket, but do not exceed the specified limit.

##### Tyre pressure

Check the tyre pressures on your car and adjust for "full load" conditions (refer to the sticker listing the tyre pressures on the end face of the driver's door). It may also be necessary to adjust the tyre pressures on the trailer according to the recommendations of the trailer manufacturer.

##### Exterior mirrors

Check whether you can see enough of the road behind the trailer with the standard mirrors. If this is not the case you should have ►

additional mirrors fitted. Both exterior mirrors should be mounted on hinged extension brackets. Adjust the mirrors to give sufficient vision to the rear.

#### Headlights

Before starting a journey, check the headlight beam settings with the trailer hitched up. If necessary, alter the height of the headlight beams by means of the headlight range control ⇒ *page 60*.

#### Power supply

When you remove the ignition key the power supply to the trailer is interrupted.

#### Removable ball joint coupling

Vehicles with a factory-fitted towing bracket are equipped with a *removable* ball joint coupling. It is carried under the floor panel on the left-hand side of the luggage compartment and is secured by a strap.



#### Note

We recommend having the car serviced between the normal inspection intervals if it used frequently for towing a trailer. ■

Applies to vehicles: with towing bracket

### Trailer stabilisation system

*Trailer stabilisation helps to reduce the risk of the vehicle skidding when towing a trailer.*

The trailer stabilisation system is operational only when the ESP is switched on and there is no malfunction in the ESP ⇒ *page 17*.

#### When is the trailer stabilisation system activated?

Trailer stabilisation is active when the following requirements are met:

- The ESP must NOT be switched off ⇒ *page 222*,

- The trailer connector must be properly secured in the vehicle socket.
- Vehicle speed must be higher than approx. 60 km/h.

#### How trailer stabilisation works:

In many cases, the driver can stabilise a swaying trailer by manually braking the vehicle.

However, if the ESP detects that the trailer is swaying and this is affecting the towing vehicle, it will automatically brake the vehicle to stabilise the trailer by slowing it down. The warning lamp  will light up in the instrument cluster. If possible, do not turn the steering wheel at this stage.

In order to warn traffic behind you, the brake lights will come on during this automatic braking operation.

A trailer weighing less than 70% of the kerb weight of the towing vehicle may sway quite considerably without the trailer stabilisation system intervening. This can happen when the swaying movements of the light-weight trailer are not or hardly passed on to the towing vehicle and are therefore not detected by the ESP.

If the system for activating the trailer brake lights is defective, this will be indicated in the instrument cluster display ⇒ *page 37*, "Bulb monitor ".

#### Requirements for correct functioning of the trailer stabilisation system

If these conditions are not met in full, the trailer stabilisation system will only intervene to a limited extent or not at all ⇒ .

- The electrical connection between the towing vehicle and the trailer must be functioning correctly, without any defects.
- The load on the trailer must be properly secured.
- The tyre pressures on both the vehicle and the trailer must be adapted to the load that is being carried.
- Where possible, operate the trailer with the maximum permitted draw bar weight. ▶

- The trailer overrun brake must be set correctly. This is important to ensure that the trailer can be braked correctly, to avoid the vehicle and trailer “jack-knifing” and to prevent excess braking of the trailer.
- At low outside temperatures, both the towing vehicle **and** the trailer should be fitted with winter tyres.

 **WARNING**

**It is essential that you adjust your speed to suit the weather, road and traffic conditions. Do not let the trailer stabilisation system tempt you into taking any risks when driving – this can cause accidents.**

- **The ESP and trailer stabilisation system cannot defy the laws of physics. This should be kept in mind, particularly on slippery and wet roads and when towing a trailer with a light load.**
- **The trailer stabilisation system is functional, regardless of whether the trailer has a mechanical overrun brake or not.**
- **The trailer stabilisation system is not always able to detect swaying of trailers with a light load and will therefore not intervene.**
- **A trailer can still “jack-knife” on slippery roads with little grip, even if the towing vehicle is equipped with the trailer stabilisation system.**
- **Trailers with a high centre of gravity may even tip over before they start to sway sideways.**
- **If you are not towing a trailer, but the trailer socket is being used (e.g. for an illuminated bicycle rack), the trailer stabilisation system may be activated in extreme driving conditions.**
- **Please note the additional information and warnings**  
⇒ **page 234.** ■

## Notes on towing

*Driving with a trailer always requires extra care.*

### Weight distribution

Try to avoid towing a loaded trailer with an unladen vehicle. If this cannot be avoided, drive extra slowly to allow for the unbalanced weight distribution.

### Speed

The stability of the car and trailer is reduced with increasing speed. For this reason it is advisable not to drive at the maximum permissible top speed in unfavourable road, weather or wind conditions. This applies especially on a downhill gradient.

You should always reduce speed immediately if the trailer shows the slightest sign of **swaying**. Never try to stop the swaying by accelerating further.

Always brake in good time. If the trailer has an **overrun brake**, apply the brakes *gently at first* and then firmly. This will prevent the jerking that can be caused by the trailer wheels locking. Change down in good time before going down a steep hill so that you can use the engine braking effect to slow down the vehicle.

**Swaying and pitching** can be reduced by stabiliser aids. We recommend having stabiliser aids installed when towing trailers with a high trailer weight. They can be purchased and installed at an Audi dealer.

### Overheating

When climbing long hills in hot weather with the engine running fast in low gear, you should keep an eye on the coolant temperature gauge ⇒ *page 11*. Reduce speed immediately if the needle moves to the top end of the scale. If the temperature warning lamp  in the instrument cluster should start flashing, stop the car and let the engine cool down by running it *at idling speed* for a few minutes. ■

Applies to vehicles: with towing bracket

### Accessories

*Before mounting equipment and accessories (e.g. bicycle rack) please observe the following notes.*

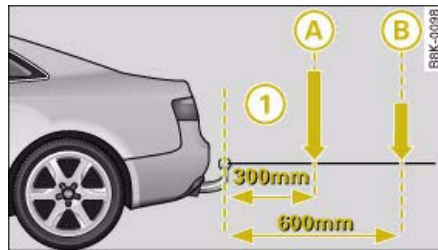

Fig. 234 Load distribution of equipment and accessories

The equipment/accessories mounted must not protrude more than 700 mm from the ball joint ①.

The total weight (mounted equipment plus the load) must not exceed 75 kg.

The maximum load depends on where the centre of gravity lies.

The maximum weight decreases as the distance between the centre of gravity and the ball joint ① increases.

The following limits apply:

If the distance is 300 mm, the total weight (incl. the equipment mounted) ② must not exceed 75 kg.

If the distance is 600 mm, the total weight (incl. the equipment mounted) ③ must not exceed 35 kg.

Only bicycle racks for a **maximum of three** bicycles may be used.

#### Equipment mounted on the towing bracket

We recommend that you only mount equipment (e.g. bicycle rack) which has been approved by Audi on the ball joint. If you wish to attach other equipment please make sure that it has been approved

by the manufacturer for use on the ball joint. If you mount unsuitable equipment, this can cause damage to the towing bracket. In an extreme case, damage to the towing bracket could cause it to break ⇒ ⚠.

### ⚠ WARNING

- If you wish to mount equipment which has not been approved by Audi please ensure that it is suitable for use on Audi vehicles.
- Use of unsuitable equipment can result in severe damage to the towing bracket. The towing bracket could then break while pulling a trailer and cause an accident.
- Never use tools of any kind when fitting and removing the ball joint. This could damage the mechanism which locks the ball joint in place and impair its safety (accident risk). ■

## Removable towing bracket

Applies to vehicles: with removable towing bracket

### Introduction

*Special care is required when fitting and removing the towing bracket.*

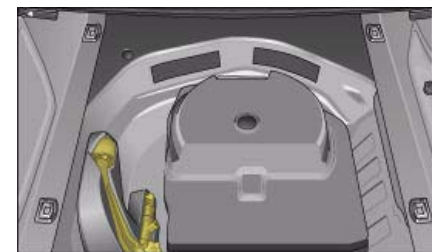

Fig. 235 Luggage compartment with towing bracket

Controls

Safety

Driving tips

General maintenance

Self-help

Technical data

The removable ball joint attachment for the towing bracket is carried under the floor panel on the left-hand side of the luggage compartment and is secured by a strap.

The ball joint can be fitted and removed by hand.

**WARNING**

- Never use tools of any kind when fitting and removing the ball joint. This could damage the mechanism which locks the ball joint in place and impair its safety (accident risk).
- Secure the ball joint again with the strap when you have finished using it.

**Note**

- Do not attempt to modify or repair the ball joint or other towing bracket components.
- Should you have any difficulties when using the towing bracket, or suspect that it is not fitted properly, contact a qualified workshop.
- Before setting off, always check that the ball joint is secured properly ⇒ *page 238*.
- Never disengage the ball joint with the caravan / trailer still hitched or with a bicycle rack or similar accessory still attached.
- It is advisable to remove the ball joint when you are not towing a trailer. Fold the socket back to its original position so that the mounting fixture is properly closed.
- The ball joint must be removed if you intend to clean the car with a steam cleaning attachment. Make sure that the mounting fixture is properly closed.
- For installation and removal of the ball joint we recommend that the gloves provided be used. ■

Applies to vehicles: with removable towing bracket

**Fitting the ball joint (step 1)**

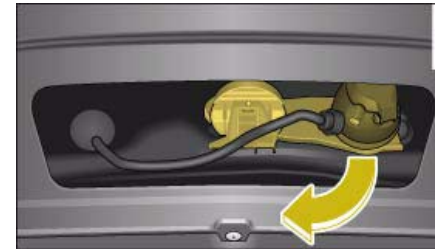

Fig. 236 Area below rear bumper: Folding down the socket



Fig. 237 Socket (folded down)

- Fold the socket unit all the way out in the direction of the arrow ⇒ fig. 236.
- The cover piece is held automatically in the open position.
- Check that the mounting for the towing bracket, which will now have become visible -arrow- ⇒ fig. 237, is free of dirt, and clean if necessary ⇒ ⚠.

- Also check the shaft section of the ball joint and its associated mechanical parts to make sure they are clean and undamaged.

Continued ⇒ page 237, "Fitting the ball joint (step 2)".

**! WARNING**

**It is important to keep the mounting fixture clean. Otherwise the ball joint may fail to engage securely (accident risk). ■**

Applies to vehicles: with removable towing bracket

**Fitting the ball joint (step 2)**

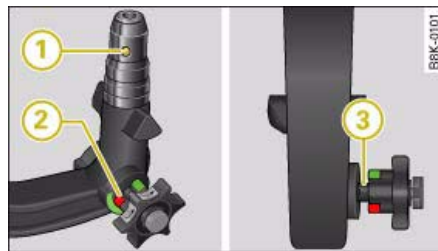

Fig. 238 Removable towing bracket: Ball joint

**The spring mechanism inside the ball joint must be in the "ready" position.**

- Check that the red marking (2) ⇒ fig. 238 on the knob is inside the green zone on the ball joint.
- Check that the locking ball (1) is inside the hole in the shaft section of the ball joint.
- Check that the knob protrudes visibly from the ball joint, so that there is a clear gap (3) between the knob and the ball joint.

The ball joint can only be installed if the internal spring mechanism is in the **ready** position.

Continued ⇒ page 237, "Fitting the ball joint (step 3)". ■

Applies to vehicles: with removable towing bracket

**Fitting the ball joint (step 3)**

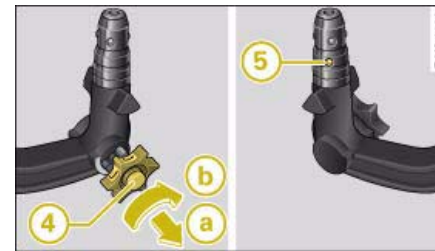

Fig. 239 Removable towing bracket: Setting the spring mechanism to the "ready" position

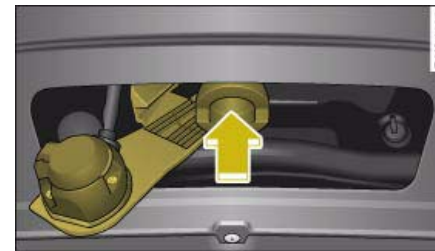

Fig. 240 Removable towing bracket: Inserting the ball joint

**Setting the spring mechanism to the "ready" position (if required)**

- Insert the key (4) ⇒ fig. 239 for locking the ball joint into the lock on the knob and turn it clockwise. ▶

- Pull out the knob in direction (a), hold and turn in direction (b) until the locking ball (5) engages ⇒ ⚠.

### Inserting the ball joint

- With the spring mechanism in the "ready" position, insert the ball joint into the mounting fixture and push it upwards ⇒ page 237, fig. 240 in the direction indicated (arrow) ⇒ ⚠. The spring mechanism should then engage automatically with an audible click.
- Lock the ball joint by turning the key anti-clockwise.
- Take out the key and press the cover cap provided onto the lock.

Continued ⇒ page 238, "Fitting the ball joint (step 4)".

### ⚠ WARNING

- If it is not possible to set the spring mechanism to the "ready" position as described above, do not use the ball joint. Please take your vehicle to a qualified workshop.
- To avoid injury, keep your hands away from the knob and the cover piece when inserting the ball joint into the mounting fixture.

### i Note

Make sure that the knob can turn freely when the ball joint is inserted. ■

Applies to vehicles: with removable towing bracket

### Fitting the ball joint (step 4)

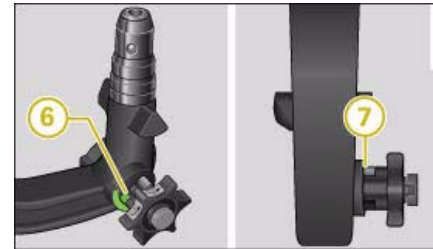

Fig. 241 Removable towing bracket: Safety check

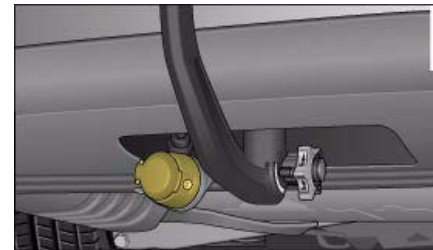

Fig. 242 Area below rear bumper: Electrical socket for trailer

### Safety check

- Check that the green marking (6) ⇒ fig. 241 on the knob is inside the green zone on the ball joint.
- Check that the knob is directly against the ball joint, so that there is no gap (7) between the knob and the ball joint.
- Check that the ball joint is locked and the key is removed (so that the knob cannot be pulled out). ▶



- Check that the ball joint fits tightly in the mounting fixture (try moving it about to check).

#### Electrical socket for trailer

- The cable of the towing bracket can be connected to the socket ⇒ *page 238*, fig. 242.

If the safety check is not satisfactory, the ball joint must be fitted again properly.

#### WARNING

To avoid accidents, the ball joint must meet all the safety requirements listed in the safety check. The towing bracket must not be used if any one of these requirements is not met. If this is the case, you should contact a qualified workshop. ■

Applies to vehicles: with removable towing bracket

#### Removing the ball joint

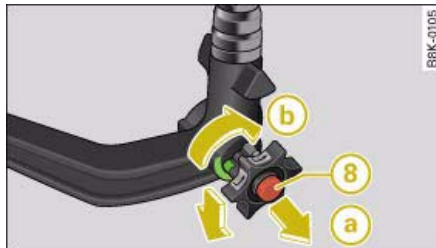

Fig. 243 Removable towing bracket: Removing the ball joint

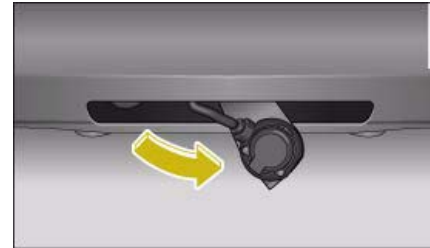



Fig. 244 Area below rear bumper: Folding up the socket

- Take off the cover cap and insert the key (8) ⇒ fig. 243 in the lock on the knob.
- Unlock the ball joint by turning the key clockwise.
- Take hold of the ball joint and pull out the knob in direction (a).
- Keep hold of the knob and turn it as far as it will go in direction (b).
- Release the knob. The spring mechanism will remain in the "ready" position ⇒ .
- Pull the ball joint down out of the mounting fixture.
- Then swivel the socket up ⇒ fig. 244 as far as it will go. The mounting fixture will be closed automatically.
- Put away the ball joint attachment under the floor panel in the luggage compartment.

#### WARNING

Make sure that the socket unit has closed off the mounting fixture of the towing bracket properly. Otherwise the ball joint may fail to engage securely if dirt accumulates in the mounting fixture. ■

Applies to vehicles: with towing bracket

### Towing bracket (retrofitting)

If required, the vehicle can be retrofitted with a towing bracket.

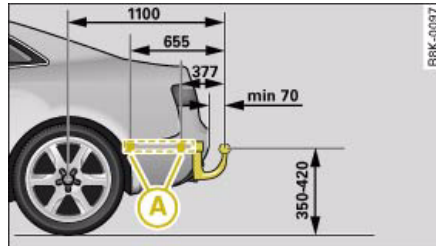

Fig. 245 Positions of securing points (side view)

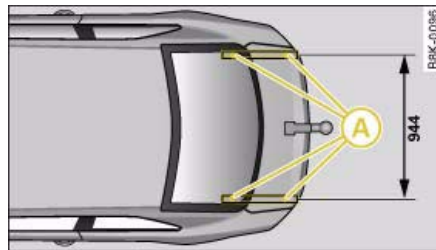

Fig. 246 Positions of securing points (from above)

If a towing bracket is to be fitted after the car is purchased, this must be done according to the instructions of the towing bracket manufacturer.

The securing points, which are marked by an **A** in the illustrations ⇒ fig. 245 and ⇒ fig. 246, are located under the vehicle.

Audi dealers are familiar with the method of installation and any modifications which may be required for the cooling system.

### ! WARNING

- If a towing bracket is retrofitted, the installation should be carried out by a qualified workshop.
- If the towing bracket is incorrectly fitted, this could cause a safety risk.
- For your own safety, please observe the instructions provided by the manufacturer of the towing bracket.

### ! Caution

If the connector socket is not fitted correctly, this could cause damage to the vehicle's electrical system. ■

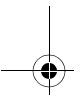
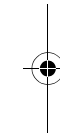
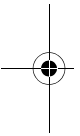

Controls

Safety

Driving tips

General maintenance

Self-help

Technical data

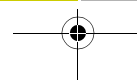

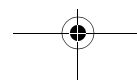
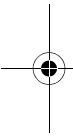

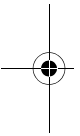

## Care of vehicle and cleaning

### General notes

*Regular care helps to maintain the value of the vehicle.*

Regular and careful care helps to **maintain the value** of the vehicle. This may also be one of the requirements for upholding any warranty claims in the event of corrosion or paint defects.

Audi dealers and specialist retailers carry stocks of suitable **car care products**. Please follow the instructions for use on the packaging.

#### **WARNING**

- **Cleaning products and other materials used for car care can damage health if misused.**
- **Car care products can contain toxic substances and must always be kept in a safe place out of reach of children.**

#### **For the sake of the environment**

- When purchasing car care products, try to select ones which are not harmful to the environment.
- Surplus cleaning materials should not be disposed of together with ordinary household waste. ■

### Care of exterior

#### Washing the vehicle

The longer substances like insects, bird droppings, resinous tree sap, road dirt, industrial deposits, tar, soot or road salt and other aggressive materials remain on the vehicle, the more damage they

do to the paintwork. High temperatures (for instance in strong sunlight) further intensify the corrosive effect.

After the period when salt is put on the roads it is important to have the **underside** of the vehicle washed thoroughly.

#### Automatic car washes

Before going through a car wash, be sure to take the usual precautions such as closing the windows and sunroof. If the vehicle has special accessories such as spoilers or a roof carrier or two-way radio aerial, etc., it is advisable to consult the car wash operator.

It is best to use a car wash without revolving bristles if possible.

#### Washing your car with a high-pressure cleaner

When cleaning the vehicle with a high-pressure cleaner, always follow the operating instructions for the equipment. This applies particularly to the **operating pressure** and the **spraying distance**. Do not hold the spray nozzle too close to soft materials, such as rubber hoses or seals.

Do not use a nozzle that sprays the water out in a **direct stream** or one that has a **rotating jet** for forcing off dirt.

#### Washing the car by hand

When washing the car by hand, use plenty of water to soften the dirt first, and rinse off as well as possible.

Then clean the vehicle with a soft **sponge, glove or brush**, using only slight pressure. You should start on the roof and work down. Special **car shampoo** should only be used for very persistent dirt.

Rinse the sponge or glove thoroughly and often.

Wheels, sills and similar should be cleaned last. Use a second sponge for this. ▶

 **WARNING**

- Do not wash the vehicle with the ignition switched on – risk of accident.
- Do not clean the underside of the car or inside the wheel arches without protecting your hands and arms. You may cut yourself on sharp metal parts.
- Take care when washing the car during the winter: moisture and ice on the brakes may affect braking efficiency – this could cause an accident.

 **Caution**

- Do not wash the vehicle in direct sunlight – otherwise the paint can be damaged.
- Do not use insect sponges or abrasive household sponges, etc. – they can damage the surfaces.
- The headlights should only be washed with water – do not wipe them with a dry cloth or sponge. It is best to use soapy water.
- Never wash tyres with a jet that sprays the water out in a direct stream. This could damage the tyres – even if the spray is kept at a distance and only used for a very short time.

 **For the sake of the environment**

The car should only be washed in special wash bays. This prevents oily water from getting into the public drains. In some districts, washing vehicles anywhere else may be prohibited. ■

## Waxing and polishing

### Waxing

Waxing protects the paintwork. It is time to apply a good coat of **wax** when water no longer **forms droplets** and rolls off the clean paintwork.

Even if a **wax solution** is used regularly in the car wash, it is advisable to protect the paint with a coat of wax at least twice a year.

In the summer, you will find it is much easier to remove dead insects (which accumulate on the bumper and the front of the bonnet) if the car has been waxed *recently*.

### Polishing

Polishing is only necessary if the paint has lost its shine, and the gloss cannot be brought back by putting on wax.

The car must be waxed after polishing if the polish used does not contain wax compounds to seal the paint.

 **Caution**

Matt painted and plastic parts must not be treated with wax or polish. ■

## Ornamental trim and mouldings

The metal brightwork on the body is made of aluminium rather than chrome (for environmental reasons).

Dirt or marks on the trim mouldings should be removed with an **acid-free cleaning agent** (do not use a chrome cleaner). Body polish is also unsuitable for use on trim mouldings. The intensive cleaning fluids often used before the car goes into a car wash may contain alkaline substances, which can cause dull or milky patches when they dry out.

Audi dealers carry stocks of cleaning products which have been tested for use on your vehicle and are not harmful to the environment. ■

### Plastic parts

Plastic parts will come clean with regular washing. If this is not sufficient, plastic parts should only be treated with a special solvent-free **plastic cleaning agent**. Do not use paint cleaners, polishes or wax on plastic parts. ■

### Paint damage

Minor damage to the paint, such as scratches or stone chips, should be touched up *without delay* before the metal starts to corrode. Suitable **touch-up brushes** or **sprays** for your car can be obtained from an Audi dealer.

The number of the original paint finish on the vehicle is given on the data sticker ⇒ *page 321*.

If corrosion is already visible it must be thoroughly removed by a qualified workshop. ■

### Windows

*Clear vision is an essential safety factor.*

The windscreen must not be cleaned with insect remover or wax, otherwise the windscreen wipers will not function properly (juddering).

Traces of rubber, oil, grease or silicone can be removed with a **window cleaning solution** or a **silicone remover**. Wax residue can only be removed with a special cleaner. Your Audi dealer will be able to provide you with more detailed information.

The windows should also be cleaned on the inside at regular intervals.

Use a separate cloth or chamois to dry the windows. Cloths used for waxing and polishing contain residues that will cause smears on the glass.

### WARNING

**Do not use water-repellent coatings on the windscreen. In bad visibility conditions such as light rain, low sun or when driving at night these coatings can cause increased dazzle, which is a serious safety hazard. Such coatings can also cause the wiper blades to judder.**

### Caution

- Remove snow and ice from windows and mirrors with a **plastic scraper** only. To avoid scratches caused by dirt on the glass, the scraper should only be pushed in one direction and not moved to and fro.
- The heating element for the rear window is located on the inner side of the window. To avoid damaging the heating element, do not put stickers on the inner side of the window.
- Never use warm or hot water to remove snow and ice from windows and mirrors. This could cause the glass to crack! ■

### Rubber seals (weatherstrips)

The weatherstrips will remain pliable and last longer if they are occasionally treated with a suitable care product (for example silicone spray). This will also prevent premature ageing and leaks. The doors will be easier to open as well. If they are kept pliable, the door seals will be less likely to freeze up in the winter. ■

### Wheels

The wheels require regular attention to preserve their appearance. It is important to remove road salt and brake dust by washing the wheels at regular intervals, otherwise the finish will be impaired. ►



After washing, the wheels should only be cleaned with an "acid-free" cleaning agent for alloy wheels. This is available from Audi dealers and specialist retailers. Never leave the cleaning agent on the rims for any longer than specified in the instructions before rinsing it off. If the wheel cleaner fluid contains acid it can attack the surfaces of the wheel bolts.

Car polish or other abrasive agents should not be used. If the protective paint coating is damaged by stone chips etc., the damaged area should be touched up immediately.

#### WARNING

Please note when cleaning the wheels that water, ice and road salt can impair the effectiveness of the brakes – this can cause an accident. ■

## Care of interior

### Sound system / MMI\* display screen and MMI control console\*

The display screen can be cleaned with a soft cloth and a special "LCD cleaner" (available from retailers of electrical goods). Moisten the cloth with a small amount of the cleaning fluid.

Clean the MMI control console with a fine brush first to prevent any dirt from getting in between the control buttons and the housing. We then recommend wiping the MMI control console using a cloth moistened with washing-up liquid and water.

#### Caution

To avoid scratching the screen, do not wipe the display with a dry cloth.

- To avoid any possibility of damage, do not let any liquid get inside the control console. ■

### Plastic parts and leatherette

Plastic parts and leatherette can be cleaned with a damp cloth. If this is not sufficient, plastic parts and leatherette should only be treated with a **special solvent-free plastic cleaner**. ■

### Textile covers and trim parts

Textile covers and trim parts (e.g. seats, door trim) should be cleaned regularly with a vacuum cleaner. This will remove surface dirt which could otherwise be rubbed into the textile material during use. Do not use steam cleaners, as the steam could carry the dirt deeper into the textile material.

#### Normal cleaning

We recommend that you use a soft sponge or lint-free, micro-fibre cloth for normal cleaning. Only use brushes on floor coverings and mats, as other textile surfaces could become damaged.

In the case of normal surface dirt you can use a foam cleaner. Use a sponge to spread the foam on the textile surface and to work it into the material lightly. However, make sure that the textile material does not become soaking wet. Then dab off the foam with a dry and absorbent cloth (e.g. a micro-fibre cloth) and vacuum off any residue once the surface is completely dry.

#### Removal of stains

To treat stains caused by spilled drinks (coffee, fruit juice or similar) make up a solution with a mild detergent for sensitive fabrics and apply it with a sponge. If the stains are difficult to remove, a washing paste can be applied directly onto the stain and worked into the fabric. The surface will then have to be wiped with clear ►

Controls

Safety

Driving tips

General maintenance

Self-help

Technical data

water to remove any residue left by the paste. To do so, use a damp cloth or sponge and then dab the stain with an absorbent cloth.

Treat chocolate or make-up stains with a washing paste and then rinse off with water (using a damp sponge).

A spirit-based cleaner can be used to remove grease, oil, lipstick or ball point pen. Then dab the dissolved grease or colour particles off with an absorbent cloth or similar. You may also have to treat the stain once more using washing paste and water.

If the covers or textile trim panels are badly soiled we recommend that you have them cleaned by a professional cleaning company.

#### Note

Please make sure you close any velcro fasteners on your clothing, as these could otherwise damage the upholstery. ■

Applies to vehicles: with leather upholstery

### Natural leather

*Audi does everything possible to preserve the special qualities of leather as a natural product.*

#### General notes

We have a wide selection of leathers. The main type used is nappa in various forms, that is leather with a smooth surface in a selection of colours.

The amount of dye used determines the appearance and properties of leather. If the leather is left in a more natural state, it retains its typical natural appearance and is pleasant and comfortable for the seat occupants. Fine veins, healed scars, insect bites, wrinkles and a subtle variation in shading remain visible; these are the characteristic features of genuine natural leather.

Natural napped leather does not have a protective surface coating of dye. It is therefore somewhat more prone to damage. You should

bear this in mind if children or pets often travel in the car, or if there are other factors that could lead to damage.

Types of leather with a coloured surface coating are likely to be more resistant to damage. This has a great advantage for day-to-day use. However, this means that the typical natural characteristics of the surface are less apparent, though this does not affect quality.

#### Cleaning and care

Because of the natural properties of the specially selected hides employed, the finished leather has a certain sensitivity to grease and dirt, etc. so a degree of care is required in everyday use and when looking after the leather. Dark clothing (especially if damp or incorrectly dyed) may stain leather upholstery. Dust and grit in the pores and seams can have an abrasive effect and damage the surface of the leather. Therefore leather should be cleaned at regular intervals, depending on the actual amount of use. When they have been in use for a certain time, your car seats will acquire a typical and distinctive patina. This is characteristic for real leather upholstery, and is a sign of genuine quality.

To maintain the value of natural leather you should note the following points:

#### Caution

- Avoid exposing leather to direct sunlight for long periods, otherwise it may tend to lose some of its colour. If the car is left for a prolonged period in the bright sun, it is best to cover the leather.
- Sharp-edged objects on clothing, such as belts, zip fasteners, rivets or similar, can also leave permanent scratches and rough marks on the surface of the leather.

#### Note

- Use a suitable impregnating cream with ultra-violet protection at regular intervals and after cleaning. This cream will nourish and moisturise the leather, keep it supple and able to breathe. In addition, it will also help to protect the surface of the leather. ►

- Clean the leather every 2 to 3 months and remove fresh dirt as necessary.
- Remove stains from fresh ball-pen and other inks, lipstick, shoe cream and similar stains as soon as possible.
- Preserve the colour of the leather. A special coloured cream will renew the colour of the leather when required and will eliminate differences in colour. ■

Applies to vehicles: with leather upholstery

### Cleaning and care of leather upholstery

*Natural leather requires an extra degree of attention and care.*

#### Normal cleaning

- Moisten a cotton or woollen cloth with water and wipe over the leather surfaces.

#### More stubborn dirt

- More stubborn dirt can be removed using a mild soap solution (pure liquid soap: two tablespoons dissolved in one litre of water).
- It is very important not to let the water soak through the leather or penetrate into the seams.
- Then wipe off with a soft, dry cloth.

#### Removal of stains

- Remove fresh **water-based** stains such as coffee, tea, juices, blood etc. with an absorbent cloth or kitchen roll, dried-on stains with the cleaning agent from the care set.

- Remove fresh **fat-based** stains on the surface such as butter, mayonnaise, chocolate, etc. with an absorbent cloth or kitchen roll or with the cleaning agent from the care set.
- Treat **fat-based, dried-in** stains with grease-dissolving spray.
- Treat **less common stains** such as ball-pen and other inks, felt-tip pens, nail polish, dispersion paint, shoe cream etc. with a special leather stain remover.

#### Leather care products

- The leather should be treated regularly (about twice a year) with a special leather-care product.
- Apply the cream very sparingly.
- Then wipe off with a soft, dry cloth.

Should you have any questions regarding the care and cleaning of the leather upholstery in your vehicle, we recommend that you contact your Audi dealer. The staff there will gladly provide you with further information on cleaning and care of your upholstery and on our complete range of leather care products:

- Cleaning and care set
- Coloured leather-care cream
- Stain remover for ball-pen inks, shoe cream etc.
- Grease dissolving spray
- New products and further developments

#### Caution

On no account use solvents (such as petrol, turpentine), wax polish, shoe cream or similar materials. ■



Applies to vehicles: with Alcantara seat covers

### Cleaning Alcantara

#### Removing dust and dirt

- Moisten a cloth *just a little* and wipe down the seat covers.

#### Removing stains

- Moisten a cloth with lukewarm water or diluted **methylated spirits**.
- Dab at the stain. Start at the outside and work inwards.
- Dry the area you have cleaned with a soft cloth.

Do not use leather cleaning products on Alcantara seat covers.

You may use a suitable shampoo on dust and dirt.

Dust and grit in the pores and seams can have an abrasive effect and damage the surface of the leather. If the car is left standing in the sun for long periods, the leather should be protected against direct sunlight to prevent it from fading. However, slight colour variations will arise in normal use.

#### Caution

- Do not use solvents, wax polish, shoe cream, stain removers, leather cleaning products or any similar products on Alcantara.
- To avoid damage, stubborn stains should be removed by a qualified workshop.
- On no account use brushes, hard sponges or similar utensils. ■

### Seat belts

*Seat belts should be looked after properly to ensure that they give the full protection.*

- Keep the seat belts clean.
- For cleaning, use a mild soap solution.
- Check the condition of the seat belts at regular intervals.

Very dirty belts may not retract properly.

Make sure that the inertia reel seat belts are completely dry before allowing them to retract.

#### Caution

- Do not remove the seat belts from the vehicle to clean them.
- Do not use chemical cleaning agents on the seat belts, as this can damage the webbing. Ensure that the belts do not come into contact with corrosive fluids.
- If you find any damage to the belt webbing, belt fittings, the belt retractor or the buckle, the belt in question must be replaced by a qualified workshop. ■

## Fuel and filling the tank

### Petrol

Applies to vehicles: with petrol engine

#### Petrol grade

*The correct grade of petrol is listed inside the fuel tank flap.*

The vehicle is equipped with a catalytic converter and must only be run on **unleaded petrol**. Unleaded petrol must comply with the European EN 228 standard. The petrol grades have different **octane ratings** (RON). If, in exceptional circumstances, the correct octane rating is not available, please note the following:

- For engines which require **Premium unleaded petrol (95 RON)** according to ⇒ *page 323, "Performance, weights and dimensions"*: Regular unleaded fuel with 91 RON can also be used. This will, however, result in a slight loss of power.
- For engines which require **Super Plus unleaded petrol (98 RON)** according to ⇒ *page 323, "Performance, weights and dimensions"*: Premium unleaded fuel with 95 RON can also be used. This can, however, result in a slight loss of power under certain driving conditions. – If premium unleaded petrol is not available, the engine can be run on regular unleaded petrol with 91 RON as an *emergency measure*. In this case only use moderate engine speeds and a light throttle. Fill up with premium or Super Plus petrol as soon as possible.

#### ⚠ Caution

- Petrol complying with the EN 228 standard can contain small quantities of ethanol. However, "bioethanol fuels", which are retailed under various different names such as E50 and E85, and which contain a large proportion of ethanol, must **not** be put into the vehicle, as this would damage the fuel system.

- Even one tankful of leaded fuel would permanently impair the efficiency of the catalytic converter.
- High engine speed and full throttle can damage the engine when using petrol with an octane rating lower than the correct grade for the engine. ■

### Diesel

Applies to vehicles: with diesel engine

#### Diesel fuel

*Please note the information on the inside of the fuel tank flap.*

Diesel fuel must comply with the European EN 590 standard. It must have a cetane number (CN) of at least 51. The cetane number indicates the ignition quality of the diesel fuel.

#### Winter-grade diesel

Diesel fuel can thicken in winter. For this reason petrol stations in some countries also offer winter diesel.

#### ⚠ Caution

- The vehicle is **not** designed for the use of biodiesel (FAME fuel). The fuel system would be damaged if you used biodiesel.
- Do not mix fuel additives ("thinners", petrol or similar additives) with the diesel fuel.
- If poor-quality diesel fuel is used, it may be necessary to drain the water separator on the **fuel filter** more frequently than is specified in the Service Schedule. We recommend having this done by a specialist workshop. If water is allowed to collect in the filter, this can cause engine performance problems. ■

Controls

Safety

Driving tips

General maintenance

Self-help

Technical data

## Filling the tank

### Filling the tank

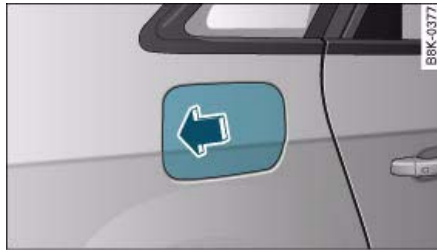

Fig. 247 Vehicle as seen from the rear right: Opening fuel tank flap

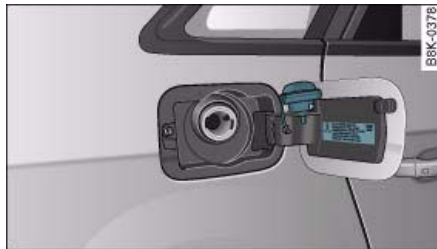

Fig. 248 Fuel tank flap with tank cap attached

The flap that covers the tank cap is unlocked and locked automatically by the central locking.

#### Unscrewing the tank cap

- Press the left side of the flap to open it ⇒ fig. 247 -arrow-.
- Unscrew the tank cap anti-clockwise.
- Hook the cap onto the open flap ⇒ fig. 248.

#### Closing the tank cap

- Screw on the tank cap clockwise until it cannot be turned further.
- Press the left side of the flap to close it (you should hear it click into place).

When the automatic filler nozzle is operated correctly it will switch itself off as soon as the tank is “full”. Do not try to put in more fuel after the nozzle cuts out, as this will fill the expansion chamber in the fuel tank.

The correct fuel grade for your vehicle is given on a sticker on the inside of the tank flap. Further notes on fuel ⇒ *page 251*.

The tank capacity of your vehicle is given in the **Technical data** section ⇒ *page 321*.

#### **⚠ WARNING**

**Fuel is highly flammable and can cause serious burns and other injuries.**

- For safety reasons always switch off the auxiliary heating\* before refuelling the vehicle.
- For safety reasons we do not recommend carrying a spare fuel canister in the vehicle. The canister could become damaged in an accident and leak.
- Observe all relevant statutory regulations on using, storing and transporting spare fuel canisters.
- When filling your tank or a spare fuel canister with fuel, do not smoke and keep away from naked flames. Risk of explosion!
- If, in exceptional circumstances, you have to carry a spare fuel canister, please observe the following warnings:
  - Never fill fuel into the spare fuel canister with the canister placed in or on top of the vehicle. An electrostatic charge could build up during filling, causing the fuel vapour to ignite. Danger of explosion. Always place the canister on the ground to fill it. ▶

**⚠ WARNING (continued)**

- Insert the filler nozzle as far as possible into the spare fuel canister.
- If the spare fuel canister is made of metal, the filler nozzle must be in contact with the canister during filling. This helps prevent an electrostatic charge building up.
- Make sure you never spill fuel in the vehicle or in the luggage compartment. Fuel vapour is explosive. Risk of fatal accident!

**⚠ Caution**

- If any fuel is spilt onto the vehicle, it should be removed immediately, as it could otherwise damage the paintwork.
- Never run the tank completely dry. If there is an irregular fuel supply, misfiring can occur. As a result unburnt fuel can enter the exhaust system and cause damage to the catalytic converter(s).
- When filling the fuel tank after having run it completely dry on a vehicle with a **diesel engine** the ignition must be switched on for at least 30 seconds without starting the engine. When you then start the engine it may take longer than normal (up to one minute) for the engine to start firing. This is because air needs to be bled from the fuel system while starting.

**🌸 For the sake of the environment**

Do not try to put in more fuel after the automatic filler nozzle has switched off; this may cause the fuel to overflow if it becomes warm.

**ℹ Note**

The tank flap is not locked when you lock the vehicle from the inside. ■

**Releasing the tank flap manually**

*The tank flap can be released manually if the central locking system should fail to operate.*

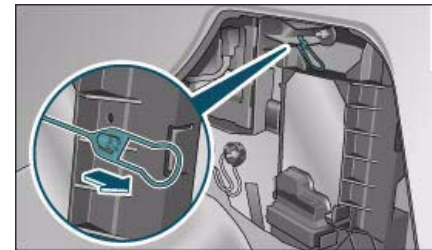

**Fig. 249 Luggage compartment: Releasing the fuel tank flap manually**

The manual release mechanism is located behind the side trim on the right of the luggage compartment.

- Open the right-hand side trim.
- Release the ring from its holder and pull the ring ⇒ fig. 249. You should now be able to open the tank flap in the usual way ⇒ *page 252*. ■

## Checking and topping up fluids

### Bonnet

#### Releasing the bonnet

*The bonnet is released from inside the vehicle.*

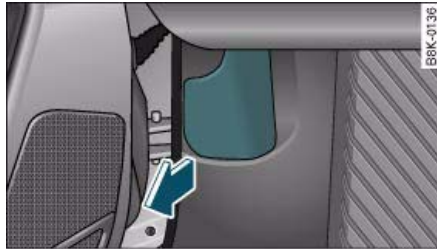

Fig. 250 Detail of footwell on driver's side: Release lever

- Open the driver's door.
- Pull the lever under the dashboard in the direction indicated (arrow) ⇒ fig. 250.

The bonnet springs out of its lock. ■

#### Opening the bonnet

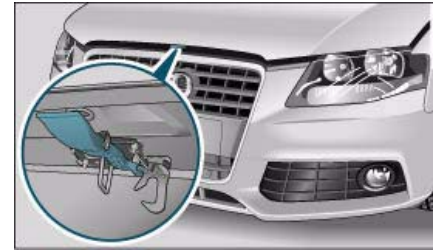

Fig. 251 Release catch under the bonnet

*Before opening the bonnet make sure that the windscreen wiper arms are not lifted away from the glass. Otherwise the paint may get damaged.*

- Lift the bonnet slightly ⇒ ⚠.
- Press the release catch under the bonnet upwards ⇒ fig. 251. This will release the arrester hook.
- Open the bonnet.

The bonnet is held open by two gas-filled struts.

#### ⚠ WARNING

**To avoid the risk of being scalded, never open the bonnet if you see steam or coolant escaping from the engine compartment. Wait until no steam or coolant can be seen before opening the bonnet. ■**



## Working on components in the engine compartment

*Extra caution is necessary when working on components in the engine compartment.*

Always be aware of the danger of injury and scalding as well as the risk of accident or fire when working in the engine compartment (e.g. when checking and refilling fluids). Always observe the warnings listed below and follow all normal safety precautions. The engine compartment of any motor vehicle is a potentially hazardous area. ⇒ .

### WARNING

- Switch off the engine.
- Remove the ignition key.
- Apply the parking brake.
- Put the gear lever in neutral or selector in P.
- Wait for the engine to cool down.
- Keep children away from engine compartment.
- Never spill fluids on hot engine components. These fluids can cause a fire (e.g. radiator anti-freeze).
- Take care not to cause short circuits in the electrical system, especially when working on the battery.
- Do not touch the radiator fan when the engine is hot. The fan may start running suddenly.
- Do not unscrew the cap on the expansion tank when the engine is hot. The cooling system is under pressure.
- Protect face, hands and arms by covering the cap with a large, thick rag to protect against escaping coolant and steam.
- If any tests have to be performed with the engine running, there is an extra safety risk from the rotating parts, such as the drive belts, alternator and radiator fan, etc., and from the high-voltage ignition system.

### WARNING (continued)

- **Vehicles with automatic gearbox:** Never open the throttle inadvertently (for instance by hand from the engine compartment) if a gear is engaged while the vehicle is stationary with the engine running. The vehicle could otherwise start moving immediately and possibly cause an accident.
- **Observe the following additional warnings if work on the fuel system or the electrical system is necessary:**
  - Always disconnect the battery.
  - Do not smoke.
  - Never work near naked flames.
  - Always keep an approved fire extinguisher immediately available.

### Caution

When topping up fluids make sure the correct fluid is put into the correct filler opening. This can otherwise cause serious malfunctions or engine damage.

### For the sake of the environment

Inspect the ground underneath your vehicle regularly so that any leaks are detected at an early stage. If you find oil spots or other fluids, have your vehicle inspected by a qualified workshop.

### Note

On right-hand drive vehicles\* some of the containers / reservoirs mentioned below are located on the other side of the engine compartment. ■

### Closing the bonnet

- To close the bonnet, pull it down to overcome the spring pressure.
- Then let it drop into the catches; *do not press down* ⇒ ⚠.

#### ⚠ WARNING

- For safety reasons the bonnet must always be completely closed when the vehicle is moving. After closing it always check that it is properly secured. The bonnet must be flush with the adjacent body panels.
- Should you notice that the bonnet is not safely secured when the vehicle is moving, stop the vehicle immediately and close the bonnet properly, otherwise it could cause an accident. ■

### Engine compartment layout

#### Engine compartment layout

Main components for checking and refilling

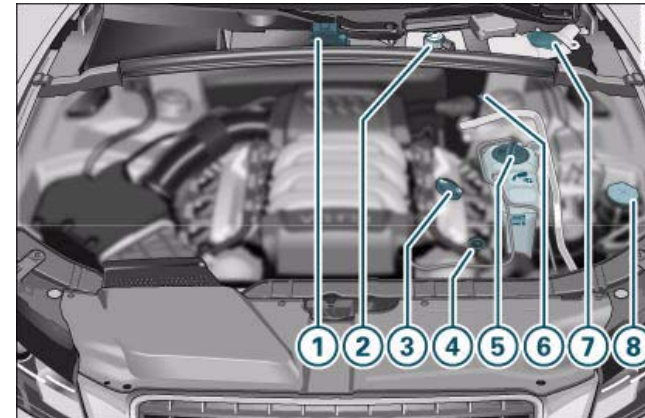

Fig. 252 Typical locations of fluid containers, engine oil dipstick and engine oil filler cap

① Jump-start terminal (+) under a cover	265, 294
② Brake fluid reservoir (☉)	262
③ Engine oil filler cap (🔑)	259
④ Engine oil dipstick* (orange)	258
⑤ Radiator expansion tank (♁)	261
⑥ Jump-start terminal (-) with hexagon head	265, 294
⑦ Windscreen washer container (🌀)	267
⑧ Hydraulic fluid reservoir for power steering	225 ▶

The positions of the engine oil filler cap and the engine oil dipstick ⇒ *page 256*, fig. 252 (items ③ and ④) may be different on some engine versions. ■

## Engine oil

### General notes

We recommend that you have the oil change carried out by an Audi dealership / qualified workshop according to the intervals stated in the Service Schedule or according to the service interval display in the instrument cluster.

Whether your vehicle is serviced at *flexible* service intervals or *fixed* service intervals is shown in the Service Schedule.

The correct oil specifications for your engine are listed in the **Technical data** section ⇒ *page 323*, "Performance, weights and dimensions".

Check that the specifications quoted (VW standards) appear on the container either singly or in combination with other specifications.

#### Flexible service intervals (Audi LongLife Service\*)

Special engine oils ⇒ *page 323*, "Performance, weights and dimensions" have been developed as part of the Audi LongLife Service (⇒ "Service Schedule").

This type of oil **must** be used if you intend to take advantage of the extended maintenance intervals allowed by the Audi LongLife Service.

- Do not mix the LongLife oil with oil intended for fixed service intervals, as the requirements for the extended service intervals are then no longer guaranteed.
- In exceptional circumstances, if the engine oil level is too low ⇒ *page 258* and you cannot obtain the specified LongLife oil, you can put in a small quantity of oil for **fixed service intervals** - ⇒ *page 323*, "Performance, weights and dimensions". This should

not be done more than once and no more than 0.5 litres should be used.

#### Fixed service intervals (Inspection Service)\*

If you do not take advantage of the LongLife service for your car, you can use the oils for **fixed service intervals** - ⇒ *page 323*, "Performance, weights and dimensions". In this case, your car must be serviced after a fixed interval of 1 year / 15,000 km (9,000 miles) - see Service Schedule.

- In exceptional circumstances, if the engine oil level is too low ⇒ *page 258* and you cannot obtain the oil specified for your vehicle, you can put in a small quantity of oil conforming to the specification ACEA A2 or ACEA A3 (petrol engines) or ACEA B3 or ACEA B4 (diesel engines). This should not be done more than once and no more than 0.5 litres should be used.

#### Vehicles with diesel particulate filter\*

The Service Schedule states whether your vehicle is fitted with a diesel particulate filter.

- Vehicles with diesel particulate filter must **only** be filled with engine oil **VW 507 00**. This oil can be used regardless of whether the vehicle is serviced at flexible service intervals (Audi LongLife Service) or fixed service intervals.
- Avoid mixing this oil with other engine oils.
- In exceptional circumstances, if the engine oil level is too low ⇒ *page 258* and you cannot obtain the oil specified for your vehicle, you can put in a small quantity of oil conforming to the specification VW 506 00 / VW 506 01 or VW 505 00 / VW 505 01 or ACEA B3 / ACEA B4. This should not be done more than once and no more than 0.5 litres should be used. ■

### Checking the oil level (with dipstick)

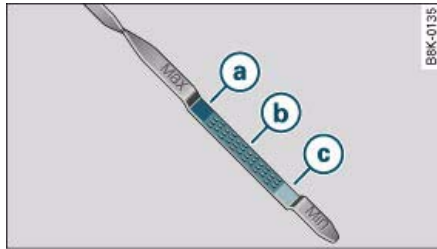

Fig. 253 Variant 1:  
Markings on oil  
dipstick

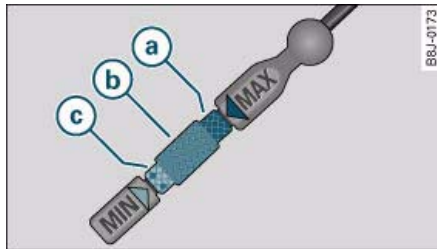

Fig. 254 Variant 2:  
Markings on oil  
dipstick

### Checking the oil level

- Park your vehicle on a level surface.
- Allow the warm engine to run briefly at idling speed and then switch off the ignition.
- Wait approx. 2 minutes.
- Pull out the dipstick. Wipe the dipstick with a clean cloth and insert it again, pushing it in as far as it will go.

- Then pull the dipstick out again and check the oil level ⇒ fig. 253 or ⇒ fig. 254. If the oil level is too low, add more engine oil ⇒ *page 259*.

#### Oil level in area **a**

- Do *not* top up oil.

#### Oil level in area **b**

- Oil *can* be topped up. *After topping up* the oil level should be in area **a**.

#### Oil level in area **c**

- Oil *must* be topped up. *After topping up* the oil level should be in area **a**.

Depending on how you drive and the conditions in which the car is used, oil consumption can be up to 0.5 ltr./1000 km. Oil consumption is likely to be higher for the first 5000 km. You should therefore check the oil level at regular intervals, ideally every time you fill the tank, and also before setting off on a long trip. ■

Applies to vehicles: without oil dipstick

### Checking the oil level (without dipstick)

You can check the engine oil level via the sound system or MMI\*.

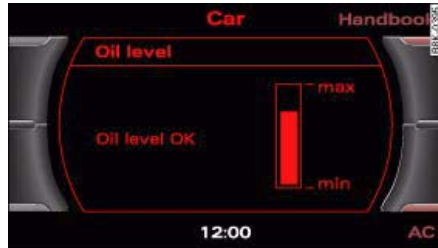

Fig. 255 Display: Oil level

- Select: Function selector button **CAR** > **Oil level**.
- Park your vehicle on a level surface.
- Allow the warm engine to run briefly at idling speed and then switch off the ignition.
- Wait approx. 2 minutes.
- Read off the oil level on the display ⇒ fig. 255. Top up the engine oil if the bar in the oil level display is near the "min" mark ⇒ *page 259*.

Depending on how you drive and the conditions in which the car is used, oil consumption can be up to 0.5 ltr./1000 km. Oil consumption is likely to be higher for the first 5000 km.

#### Note

The oil level display is intended solely for information purposes. An oil level warning will appear in the instrument cluster if the oil level is too low. Add more oil ⇒ *page 259*. If the bonnet has been opened,

the current oil level will be shown in the instrument cluster the next time the ignition is switched on. ■

### Topping up the engine oil

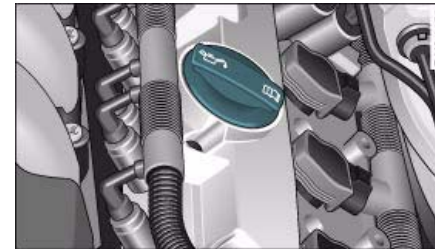



Fig. 256 Engine compartment: Engine oil filler cap

- Unscrew cap  from oil filler opening ⇒ fig. 256.
- Carefully put in the specified grade of oil ⇒ *page 323* 0.5 litres at a time.
- Check the oil level again after two minutes by calling up the sound system or MMI\* display or using the oil dipstick ⇒ *page 258*.
- If the oil level is too low, add more engine oil.
- Replace the oil filler cap carefully and push the dipstick all the way in (on vehicles with dipstick).

#### WARNING

- Ensure that no oil comes into contact with hot engine components when topping up: this could cause a fire.
- Wash your skin thoroughly if it comes into contact with engine oil.

**! Caution**

- The oil level must never be above area **a** ⇒ *page 258, fig. 254*, as this may result in damage to the catalytic converter or to the engine. On vehicles without an oil dipstick, you can check the oil level via the sound system or MMI\*. Contact a qualified workshop to extract the engine oil if necessary.
- No additives should be used with engine oil. Any damage caused by the use of such additives would not be covered by the factory warranty.

**✿ For the sake of the environment**

- Never pour oil down drains or into the ground.
- Always observe statutory requirements when disposing of empty oil canisters. ■

**Cooling system****Coolant**

*The purpose of the coolant is to carry heat away from the engine. The correct amount of anti-freeze is important to prevent the cooling system from freezing in winter.*

The cooling system is filled for life at the factory, so the coolant does not need to be changed. The coolant consists of a mixture of water and anti-freeze additive G12++. This is a glycol-based anti-freeze with anti-corrosion additives.

**Anti-freeze additive**

The amount of anti-freeze additive required depends on the temperatures to be expected in the winter season. If the anti-freeze concentration is too low the coolant can freeze, resulting in failure of the cooling system and heater.

The cooling system is filled at the factory with the correct amount of anti-freeze for the country concerned.

In most cases the mixture consists of 60% water and **40% additive**. This mixture gives the required anti-freeze protection at temperatures down to -25 °C and protects the alloy parts of the cooling system against corrosion. It also prevents scaling and raises the boiling point of the coolant.

**Countries with warm climate**

The coolant concentration must not be reduced by adding plain water, even in the summer or in warm climates. The concentration of the anti-freeze additive must always be **at least 40%**.

**Countries with cold climate**

If greater anti-freeze protection is required in very cold climates, the proportion of the anti-freeze additive G12++ can be increased. A concentration of 60% offers protection down to about -40 °C. The concentration of the anti-freeze additive must **not be more than 60%**, otherwise this would reduce the anti-freeze protection. In addition, the cooling effect will be adversely affected.

Vehicles for export to countries with a cold climate (such as Sweden, Norway and Finland) are supplied with antifreeze protection down to about -35 °C. The concentration of the antifreeze additive for these countries should always be at least 50%.

**! Caution**

- It is advisable to have the cooling system checked before the winter season to make sure that the antifreeze concentration is adequate for the conditions to be expected. This applies particularly if you intend to take the car into a colder climate zone. If necessary, have the anti-freeze concentration increased to 50 - 60% as required.
- Use only anti-freeze additive G12++, an additive meeting the specification "TL 774 G". Other additives may give considerably inferior corrosion protection. The resulting corrosion in the cooling system can lead to a loss of coolant, causing serious damage to the engine. ▶

- The coolant additive G12++ can be mixed only with additives G12+ and G12. ■

### Checking coolant level

The coolant level can be checked at a glance.

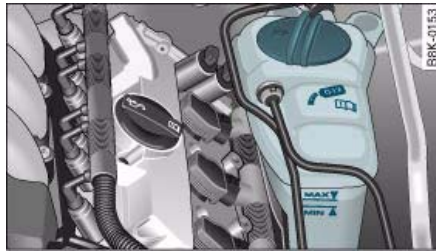

Fig. 257 Engine compartment: Markings on radiator expansion tank

- Switch off the ignition.
- Read off coolant level on radiator expansion tank ⇒ fig. 257. When the engine is cold it should be between the “MIN” and “MAX” marks. When the engine is hot it may be slightly above the “MAX” mark.

The coolant level should be checked with the engine switched off.

The coolant level is monitored by a warning lamp in the instrument cluster ⇒ page 33. However, we recommend that it should be checked occasionally.

#### Coolant losses

Any loss of coolant normally indicates a **leak** in the cooling system. In this case the cooling system should be inspected by a qualified workshop without delay. It is not sufficient merely to top up the coolant.

If there are **no leaks** in the system, a loss of coolant can only occur if the coolant boils and is forced out of the system as a result of overheating.

#### ⚠ Caution

Radiator sealants must not be added to the coolant. Such additives could seriously impair the function of the cooling system. ■

### Topping up the coolant

Be careful when topping up coolant.

- Switch off the engine.
- Wait for the engine to cool down.
- Cover the cap on the expansion tank ⇒ fig. 257 with a cloth, and **carefully** unscrew the cap anti-clockwise ⇒ ⚠.
- Add coolant.
- Screw the cap on again *tightly*.

Make sure that the coolant meets the required specifications ⇒ page 260, “Coolant”. Do not use a different type of additive if anti-freeze additive G12++, G12+ or G12 is not available. In this case use only water and bring the coolant concentration back up to the correct level as soon as possible by putting in the specified additive.

Always top up with *fresh, unused* coolant.

Do not fill above the “MAX” mark. Excess coolant is forced out of the system through the valve in the filler cap when the engine gets hot.

If a lot of coolant has been lost, wait for the engine to *cool down* before putting in cold coolant. Failure to do so could result in serious engine damage. ▶

**! WARNING**

- The cooling system is under pressure. Do not unscrew the cap on the expansion tank when the engine is hot: you could be scalded by escaping steam
- The coolant and coolant additive can be a health hazard. Store the coolant additive in the original container in a safe place out of reach of children – risk of poisoning.

**✿ For the sake of the environment**

Drained off coolant should not be used again. Drain off the used coolant into a suitable container and dispose of it in the proper manner (observe environmental regulations). ■

**Radiator fan**

*The radiator fan can start running spontaneously.*

The radiator fan is driven by the engine via a poly V-belt. The speed of the fan is varied by a viscous clutch according to the temperature.

There is also an auxiliary electric fan, which cuts in automatically whenever the temperature of the coolant and the engine compartment rises above a certain level.

The auxiliary fan can continue to run for as long as 10 minutes after stopping the engine – even after the ignition is switched off. It may also start running suddenly ⇒ **!** after a while if

- residual heat raises the coolant temperature, or
- the hot engine compartment is additionally heated up by the sun.

**! WARNING**

**When working in the engine compartment be aware that the radiator fan may start running suddenly – risk of injury. ■**

**Brake fluid****Checking brake fluid level**

*The brake fluid level can be checked at a glance.*



**Fig. 258 Engine compartment: Markings on brake fluid reservoir**

- Check the fluid level on the brake fluid reservoir ⇒ fig. 258. It should always be between the “MIN” and “MAX” marks.

In right-hand drive vehicles the brake fluid reservoir is on the other side of the engine compartment.

The fluid level may drop *slightly* after a period of time due to the automatic compensation for brake pad wear. This is quite normal.

However, if the level goes down noticeably in a *short* time, or drops below the “MIN” mark, there may be a leak in the brake system. If the fluid level in the reservoir is too low, this will be indicated by the brake warning lamp ⇒ *page 32*. If this should happen, **take the car to a qualified workshop immediately** and have the brake system inspected. ■



## Changing brake fluid

*When required, the brake fluid should be changed by a competent mechanic with the proper equipment.*

Brake fluid gradually absorbs moisture from the atmosphere. If the water content in the brake fluid is too high, this may cause corrosion in the brake system over time. In addition, the boiling point of the brake fluid will be considerably reduced. This could adversely affect the braking ability in certain circumstances.

For this reason the brake fluid must be changed periodically.

Your vehicle's Service Schedule will tell you when the brake fluid has to be changed.

It is advisable to have the brake fluid changed as part of a regular Inspection Service at your Audi workshop. They are familiar with the procedure and have the necessary special tools and spare parts as well as the proper facilities for disposing of the old fluid.

Use only the genuine brake fluid specified by the factory. Qualified workshops know that the brake fluid "DOT 4" is approved by Audi. The brake fluid must be fresh and unused.

### WARNING

- **Brake fluid is poisonous; store it in the sealed original container in a safe place out of reach of children.**
- **Heavy use of the brakes may cause a vapour lock if the brake fluid is left in the system for too long. This would seriously affect the efficiency of the brakes and the safety of the car – risk of accident.**

### Caution

Please note that brake fluid will attack the paintwork on contact.

### For the sake of the environment

If the fluid has to be drained out of the brake system, use an appropriate container to catch the used brake fluid and dispose of it in the proper manner. ■

## Battery

### General notes

*All work on batteries requires specialist knowledge.*

The battery is virtually **maintenance-free**. It is checked as part of the Inspection Service.

We recommend that you replace a battery once it is older than 5 years.

When an airbag is triggered, the battery will, under certain circumstances, be disconnected from the on-board power supply for safety reasons ⇒  in "General notes on airbag system" on page 201.

### Disconnecting the battery

If the battery is disconnected, some of the vehicle's functions will become inoperative (e.g. electric windows). These functions will require resetting after the battery is reconnected. For this reason, the battery should only be disconnected from the vehicle's electrical system when absolutely necessary.

### If the vehicle is not used for long periods

If you do not drive your vehicle for a period of several days or weeks, the power management will gradually shut off the on-board systems one by one, or reduce the amount of current they are using. This limits the amount of power consumed and helps to ensure reliable starting even after a long period ⇒ page 226. ▶

Please note that certain convenience features, such as the Audi advanced key\*, the remote control key or the electrical seat adjustment may not be available when you unlock the vehicle. These functions will be restored when you switch on the ignition and start the engine.

#### Winter conditions

**At low temperatures** the battery has to work very hard. It also provides only a fraction of the starting power it has at normal temperatures.

For this reason, we recommend having the battery checked and charged if necessary before the start of winter ⇒ *page 265*.

#### WARNING

- **All work on batteries requires specialist knowledge. For queries regarding the vehicle battery please contact an Audi dealership or other qualified workshop (risk of chemical burns / risk of explosion).**
- **The battery must not be opened. Do not attempt to make any changes to the electrolyte level of the battery. Otherwise, there is a risk that a mixture of oxygen and hydrogen gas can accumulate and cause an explosion.**





#### Note

If the vehicle is to be left standing for a period of several weeks at extremely low temperatures, the battery should be removed from the vehicle. This ensures that it cannot “freeze up” and be damaged. ■

### Important safety warnings for handling a car battery

*All work on batteries requires specialist knowledge.*

The vehicle battery is located under the floor panel in the luggage compartment.

	Wear safety glasses!
	Battery acid is extremely corrosive. Wear protective gloves and safety glasses.
	Keep open flames, sparks, uncovered lights and lit cigarettes away from battery!
	A highly explosive mixture of gases is given off when the battery is under charge!
	Keep children away from the battery and battery acid.

#### WARNING

**Always be aware of the danger of injury and chemical burns as well as the risk of accident or fire when working on the battery and the electrical system.**

- **Wear safety glasses. Do not allow acid or lead particles to come into contact with eyes, skin or clothing.**
- **Battery acid is extremely corrosive. Wear protective gloves and safety glasses. Do not tilt the battery - acid can leak out of the vapour vent. If electrolyte should splash into the eyes rinse at once for several minutes using clear water. Then seek medical care immediately. Neutralize any acid splashes on the skin or clothing with soap solution, and rinse off with plenty of water. If acid is swallowed by mistake, consult a doctor immediately.**
- **Keep open flames, sparks, uncovered lights and lit cigarettes away from battery. Avoid sparks (including those from static**

**⚠ WARNING (continued)**

charges) when handling cables and electrical equipment. Never cross the battery poles. The resulting high-energy sparks can cause injury.

- A highly explosive mixture of gases is given off when the battery is under charge. Only charge battery in a well ventilated area.
- Keep children away from the battery and battery acid.
- Switch off all electrical equipment before starting any work on the vehicle electrical system. Remove the ignition key. The minus cable of the battery must be disconnected. When changing a light bulb, it is sufficient to only turn off the light.
- Before disconnecting the battery, turn off the anti-theft system! Otherwise, the alarm will sound.
- When disconnecting the battery from the vehicle's electrical system, first disconnect the minus cable and then the plus cable.
- Before reconnecting the battery, turn off all electrical equipment. First connect the plus cable, then the minus cable. The battery cables must not be connected to the wrong battery poles - serious risk of cable fire.
- Never charge a frozen or thawed out battery - risk of explosion and chemical burns! A battery must be replaced once it has been frozen. When it is discharged the battery can freeze at temperatures around 0°C.
- Make sure that the vapour hose is always attached to the battery.
- Never use a damaged battery - risk of explosion! Replace a damaged battery immediately.

**⚠ Caution**

- Never disconnect the car's battery with the engine running or with the ignition turned on, otherwise the electrical system or electrical components will be damaged.

- Do not expose the battery to direct sunlight over a long period of time, as the intense ultraviolet radiation can affect the battery housing.
- If the car is left standing for long periods, protect the battery from extreme cold temperature so that it does not "freeze up" and become damaged. ■

**Charging the battery**

*Terminals for charging the battery are fitted in the engine compartment.*

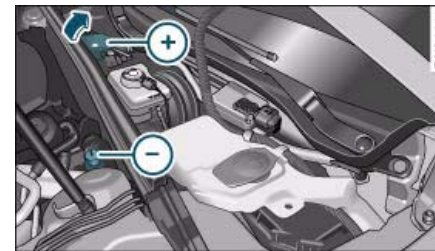



Fig. 259 Engine compartment: Terminals for jump leads and battery charger

- Note the warnings ⇒ ⚠ in "Important safety warnings for handling a car battery" on page 264 and ⇒ ⚠.
- Switch off all electrical equipment. Remove the ignition key.
- Open the bonnet ⇒ page 254.
- Open the red cap on the positive terminal ⇒ fig. 259.
- Follow the correct procedure for connecting the charger cables to the **jump-start terminals** (terminal with red cap = "positive", terminal with hexagon = "negative"). ▶

- Now connect the battery charger to the mains and switch on.
- After charging the battery: switch off the battery charger and disconnect the mains cable.
- Now disconnect the charger cables.
- Refit the red cap onto the positive terminal.
- Close the bonnet ⇒ *page 256*.

When it is discharged the battery can **freeze** at temperatures around 0°C. A frozen battery must be thawed before charging ⇒ . However, it is advisable to replace the battery if it has frozen, because the ice can crack the battery casing and allow the battery acid to escape.

#### Charging the battery

Important: Before you charge the battery make sure you read the manufacturer's instructions for using the battery charger.

When charging with a *low* current (for instance with a **small battery charger**) the battery does not have to be disconnected. The battery must not be opened while you are charging it.

#### Fast-charging the battery

For technical reasons it is **not** permissible to *fast-charge* the battery using charging devices with an output voltage higher than 14.8 V.

#### WARNING

Never charge a frozen battery – it could explode.

#### Note

Use only the terminals in the engine compartment to charge the battery. ■

#### Replacing the battery

*A replacement battery must have the same specifications as the original equipment battery.*

Your vehicle is equipped with an intelligent power management system to control the distribution of electrical energy ⇒ *page 226*. The power management function ensures that the battery is charged much more efficiently than on vehicles without a power management system. For this additional power to be available after replacing the battery, we recommend that the replacement battery used is of the same make and type as the original-equipment battery. The battery must be encoded in the control unit for power management. This has to be done by a qualified workshop.

A replacement battery must have the same capacity, voltage (12 V) and current rating. It must also have the same dimensions as the original, factory-fitted battery and have sealed caps. The battery must comply with the standards TL 825 06 (dated December 1997 or later) and VW 7 50 73 (August 2001 or later).

#### Caution

- Make sure that the vent hose is always attached to the opening on the side of the battery. Gases or battery acid can otherwise escape and possibly cause damage.
- The battery holder and clamps must always be correctly secured.
- Before starting any work on the battery, always observe the warnings listed under ⇒ *page 264*, "Important safety warnings for handling a car battery".

#### For the sake of the environment

 Batteries contain toxic substances including sulphuric acid and lead. They must be disposed of appropriately and must not be put together with ordinary household waste. Make sure the battery removed from the vehicle cannot tip over. Otherwise, sulphuric acid could escape. ■

## Windscreen washer

*Plain water on its own is not sufficient for the windscreen washer system.*

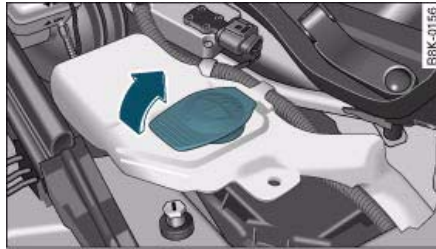

**Fig. 260 Engine compartment: Windscreen washer container**

The container for the windscreen washer  contains the cleaning fluid for the windscreen and the headlight washer system\*  
⇒ fig. 260. Container capacity: ⇒ *page 321*.

Plain water on its own is not enough to clean the glass properly. It is therefore advisable to add a suitable washer fluid additive (with wax solvent) to the water. A washer fluid with freeze-resistant additive should be used in winter.

### **Caution**

- Never put in radiator anti-freeze or other additives.
- Never use washer fluid which contains paint thinners or solvents as it can damage the paintwork. ■

## Wheels and tyres

### Wheels

#### General notes

- When driving with **new tyres**, be especially careful during the first 500 km.
- If you have to drive over a kerb or similar obstacle, drive very slowly and as near as possible at a right angle to the kerb.
- Inspect the tyres regularly for damage (cuts, cracks or blisters, etc.). Remove any foreign bodies embedded in the treads.
- Damaged wheels and tyres must be replaced immediately.
- Keep grease, oil and fuel off the tyres.
- Replace any missing valve caps as soon as possible.
- Mark the wheels before taking them off so that they rotate in the same direction when put back.
- When removed, the wheels or tyres should be stored in a cool, dry and preferably dark place.

#### New tyres

New tyres do not give maximum **grip** straight away and should therefore be “run in” by driving carefully and at moderate speeds for about the first 500 km. This will also help to make the tyres last longer.

The **tread depth** of new tyres may *vary*, according to the type and make of tyre and the tread pattern.

#### Concealed damage

Damage to tyres and rims is often not readily visible. If you notice unusual **vibration** or the car **pulling to one side**, this may indicate that one of the tyres is damaged. Reduce speed immediately if there is any reason to suspect that damage may have occurred. Inspect the tyres for damage. If no external damage is visible, drive slowly and carefully to the nearest qualified workshop and have the car inspected.

#### Tyres with directional tread pattern

An arrow on the tyre sidewall indicates the direction of rotation on tyres with directional tread. Always note the direction of rotation indicated when mounting the wheel. This guarantees optimum grip and helps to avoid aquaplaning, excessive noise and wear. ■

#### Tyre service life

*Correct inflation pressures and sensible driving habits will increase the service life of your tyres.*



Fig. 261 Open driver's door (LHD vehicle) with sticker listing tyre inflation pressures

- Check the tyre pressures at least once a month. ►



- The tyre pressures should only be checked when the tyres are *cold*. The slightly raised pressures of warm tyres must not be reduced.
- The pressures must be altered to suit major changes in the load being carried.
- Avoid fast cornering and hard acceleration.
- Inspect the tyres for irregular wear from time to time.

**Tyre pressure and vehicle loading**

The tyre pressure must be adjusted according to the load the vehicle is carrying. We recommend adhering to the tyre pressure specifications for a maximum load. The tyre inflation pressures are listed on a sticker on the end face of the driver's door => *page 268*, fig. 261.

However, if you prefer an extra-smooth ride and the vehicle is not fully loaded, you can select the tyre pressure for a normal load (no more than three people travelling in the vehicle). However, should you wish to drive with a full load you **must** increase the tyre pressure to the specified maximum.

Under-inflation or over-inflation will reduce the life of the tyres considerably and also impair the car's handling. Correct inflation pressures are very important, especially at **high speeds**. The pressures should therefore be checked at least once a month and before starting a journey.

Do not forget the spare wheel\* when checking the tyre pressures. Keep the spare tyre inflated to the highest pressure required for the road wheels.

**Driving habits**

Fast cornering, heavy acceleration and hard braking (squealing tyres) all increase tyre wear.

**Wheel balancing**

The wheels on new vehicles are balanced. However, various factors encountered in normal driving can cause them to become unbalanced, which results in steering vibration.

Unbalanced wheels should be rebalanced, as they otherwise cause excessive wear on steering, suspension and tyres. A wheel must also be rebalanced when a new tyre is fitted or if a tyre is repaired.

**Incorrect wheel alignment**

Incorrect wheel alignment causes excessive tyre wear, impairing the safety of the vehicle. If you notice excessive tyre wear, contact your Audi dealer.

**WARNING**

- Always adapt the tyre pressure accordingly when the vehicle load changes.
- Under-inflated tyres flex more and can overheat at continuous high speeds. This can cause tread separation and tyre blow-out, which could result in an accident.

**For the sake of the environment**

Under-inflated tyres will increase the fuel consumption. ■

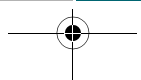
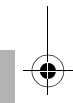
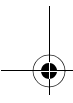
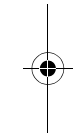
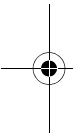

### Tread wear indicators

The tread wear indicators show the condition of the tyre treads.

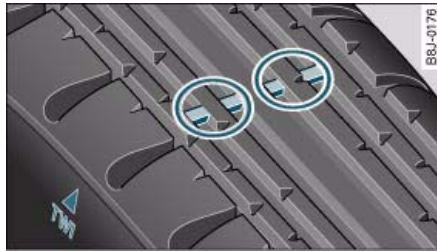

Fig. 262 Tyre tread:  
Tread wear indicators

The original tyres on your vehicle have 1.6 mm high “tread wear indicators” ⇒ fig. 262 running across the tread. Depending on the make, there will be 6 to 8 of them spaced at equal distances around the tyre. Markings on the tyre sidewall (for instance the letters “TWI” or a triangle) indicate the positions of the tread wear indicators.

The minimum tread depth required by law in Germany is 1.6 mm (measured in the tread grooves next to the tread wear indicators). Other specifications may apply in export countries.

#### WARNING

To avoid putting safety at risk, the tyres must be replaced at the latest when the tread is worn down to the tread wear indicators.

- Especially in difficult driving conditions such as wet or icy roads, it is important that the tyres have sufficient tread depth. The tread depth should be the same on the tyres of both the front and the rear axles.
- The decrease in driving safety due to insufficient tread depth is particularly evident in vehicle handling, when there is a risk of

#### WARNING (continued)

aquaplaning in deep puddles of water and when driving through corners. Braking is also adversely affected.

- The speed has to be adapted accordingly, otherwise there is a risk of losing control over the vehicle. ■

### Changing wheels round

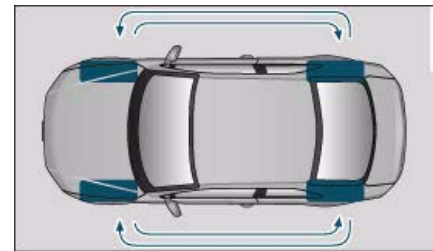

Fig. 263 Changing  
wheels round

To ensure that the wear is equal on all tyres the wheels should be changed round from time to time according to the system ⇒ fig. 263. All the tyres will then last for about the same time. ■

### Replacing wheels and tyres

It is important to use the correct wheels and tyres when replacement is necessary.

- All four wheels must be fitted with tyres of the same type, size (rolling circumference) and preferably the same tread pattern.
- If possible, tyres should be replaced at least in pairs and not individually (i.e. both front tyres or both rear tyres together).



- Never use tyres whose actual size exceeds the dimensions of the factory-approved makes of tyre.
- If you wish to fit the vehicle with non-standard rims or tyres, it is advisable to consult an Audi dealer **before** purchasing them.

The tyres and wheel rims are an essential part of the vehicle's design. The tyres and rims approved by Audi are specially matched to the characteristics of the vehicle and make a major contribution to good roadholding and safe handling ⇒ ⚠.

The sizes of the rims and tyres approved for your vehicle are listed in the vehicle's documents (e.g. EC Certificate of Conformity or COC document <sup>3)</sup>). The vehicle documents vary depending on the country of residence.

Understanding the tyre designations makes it easier to choose the correct tyres. For example, radial ply tyres have the following **tyre designations** marked on the sidewall:

**225 / 50 R 17 94 Y**

This contains the following information:

225	Tyre width in mm
50	Height/width ratio in %
R	Tyre construction: <b>Radial</b>
17	Rim diameter in inches
94	Load rating code
Y	Speed rating code letter

The **manufacturing date** is also indicated on the tyre sidewall (possibly only on the *inner* side of the wheel):

**DOT ... 1006...**

<sup>3)</sup> COC = certificate of conformity

means, for example, that the tyre was produced in the 10th week of 2006.

**Please note that with some types of tyres, the actual tyre size can differ from the nominal size marked on the tyre (for instance 225/50 R 17 94 Y), and there may be significant differences in the contours of the tyres, even though the tyres are marked with the same nominal size designation. When replacing the tyres, it is therefore important to make sure that the actual size of the new tyres does not exceed the dimensions of the factory-approved makes of tyre.**

**Failure to observe this requirement can affect the clearance needed for the tyres. This could result in contact between the tyres and suspension components or bodywork. The brake lines could also be damaged and the vehicle's safety could be severely impaired ⇒ ⚠. When using tyres with the maximum permitted nominal dimensions, this can also void the vehicle's registration.**

**If you use tyres that are approved by Audi you can be sure that the actual tyre dimensions will be correct for your vehicle. If you decide to fit a different type of tyre, you must obtain the appropriate manufacturer's certificate from the tyre retailer to confirm that the tyres are suitable for your vehicle. Keep this certificate in a safe place.**

**Your local Audi dealer will be able to advise you on which tyres may be fitted to your vehicle.**

On vehicles with **four-wheel drive**, all four tyres must always be fitted with tyres of the same type, make and tread pattern, as otherwise the driveline can be damaged by continuous variations in the wheel speeds. For the same reason, only use a spare wheel\* with the same tyre dimensions as the normal road wheels.

It the **spare tyre\*** is not the same type as the tyres fitted on the car (for example if the car has winter tyres or wide-section tyres) you should only use the spare tyre if a puncture occurs, and then only for a short period of time. In this case, please drive with extra care. Refit the normal road wheel as soon as possible.

It is best to have all servicing of wheels and tyres performed by a **qualified workshop**. They have the necessary special tools and ▶

replacement parts, trained personnel and facilities for disposing of the old tyres.



#### WARNING

- It is very important to ensure that the tyres you have chosen have adequate clearance. When selecting replacement tyres, do not rely entirely on the nominal tyre size marked on the tyre; with some makes of tyre the effective tyre size can differ significantly from the nominal dimensions, even though the tyres have the same size designation. Inadequate tyre clearance can result in damage to the tyres or the vehicle, causing a serious safety risk. It may also invalidate the vehicle's type approval for use on public roads.
- Please ask your Audi dealer or qualified workshop whether run flat tyres can be used on your vehicle. Unauthorised use of these tyres can invalidate the vehicle's type approval for use on public roads. Furthermore, this could cause damage to your vehicle and possibly also result in an accident.
- Avoid running the car on tyres that are more than 6 years old. If you have no alternative, you should drive slowly and with extra care at all times.



#### For the sake of the environment

Old tyres must be disposed of according to the laws in the country concerned.



#### Note

- Never mount used tyres if you are not sure of their previous history.
- For technical reasons it is not normally possible to use wheel rims from other vehicles. In some cases this also applies to rims from other vehicles of the same model. ■

### Wheel bolts

*The wheel bolts are designed to suit the rims on your car.*

The **wheel bolts** are matched to the rims. When installing different wheels (for instance wheels with winter tyres) it is important to use the correct wheel bolts with the right length and correctly shaped bolt heads. This is essential for the secure fit of the wheels and for the proper function of the brake system.

Audi dealers have full information on the technical requirements when installing or changing tyres, rims or wheel trims.

The wheel bolts should be clean and turn easily.

A special adapter is required to turn the anti-theft wheel bolts\*  
⇒ page 292. ■

### Winter tyres

*Winter tyres will significantly improve the car's handling in winter road conditions.*

- Use only **radial ply** winter tyres.
- Winter tyres must be fitted **on all four** wheels.
- Only use winter tyres of the correct type approved for your vehicle.
- Please note that the maximum permissible speed for winter tyres may be lower than for summer tyres.
- Also note that winter tyres are no longer effective when the **tread** is worn down.
- After fitting the wheels you must always check the tyre pressures. The correct tyre pressures are listed on the sticker on the end face of the driver's door. ▶

In winter road conditions winter tyres will considerably improve the car's handling. Due to their type of construction (width, rubber compound, tread pattern), summer tyres give less grip on ice and snow. This applies particularly to vehicles equipped with **wide section tyres** or **high speed tyres** (code letters H, V or Y on the sidewall).

Only use winter tyres of the correct type approved for your vehicle. The sizes of the winter tyres approved for your vehicle are listed in the vehicle's documents (e.g. EC Certificate of Conformity or COC document <sup>4)</sup>). The vehicle documents vary depending on the country of residence. Also refer to ⇒ *page 270*, ⇒ *page 270*.

Winter tyres are no longer fully effective when the **tread** is worn down to a depth of 4 mm.

The performance of winter tyres is also severely impaired by **ageing**, even if the tread is still much deeper than 4 mm.

Winter tyres are subject to the following **maximum speed limits** according to speed rating code letter: ⇒ 

Speed rating code letter ⇒ <i>page 270</i> , ⇒ <i>page 270</i>	Maximum speed limit
Q	160 km/h
S	180 km/h
T	190 km/h
H	210 km/h
V	240 km/h (note restrictions)

In Germany vehicles capable of exceeding these speeds must have an appropriate **sticker** attached so it is visible to the driver. Suitable stickers are available from Audi dealers and specialist retailers. Please note regulations to this effect in your country.

<sup>4)</sup> COC = certificate of conformity

"All-weather" tyres can also be used instead of winter tyres.

#### Using winter tyres with V-rating

Please note that the generally applicable 240 km/h speed rating for winter tyres with the letter "V" is subject to **technical restrictions; the maximum permissible speed for your vehicle may be significantly lower**. The maximum speed limit for tyres with a V-rating depends directly on the maximum axle weights for your car and on the listed weight rating of the tyres being used.

It is best to contact an Audi dealer to check the maximum speed which is permissible for the V-rated tyres fitted on your car on the basis of this information.

#### WARNING

**Exceeding the maximum speed permitted for the winter tyres fitted on your car can cause tyre failure, resulting in a loss of control of the vehicle – risk of accident.**

#### For the sake of the environment

Summer tyres should be fitted again as soon as possible; they give better handling on roads which are free of snow and ice. Summer tyres produce less rolling noise, do not wear down as quickly and, most importantly, reduce fuel consumption. ■

#### Snow chains

*Snow chains will improve the vehicle's handling on snow-covered roads.*

- Snow chains can be used on the *front* wheels only.
- Keep your speed below 50 km/h.

Snow chains will improve *braking ability* as well as *traction* in winter conditions. ▶

For technical reasons snow chains may only be used on tyres with certain wheel rim/tyre combinations.

Rim size	Rim offset	Tyre size
7Jx16	39 mm	205/60
7Jx16	46 mm	225/55
7Jx17	46 mm	225/50

Only use snow chains with **fine-pitch links**. The links must not protrude more than 13.5 mm from the tyres (including tensioner).

Remove the chains when roads are *free of snow*. Otherwise they will impair handling, damage the tyres and wear out very quickly.

**Four-wheel drive:** where snow chains are compulsory on certain roads, this normally also applies to cars with four-wheel drive. Snow chains may only be fitted to the *front* wheels (also on vehicles with four-wheel drive). ■

## Run flat tyres

Applies to vehicles: with run flat tyres

### Introduction

*Run flat tyres allow you to continue your journey in the event of a loss of tyre pressure.*

Run flat tyres have reinforced sidewalls which support the tyre in the event of a loss of pressure.

Run flat tyres must only be used on vehicles which were already factory-fitted with these tyres and which also have a tyre pressure monitoring system\*.

**Run flat tyres** can be identified by the marking "RSC" (Runflat System Component) on the **sidewall**.

If you change the tyres on your vehicle from regular tyres to run flat tyres or vice-versa, the control unit must be reprogrammed by an Audi dealer or other qualified workshop.

### What are the benefits of run flat tyres?

Run flat tyres ensure that you remain mobile, even in the event of a loss of tyre pressure. In favourable conditions these tyres have an operating range of **at least 30 km**, however the vehicle **must not be driven faster than 80 km/h** ⇒ ⚠ in "Driving with run flat tyres" on page 275.

The tyre pressures are constantly checked by the tyre pressure monitoring system. When the run flat system becomes active (centre display), it is still the driver's responsibility to check the tyre(s) affected and to decide whether it is possible to continue driving. Also refer to ⇒ page 275, "Driving with run flat tyres".

### When is it no longer possible to continue driving with the help of the run flat tyres?

- If the Electronic Stabilisation Program (ESP) is out of operation or is triggered continuously.
- If the tyre pressure monitoring system is out of operation.
- If one of the tyres has been severely damaged in an accident, etc. If a tyre has been badly damaged there is a risk that parts of the tread can be thrown off and cause damage to the fuel lines, brake pipes or fuel filler.
- You must stop driving if severe vibrations occur, or if the wheel starts overheating and gives off smoke.
- You must also stop driving if damage to the tyres (e.g. tears in the sidewalls) becomes apparent.

### ⚠ WARNING

**Please ask your Audi dealer or qualified workshop whether run flat tyres can be used on your vehicle. Unauthorised use of these tyres can invalidate the vehicle's type approval for use on public roads.** ▶

**⚠ WARNING (continued)**

Furthermore, this could cause damage to your vehicle and possibly also result in an accident.

**Note**

- If you cannot continue driving even with run flat tyres please obtain professional assistance.
- You should obtain professional assistance if you are in any doubt regarding the rims and tyres for your vehicle. ■

Applies to vehicles: with run flat tyres

**Driving with run flat tyres**

*Please remember that the vehicle's handling will be impaired.*

Driving a vehicle with a deflated tyre, or with insufficient tyre pressure, is an abnormal situation. However, since the handling of a vehicle equipped with run flat tyres is only slightly impaired, it is important to remember that you are driving with a deflated tyre. If you have to make use of the run flat system please remember the following points:

- The Electronic Stabilisation Program (ESP) must be switched on.
- Do not exceed 80 km/h ⇒
- Anticipate the traffic situation well in advance.
- Be careful when accelerating.
- Avoid unnecessary braking and steering manoeuvres.
- Reduce speed in good time before corners and potential hazards.

Please refer to ⇒ *page 274*, “When is it no longer possible to continue driving with the help of the run flat tyres?”

**Effects on handling when driving with defective tyres**

If one of the **front tyres is defective**, your vehicle will tend to pull slightly towards that side and braking performance will be impaired.

A **defective rear tyre** will also make the vehicle pull slightly to one side, and the braking response will again be slightly impaired. These effects will be most noticeable when driving in a corner.

**WARNING**

- **When using the run flat system the changes in vehicle handling will be noticeable when braking, in corners and during fast acceleration.**
- **The maximum permitted speed of 80 km/h is subject to road and weather conditions. Always observe the relevant rules and regulations. Run flat tyres allow you to continue your journey in the event of a loss of tyre pressure. However, the driver remains responsible for the safety of the vehicle and for restoring the correct tyre pressure and having defective parts replaced ⇒ *page 276*. For these reasons you should always adjust your driving to suit the circumstances.**

**Caution**

We recommend that you drive with great care when making use of the run flat system. Avoid abrupt manoeuvres. ■

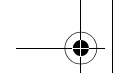

Applies to vehicles: with run flat tyres

### Renewing defective components on run flat tyres

*The run flat tyres have been specially developed for your vehicle and matched to its requirements.*

Use and combine only the approved run flat tyres and rims. It is not permissible to combine standard wheels and run flat tyres ⇒ ⚠.

If you have to drive with low tyre pressure or with a completely deflated tyre, you should always take the vehicle to an authorised qualified workshop and have the defective parts inspected and the condition corrected.



#### WARNING

- We recommend that you have the run flat tyre renewed and also have the rim checked by a qualified workshop to identify any damage.
- Using tyres or rims which have not been approved can cause damage to the vehicle. Vehicle handling can be impaired and driving safety can no longer be guaranteed. This can also void the vehicle's certification for use on public roads.



#### Note

Run-flat tyres can be repaired with the TMS ⇒ page 285. ■

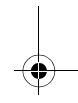
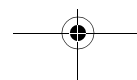
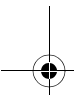
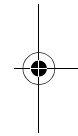
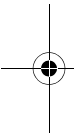

## Accessories and modifications to the vehicle

### Accessories and replacement parts

*Always ask your dealer or specialist retailer for advice before purchasing accessories and replacement parts.*

Your car is designed to offer a high standard of active and passive safety. For this reason, we recommend that you ask an Audi dealer for advice before fitting accessories or replacement parts. Audi dealers have the latest information from the manufacturer and can recommend accessories and replacement parts which are suitable for your requirements. They can also answer any questions you might have regarding official regulations.

We recommend you to use only **Audi accessories** and **Audi Genuine parts**<sup>®</sup>. Audi has tested these parts and accessories for suitability, reliability and safety. Audi dealers have the necessary experience and facilities to ensure that the parts are installed properly.

Although the market is constantly scrutinised, Audi cannot judge or assume responsibility for the reliability, safety and suitability of non-genuine products - even though in some instances, these parts may have been approved by an officially recognised technical testing authority or accompanied by an official approval certificate.

Any **retro-fitted equipment** which has a direct effect on the vehicle and/or the way it is driven (e.g. cruise control system or electronically-controlled suspension) must be approved for use in your vehicle and bear the **e** mark (the European Union's approval symbol).

If any **additional electrical components** are fitted which do not serve to control the vehicle itself (for instance a refrigerator box, laptop or ventilator fan, etc.), these must bear the **CE** mark (manufacturer conformity declaration in the European Union).

#### WARNING

**Never attach accessories (such as cup holders or telephone brackets) to the surfaces covering the airbag units or the areas around the airbags: this could cause injury if the airbag is triggered. ■**

### Modifications

*Modifications must always be carried out according to our specifications.*

Unauthorised modifications to the electronic components or software in the vehicle may cause malfunctioning. Due to the way the electronic components are linked together in networks, other systems may be affected by the faults. This can seriously impair safety, lead to excessive wear of components, and also invalidate the type approval for your vehicle.

You will appreciate that your Audi dealer cannot be held liable for any damage caused by modifications and/or work performed incorrectly.

We recommend that all work should be performed by an Audi workshop using **Audi Genuine parts**<sup>®</sup>.

#### WARNING

**Incorrectly performed modifications or other work on your vehicle can lead to malfunctions and cause accidents. ■**

Controls

Safety

Driving tips

General maintenance

Self-help

Technical data

## Radio transmitters and business equipment

### Radio transmitters (fixed installation)

Retrofit installations of radio transmitters in the vehicle are subject to official approval. Audi generally authorises in-vehicle installations of approved types of radio transmitters provided that:

- the aerial is installed correctly,
- the aerial is not installed in the interior of the vehicle (and screened cables are used together with non-reflective aerial trimming),
- the effective transmitting power does not exceed 10 Watts at the aerial base.

Audi dealers and specialist retailers will be able to inform you about options for installing and operating radio transmitters with a *higher* transmitting power.

### Mobile radio transmitters

When using commercial mobile telephones or radio equipment it is possible that they might interfere with the electronics of your vehicle and cause malfunctions. The reasons could be:

- no external aerial
- external aerial incorrectly installed
- transmitting power more than 10 W.

Therefore you must not operate portable mobile telephones or radio equipment *inside the vehicle* without a correctly installed external aerial ⇒ .

Please note also that the maximum range of the equipment can only be achieved with an *external* aerial.

### Business equipment

Retrofit installation of business or other equipment in the vehicle is permitted, provided the equipment cannot interfere with the

driver's immediate control of the vehicle. Any such equipment must carry the **CE mark**. Any retrofit equipment that could influence the driver's control of the vehicle must have a type approval for your vehicle and must carry the **e mark**.

### WARNING

**Mobile telephones or radio equipment which are operated inside the vehicle without a correctly installed external aerial can create excessive magnetic fields that could cause a health hazard.**

### Note

- Any retrofit installation of electrical or electronic equipment in the vehicle will affect its type approval. In extreme cases this could mean that you might lose the type approval for your vehicle.
- Please refer to the mobile telephone/radio operating instructions. ■



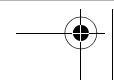
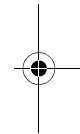
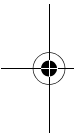
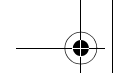

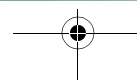
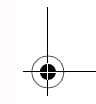
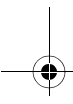
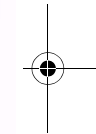
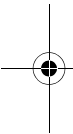

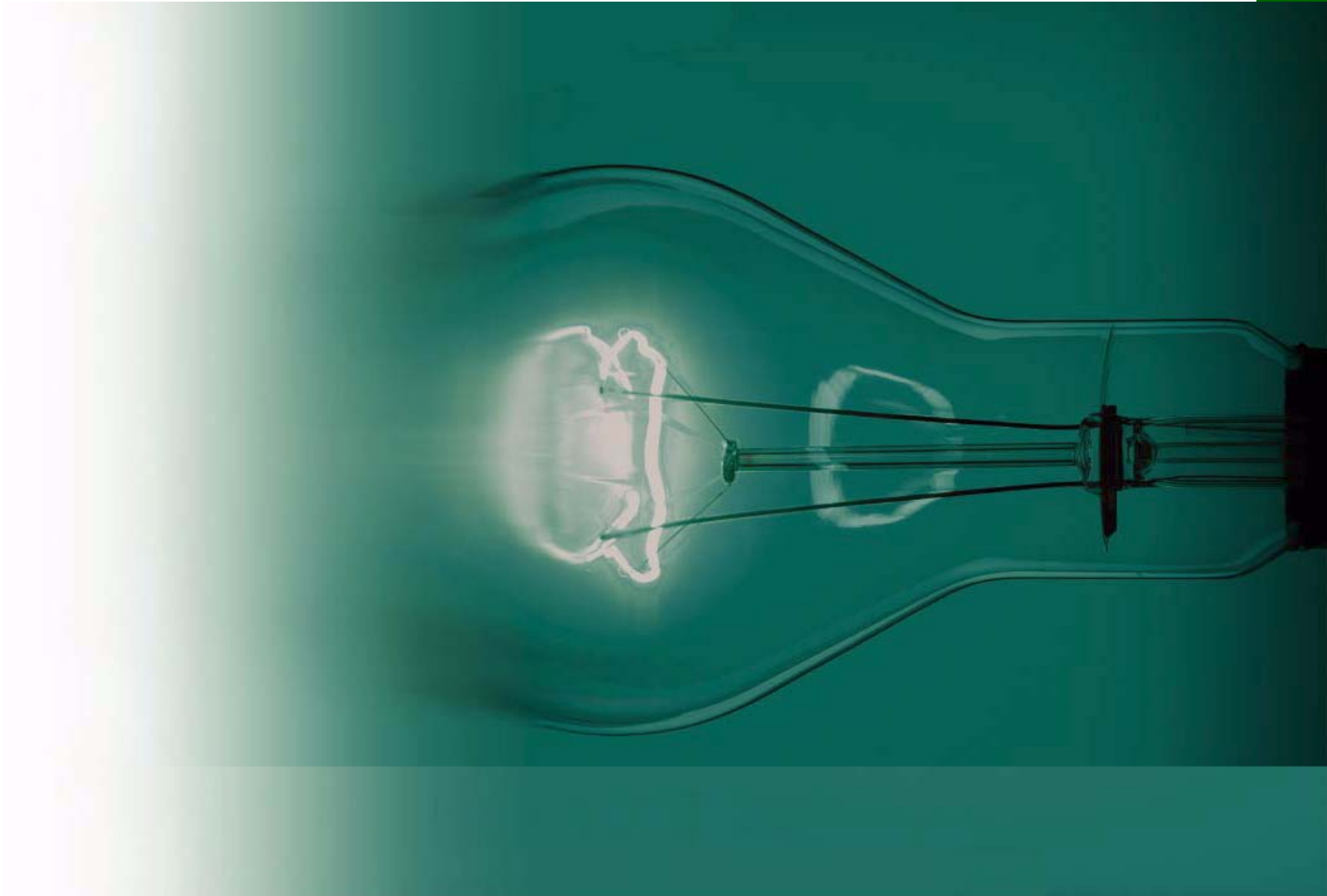
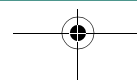
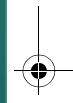
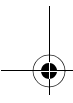
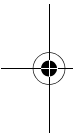

## Self-help

Applies to vehicles: with warning triangle

### Warning triangle

*The factory-supplied warning triangle is attached to the inside of the boot lid.*

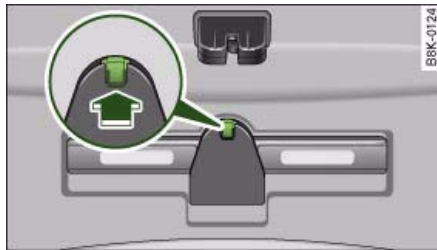

**Fig. 264** Warning triangle fitted inside boot lid

- To remove the warning triangle, push the tab in the direction indicated by the arrow ⇒ fig. 264 and pull the retainer down.

The retainer on the boot lid is specifically designed to hold the warning triangle supplied as an Audi Genuine Accessory. This accessory is available from Audi dealers. ■

Applies to vehicles: with first-aid kit

### First-aid kit

*The first-aid kit is accommodated in the compartment behind the rear centre armrest.*

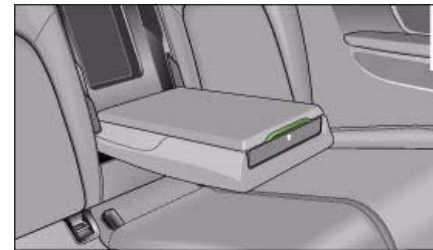

**Fig. 265** Rear centre armrest: First-aid kit

- Pull up the catch to open the storage compartment ⇒ fig. 265.

On vehicles with a load-through hatch\*, the first-aid kit is kept in the rear centre armrest. The centre armrest has to be folded down in order to access the compartment.

The storage compartment will hold a maximum weight of 0.5 kg.

#### **i** Note

Before folding the centre armrest back up into the rear seat backrest make sure the lid of the storage compartment is properly closed. ■

Applies to vehicles: with fire extinguisher

## Fire extinguisher

*The factory-fitted fire extinguisher is located in the footwell on the front passenger's side (secured in a holder).*

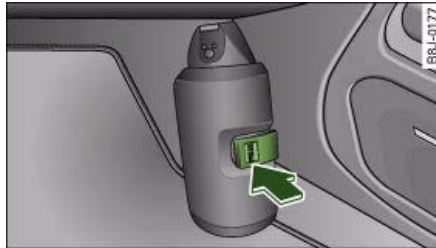

Fig. 266 Fire extinguisher in footwell on front passenger's side

### Taking out the fire extinguisher

- Unfasten the retaining strap by pressing on the tab marked "PRESS" ⇒ fig. 266 -arrow-.
- Take the fire extinguisher out of the holder.

### Securing the fire extinguisher

- Place the fire extinguisher in the holder.
- Secure the fire extinguisher with the retaining strap.

### After using the fire extinguisher

- Have the fire extinguisher refilled and checked by a qualified dealer or the fire service.

Check how the fire extinguisher works before you need to use it. The instructions for use are shown on the fire extinguisher.

Have the fire extinguisher checked regularly (at least every two years) by a qualified dealer or by the fire service to ensure that it will be in working order when you need it.

When buying a new fire extinguisher, make sure it fits in the holder.

### ! WARNING

**If the fire extinguisher is not secured properly it could be catapulted through the vehicle during driving and braking manoeuvres or in the event of an accident. This poses a risk of injury to occupants.**

### i Note

- The fire extinguisher must comply with legal requirements.
- Observe the expiry date of the fire extinguisher. The fire extinguisher may not work properly after the expiry date. ■

## Tools and Tyre Mobility System

*The tools and the Tyre Mobility System are stored under the floor panel in the luggage compartment.*

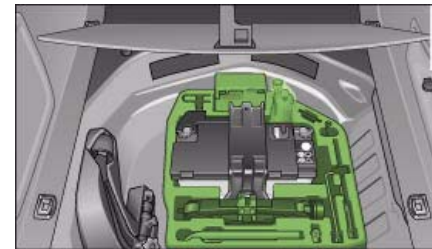

Fig. 267 Luggage compartment: Tools, Tyre Mobility System and jack

If you need the tools, the Tyre Mobility System or the jack\*, you will have to open the floor panel and take out the spare wheel\* ⇒ *page 284*.

The tool kit includes:

- A hook for removing hub caps
- Pin for mounting a wheel
- Screwdriver with reversible blade
- Tool for changing bulbs
- Interchangeable socket (Torx socket for changing bulbs)
- Crank handle for jack
- Adapter for anti-theft wheel bolts\*
- Jack\*
- Box spanner for wheel bolts
- Towline anchorage

Some of the parts listed are only fitted on certain models or are optional extras.

Before stowing the jack\* again, wind down the arm of the jack as far as it will go.

#### **WARNING**

- **Do not use the hexagonal socket in the screwdriver handle to tighten the wheel bolts. It is not possible to tighten the bolts with the required torque – risk of accident.**
- **The jack supplied by the factory is only designed for changing wheels on this model. On no account attempt to use it for lifting heavier vehicles or other loads – risk of injury.**
- **Never start the engine when the vehicle is on the jack - risk of accident.**
- **If work has to be done under the vehicle, ensure that it is safely supported on stands designed for the purpose, otherwise there is a risk of injury. ■**

Applies to vehicles: with compact temporary spare wheel

### **Compact temporary spare wheel\***

*The spare wheel is carried in the wheel well under the floor panel in the luggage compartment. It is only intended for temporary use over short distances.*

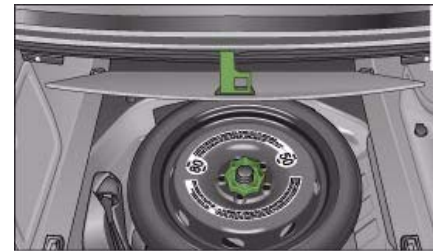

Fig. 268 Spare wheel

#### **Taking out the spare wheel**

- Lift the floor panel by the plastic handle ⇒ fig. 268.
- Hook the handle onto the luggage compartment weatherstrip.
- Turn the centre plastic knob ⇒ fig. 268 anti-clockwise.
- Take out the spare wheel.
- Unhook the floor panel before closing the boot lid.

#### **Securing the defective wheel in the spare wheel well**

- Place the wheel in the spare wheel well and secure it with the plastic knob.
- Unhook the floor panel before closing the boot lid. ►

### How to use the compact temporary spare wheel

Should you ever have a punctured tyre, the compact temporary spare wheel is only intended for temporary use until you can reach a workshop. The standard-size road wheel should be refitted as soon as possible.

Please note the following restrictions when using the compact temporary spare wheel. The compact temporary spare wheel is designed specifically for this model. For this reason, do not use a temporary spare from a different type of vehicle.

### Snow chains

For technical reasons, snow chains must **not** be used on the compact temporary spare wheel.

If you should have a puncture on one of the *front wheels* when using snow chains, fit the compact temporary spare in place of one of the rear wheels. You can then attach the snow chains to the wheel taken from the rear and use this wheel to replace the punctured front wheel.

### WARNING

- **The tyre pressures must be checked and corrected as soon as possible. The tyre pressure of the compact temporary spare wheel must be 4.2 bar – an incorrectly inflated tyre can cause an accident.**
- **Do not drive faster than 80 km/h - higher speeds can cause an accident.**
- **Avoid heavy acceleration, hard braking and fast cornering – risk of accident.**
- **Never use two or more compact spare tyres at the same time – risk of accident.**
- **No other type of tyre (normal summer or winter tyres) may be fitted on the compact temporary spare wheel. ■**

## Tyre repairs

### General information and safety notes

*Repaired tyres are only suitable for temporary use.*



Fig. 269 The Tyre Mobility System is **NOT** suitable for repairing this type of damage to tyres.

Your vehicle is equipped with a tyre repair kit: the **Tyre Mobility System (TMS)**.

In the event of a puncture you will find the **TMS**, which consists of a sealing compound and an electric compressor, located under the floor panel in the luggage compartment.

The **TMS** will reliably seal tyres damaged by foreign bodies, provided that the cuts or punctures are no larger than approx. **4 mm** in diameter.

It is not necessary to remove the foreign body from the tyre.

#### The sealing compound must not be used:

- on cuts and punctures larger than 4 mm ⇒ fig. 269 ①
- if the wheel rim has been damaged ②
- if you have been driving with very low pressure or a completely flat tyre ③.

How to use the **TMS** is described in the section **Repairing a tyre** ⇒ *page 286* and in the instructions supplied with the tyre sealant can.

The TMS can be used at outside temperatures down to – 20 °C.

### **WARNING**

After repairing a tyre please note the following points:

- Do not drive faster than 80 km/h.
- Avoid heavy acceleration, hard braking and fast cornering.
- Vehicle handling could be impaired.
- Tyres which have been sealed using the TMS are only suitable for temporary use. Damaged tyres must be renewed.
- The TMS must NOT be used,
  - on cuts and punctures larger than 4 mm
  - if the wheel rim has been damaged
  - if you have been driving with very low pressure or a completely flat tyre
- Seek professional assistance if the repair of a tyre puncture is not possible with the sealing compound.
- Do not allow the sealant to come into contact with your eyes, skin or clothing.
- If you do come into contact with the sealant immediately rinse the eyes or skin affected with clean water.
- Change clothing immediately if it becomes soiled with the tyre sealant.
- Make sure you do not breathe in the fumes!
- If any of the tyre sealant is accidentally ingested, immediately rinse the mouth thoroughly and drink lots of water.
- Do not induce vomiting. Immediately contact a doctor!
- If any allergic reactions should occur get medical help immediately.
- Keep the sealant away from children.

### **For the sake of the environment**

Used bottles of sealing compound can be returned to an Audi dealer for disposal.

### **Note**

- If sealant should leak out, leave it to dry. When it has dried, you can pull it off like a piece of foil.
- Observe the expiry date stated on the sealing compound can. Have the sealing compound exchanged by a qualified workshop. ■

### Repairing a tyre



Fig. 270 Repairing a tyre

### Preparations

- If you have a flat tyre, stop the car well away from moving traffic.
- Apply the **parking brake** to stop the vehicle moving accidentally.
- Engage **first gear** (manual gearbox) or move **selector lever to position P** (automatic gearbox). ►



- Check whether a repair is possible using the Tyre Mobility System ⇒ *page 285*.
- Ensure that all passengers **leave the vehicle** and move away from the danger area ⇒ .
- Take the **tyre sealant can** and the **electric compressor** out of the luggage compartment ⇒ *page 283*.
- Fix the sticker “max. 80 km/h”, which is included with the tyre sealant can, onto the instrument cluster where the driver will see it.

#### Filling the tyre

- Shake the tyre sealant can well.
- Screw the enclosed filling hose onto the sealant can as far as it will go. This will automatically pierce the foil sealing the can.
- Take the valve cap off the tyre valve and use the enclosed valve insert tool to unscrew the valve insert ⇒ *page 286*, fig. 270.
- Place the valve insert onto a clean surface.
- Remove the sealing plug from the filling hose and insert the hose into the tyre valve.
- Hold the tyre sealant can upside down and fill the complete contents of the can into the tyre.
- Then disconnect the hose and screw the valve insert firmly back into the tyre valve.

#### Inflating the tyre

- Screw the filling hose of the electric compressor onto the tyre valve and plug the connector into the cigarette lighter.
- Pump the tyre up to 2.0 to 2.5 bar and monitor the pressure shown on the pressure gauge.
- If the tyre pressure remains lower than the value specified above drive the vehicle approx. 10 metres forwards or backwards, so that the sealant can spread evenly in the tyre. If the pressure is still lower than the specification the tyre is too badly damaged and cannot be repaired using the tyre sealant.

#### Final checks

- After about 10 minutes stop to check the tyre pressure.
- If tyre pressure is less than 1.3 bar, the tyre is too badly damaged. Do not drive on. You should obtain professional assistance.

#### WARNING

- If you have a puncture in moving traffic, switch on the hazard warning lights and place the warning triangle in a visible location. This is for your own safety and also warns other road users.
- Make sure your passengers wait in a safe place (for instance behind the roadside crash barrier).
- Please observe the manufacturers' safety notes on the compressor and the instructions supplied with the tyre sealant can.
- If it was not possible to build up a tyre pressure of 2.0 bar within 6 minutes this means that the tyre is too badly damaged. Do not drive on.

**⚠ WARNING (continued)**

- **Seek professional assistance if the repair of a tyre puncture is not possible with the sealing compound.**
- **If tyre pressure is less than 1.3 bar after driving about 10 minutes, the tyre is too badly damaged. Do not drive on. You should obtain professional assistance.**

**⚠ Caution**

Take special care if you have to repair a tyre on a gradient.

**i Note**

- Do not use the compressor for longer than 6 minutes at a time, as it could overheat. When the compressor has cooled down, you can use it again.
- If tyre sealant should leak out, leave it to dry and then pull it off like foil.
- After carrying out a tyre repair remember to buy a new tyre sealant can at a qualified workshop. This will ensure that the Tyre Mobility System is operative again.
- Please observe the relevant regulations. ■

## Changing a wheel

### Preparations

*Some preparations are necessary before changing a wheel.*

- If you have a flat tyre, stop the car well away from moving traffic. Choose a location that is as **level** as possible.

- All passengers should **leave the car**. They should wait in a safe place (for instance behind the roadside crash barrier).
- Apply the **parking brake** to stop the vehicle moving accidentally.
- Engage **first gear** (manual gearbox) or move **selector lever to position P** (automatic gearbox).
- When towing a trailer: unhitch the trailer from your vehicle.
- Take the **tools** ⇒ *page 283* and the **spare wheel\*** ⇒ *page 284* out of the luggage compartment.

**⚠ WARNING**

**If you have a puncture in moving traffic, switch on the hazard warning lights and place the warning triangle in a visible location. This is for your own safety and also warns other road users.**

**⚠ Caution**

If you have to change the tyre on a gradient, block the wheel opposite the wheel being changed by placing a stone or similar object under it to prevent the vehicle from rolling away.

**i Note**

Please observe the relevant regulations. ■

### How to change a wheel

*Change the wheel as described below.*

- Pull off the **hub cap**. Also refer to ⇒ *page 289*, "Hub caps".

- Loosen the **wheel bolts** ⇒ *page 289*.
- **Raise** the car with the jack\* ⇒ *page 290*.
- **Take off** the wheel with the flat tyre and then **put on** the spare wheel\* ⇒ *page 291*.
- **Lower** the vehicle to the ground.
- Tighten the wheel bolts **firmly** in diagonal sequence with the box spanner ⇒ *page 289*.
- Fit the **hub cap** back on. ■

### After changing a wheel

*What you must do after changing a wheel.*

- Place the wheel with the defective tyre **in the spare wheel well** and secure it.
- Put the tools and the jack\* back in the luggage compartment.
- The **inflation pressure** of the newly fitted spare tyre must be checked as soon as possible.
- Have the **tightening torque** of the wheel bolts checked as soon as possible with a torque wrench. The correct tightening torque is 120 Nm.
- Have the flat tyre **replaced** as quickly as possible.

#### Note

- If you notice that the wheel bolts are corroded and difficult to turn when changing a wheel, they must be replaced before having the tightening torque checked.
- In the interest of safety, drive at moderate speeds until the tightening torque of the wheel bolts has been checked. ■

### Hub caps

*The hub caps must be removed for access to the wheel bolts.*

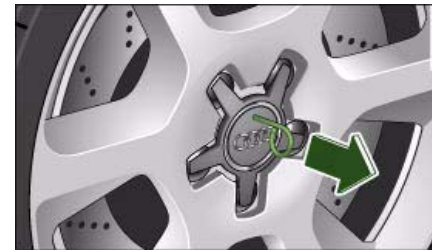

Fig. 271 Changing a wheel: Removing a hub cap

### Removing

- Insert the **hook** (provided in the vehicle's tool kit) in the hole in the hub cap.
- Pull off the **hub cap** ⇒ fig. 271. ■

### Loosening and tightening the wheel bolts

*The wheel bolts must be loosened before raising the vehicle.*



Fig. 272 Changing a wheel: Loosening wheel bolts

**Loosening**

- Fit the **box spanner** as far as it will go over the wheel bolt<sup>5)</sup>.
- Grip the box spanner as close to the *end* as possible and turn the wheel bolts about *one* turn **anti-clockwise** ⇒ *page 289*, *fig. 272* -arrow-.

**Tightening**

- Fit the box spanner as far as it will go over the wheel bolt<sup>5)</sup>.
- Grip the box spanner as close to the *end* as possible and tighten the bolt firmly by turning **clockwise**.

**WARNING**

To avoid accidents, the wheel bolts should only be loosened slightly (about one turn) before raising the vehicle with the jack\*.

**Note**

- Do not use the hexagonal socket in the screwdriver handle to loosen or tighten the wheel bolts.
- If the wheel bolt is very tight, it may be possible to loosen it by pushing down the end of the spanner carefully with your *foot*. Hold on to the car for support and take care not to slip. ■

<sup>5)</sup> An adapter is required to unscrew or tighten the anti-theft wheel bolts\* ⇒ *page 292*.

**Raising the vehicle**

The vehicle must be raised with the jack\* to remove the wheel.

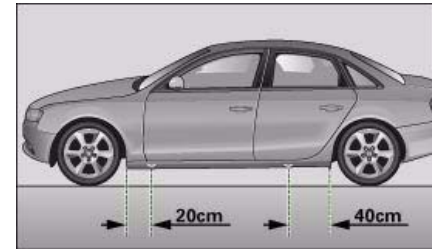

Fig. 273 Changing a wheel: Jacking points

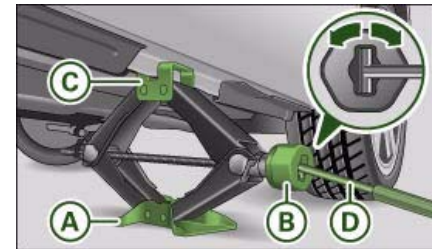

Fig. 274 Changing a wheel: Jack

Each jacking point is marked by a recess underneath the vehicle ⇒ *fig. 273*.

- Place the jack ⇒ *page 283* underneath the **jacking point** closest to the wheel being changed. Make sure the base plate **(A)** is flat on the ground.
- Wind up the jack by the knob **(B)** until the claw of the jack **(C)** completely surrounds the **seam** on your vehicle ⇒ *fig. 274*. ▶

- Now fit the crank handle **D** onto the jack by inserting it in the opening on the knob ⇒ *page 290*, fig. 274. Turn the crank handle clockwise or anti-clockwise to secure it in place.
- Raise the vehicle by winding the crank handle until the defective wheel is clear of the ground.

Recesses at the front and rear of the door sills mark the jacking points ⇒ *page 290*, fig. 273. There is *one* jacking point for each wheel. The distance from the jacking points to the wheel arches is approximately 20 cm at the front and 40 cm at the rear. The jack may **only** be applied at the seam of the jacking points shown.

An **unstable surface** under the jack may cause the vehicle to slip off the jack. Always provide a firm base for the jack on the ground. If necessary use a large, strong board or similar support. On a **hard, slippery surface** (such as tiles) use a rubber mat or similar to prevent the jack from slipping.

**! WARNING**

- Prevent the base of the jack from slipping – risk of injury.
- The car can be damaged if the jack is not applied at the correct jacking points. There is also a risk of injury since the jack can slip off suddenly if it is not properly engaged. ■

### Taking off the wheel and putting on the spare wheel

*Step-by-step instructions for taking off the wheel and putting on the spare wheel.*



Fig. 275 Changing a wheel: Hexagonal socket in screwdriver handle to turn the wheel bolts after they have been loosened



Fig. 276 Changing a wheel: Mounting pin in wheel bolt hole nearest to the top

Change the wheel as described below after loosening the wheel bolts and raising the vehicle with the jack\*.

#### Taking off the wheel

- Using the **hexagonal socket** in the screwdriver handle (provided in the vehicle's tool kit) ⇒ fig. 275, unscrew the wheel bolt nearest to the *top* and place the bolt on a clean surface. ▶

- Screw in the **mounting pin** (provided in the vehicle's tool kit) by hand in place of the wheel bolt ⇒ *page 291*, fig. 276.
- Then unscrew the other wheel bolts as described above.
- Take off the wheel. The mounting pin stays where it is.

#### Putting on the spare wheel

- Put on the spare wheel, using the mounting pin to guide it into place.
- Screw in the wheel bolts and tighten them *lightly* using the hexagonal opening in the screwdriver handle.
- Then unscrew the mounting pin and tighten the remaining wheel bolt lightly.
- Carry out the steps required after you have changed the wheel ⇒ *page 289*, "After changing a wheel".

The wheel bolts should be clean and turn easily. Before putting on the spare wheel, inspect the condition of the wheel and hub mounting surfaces. These surfaces must be clean before mounting the wheel.

The wheel bolts are easier to remove from the wheel rim if you use the hexagonal socket in the screwdriver handle. The reversible screwdriver blade should be removed as a precautionary measure when the tool is used for this purpose.

Note the direction of rotation when putting on a tyre with **directional tread pattern** ⇒ *page 292*.

#### Note

Do not use the hexagonal socket in the screwdriver handle to loosen or tighten the wheel bolts. ■

#### Tyres with directional tread pattern

*Tyres with directional tread pattern must be mounted so that they rotate in the correct direction.*

A directional tread pattern is identified by **arrows on the sidewall** pointing in the forward running direction. Always note the direction of rotation indicated when mounting the wheel. This is important so that these tyres can give maximum grip and avoid excessive noise, tread wear and aquaplaning.

Drive carefully should you ever have a puncture and have to mount the spare wheel so it rotates in the wrong direction. This is because the tyre will not give optimum performance. Bear this in mind particularly when driving on wet roads.

To benefit from the advantages of tyres with this type of tread pattern, the defective tyre should be replaced and refitted as soon as possible so that all tyres again rotate in the correct direction. ■

Applies to vehicles: with anti-theft wheel bolts

#### Anti-theft wheel bolts

*A special adapter is required to turn the anti-theft wheel bolts.*

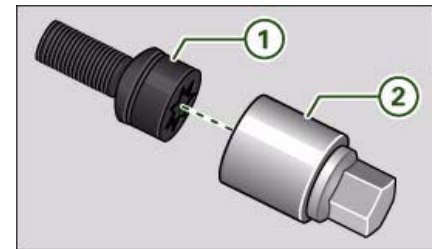

Fig. 277 Anti-theft wheel bolt with adapter

- Insert the **hook** (provided in the vehicle's tool kit) in the hole in the hub cap.
- Pull off the **hub cap** ⇒ *page 289*, fig. 271.
- Insert the adapter ② completely into the wheel bolt ①.
- Fit the box spanner as far as it will go over the adapter ②.
- Loosen or tighten the wheel bolt ⇒ *page 289*.

It is advisable to carry the wheel bolt adapter in the vehicle. The adapter is normally stored in the vehicle tool kit, underneath the towline anchorage. It should be put back there after use.

The **code number** of the anti-theft wheel bolt is stamped on the front of the adapter. Your Audi dealer will need this number to replace the adapter if lost.

#### Note

Note the code number of the anti-theft wheel bolt and keep it in a safe place – not in your vehicle. ■

## Jump-starting

### Before starting the engine

*If necessary, the engine can be started by connecting it to the battery of another vehicle.*

If the engine should ever fail to start because of a discharged battery, the battery can be connected to the battery of *another* vehicle to start the engine. Suitable **jump leads** are required.

Both batteries must be rated at 12 Volts. The **capacity** (Ah) of the booster battery should not be significantly lower than that of the discharged battery.

#### Jump leads

The jump leads must be **heavy enough** to carry the starter current. Refer to the details given by the manufacturer.

Only use jump leads with *insulated* battery clamps.

**Positive cable** – usually red

**Negative cable** – usually black

#### WARNING

- When it is discharged the battery can freeze at temperatures around 0°C. A frozen battery must first be thawed out before connecting the jump leads, as it could otherwise explode.
- Please note the safety warnings referring to working in the engine compartment ⇒ *page 255*.

#### Note

- There must be no contact between the two vehicles as otherwise current could flow as soon as the positive terminals are connected.
- The discharged battery must be properly connected to the vehicle's electrical system.
- Switch off the car telephone if necessary. Details will be given in the manufacturer's instructions for the car telephone. ■

## Starting the engine

The two jump leads must be connected in the correct sequence.

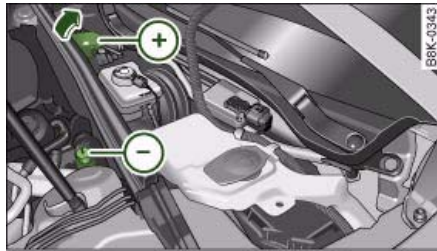

Fig. 278 Engine compartment: Terminals for jump leads and battery charger

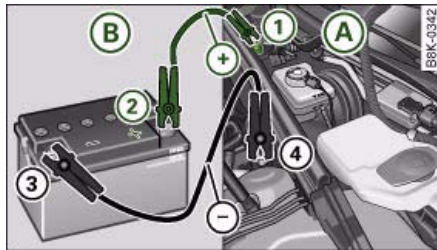

Fig. 279 Jump-starting with the battery of another vehicle: A – Discharged battery, B – Boosting battery

The jump-start terminals are located in the engine compartment ⇒ fig. 278.

### Connecting the positive terminals with the positive lead (red)

- Open the red cap on the positive terminal ⇒ fig. 278.
- 1. Connect one end of the lead to the **jump-start terminal** ⇒ fig. 279 (1) (terminal under red cap = “positive”) of the vehicle with the flat battery (A).

- 2. Connect the other end of the positive lead to the positive terminal (2) of the boosting battery (B).

### Connecting negative terminals with the negative lead (black)

- 3. Connect one end of the negative lead to the negative terminal (3) of the boosting battery (B).
- 4. Connect the other end of the lead to the **jump-start terminal** (4) (terminal with hexagon = “negative”) of the vehicle with the flat battery (A).

### Starting the engine

- Start the engine of the vehicle with the boosting battery (B) and let it run at idling speed.
- Now start the engine of the vehicle with the discharged battery (A).
- If the engine fails to start: do not operate the starter for longer than 10 seconds. Wait for about 30 seconds and try again.
- When the engine is running, disconnect the leads in exactly the *opposite* sequence to that described above.
- Refit the red cap onto the positive terminal.

The battery is vented to the outside to prevent gases entering the vehicle's interior.

Connect the battery clamps so they have good *metal-to-metal* contact with the respective terminals.

### WARNING

- The non-insulated parts of the battery clamps must not be allowed to touch. The jump lead attached to the positive battery ►



**⚠ WARNING (continued)**

**terminal must not touch metal parts of the vehicle: this can cause short circuiting.**

- Do not bend over the batteries – risk of acid burns.
- The screw plugs on the battery cells must be screwed in firmly.
- Keep sparks, flame and lighted cigarettes away from batteries: the gases given off can cause an explosion.
- If jump-starting another vehicle, position the jump leads in such a way that they cannot come into contact with any moving parts in the engine compartment of the other vehicle.

**! Caution**

Please note that the above method of connecting the leads is meant for jump-starting your vehicle. If jump-starting another vehicle, you should not connect the negative lead (–) to the negative terminal of the discharged battery, but directly to the engine block or a solid metal part bolted to the engine block. If the battery of the other vehicle does not have a gas vent, there is a risk that a mixture of oxygen and hydrogen gas can accumulate and cause an explosion. ■

## Tow-starting and towing away

### General notes

*Points to observe when tow-starting or towing away*

If you use a towrope:

**Notes for the driver of the towing vehicle**

- The towrope must be taut before driving off.

- Engage the clutch very gently when starting to move; on vehicles with automatic gearbox press the accelerator slowly.

**Notes for the driver of the towed vehicle**

- The ignition should be switched on so that the turn signals, horn, windscreen wipers and washers can be used. Please ensure that the steering wheel is unlocked when you switch on the ignition, and that it moves freely.
- Put gear lever **in neutral** (manual gearbox) or move **selector lever to position N** (automatic gearbox).
- The brake servo and power steering only work when the engine is running. Considerably more effort is required on the brake pedal and steering wheel when the engine is switched off.
- Ensure that the towrope remains taut at all times when towing.

**Towrope or towbar**

It is easier and safer to tow a vehicle with a towbar. You should only use a towrope if you do not have a towbar.

A towrope should be slightly elastic to reduce the loading on both vehicles. It is advisable to use a **towrope made of synthetic fibre** or similar material.

Attach the tow-rope or tow-bar only to the **towing anchorages** intended for this purpose ⇒ *page 296* or ⇒ *page 297*.

**Driving technique**

Towing requires some experience – especially when using a towrope. Both drivers should be familiar with the technique required for towing. Inexperienced drivers should not attempt to tow-start or tow away another vehicle. ▶

Do not pull too hard with the towing vehicle and take care to avoid jerking the towrope. When towing on a loose surface there is always a risk of overloading and damaging the anchorage points.

### ⚠ Caution

If there is no oil in the gearbox or no lubricant in the automatic transmission the car may only be towed with the driven wheels lifted clear of the road, or transported on a special car transporter or trailer.

### ℹ Note

- Note the regulations concerning towing.
- The hazard warning lights of both vehicles must normally be switched on. However, observe any regulations to the contrary.
- Make sure that the towrope is not twisted, as otherwise the front towline anchorage on your vehicle could work itself loose. ■

### Front towline anchorage

*The front towline anchorage is only mounted if the vehicle has to be towed.*



Fig. 280 Front bumper: Cover cap



Fig. 281 Front bumper: Fitting the towing eye

The screw connection for the towline anchorage is located behind a cover cap on the right side of the front bumper.

- Take the towline anchorage out of the vehicle's tool kit ⇒ *page 283*.
- To detach the cover cap from the bumper, firmly press the lower part of the cap inwards to release it ⇒ *fig. 280*.
- Screw the towline anchorage firmly all the way into the screw connection ⇒ *fig. 281*.

After use, unscrew the towline anchorage and put it back in the toolbox. Replace the cap in the bumper. The towline anchorage should always be kept in the vehicle.

### ⚠ WARNING

**If the towline anchorage is not screwed in as far as the stop, there is a risk of the screw connection shearing off during towing (accident risk). ■**

### Rear towline anchorage

Vehicles which do not have a factory-fitted towing bracket\* have a towline anchorage on the right side of the rear bumper.

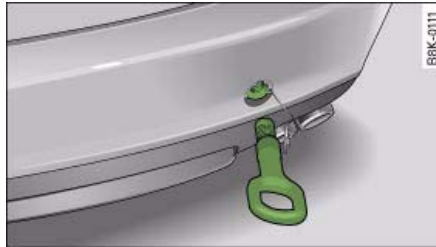

Fig. 282 Rear bumper:  
Fitting the towing eye

#### Vehicles with towline anchorage

- Take the towline anchorage out of the vehicle's tool kit.
- To detach the cover cap from the bumper, firmly press the lower part of the cap inwards to release it ⇒ fig. 282.
- Screw the towline anchorage firmly all the way into the screw connection.

#### Vehicles with towing bracket\*

- Fit the towing bracket.
- Attach the towbar or the towrope to the towing bracket.

After use, unscrew the towline anchorage and put it back in the toolbox. Replace the cap in the screw connection. The towline anchorage or towing bracket should always be kept in the vehicle.

Vehicles which have a factory-fitted towing bracket\* do **not** have a screw connection at the rear for the towline anchorage.

### WARNING

- If the towline anchorage is not screwed in as far as the stop, there is a risk of the screw connection shearing off during towing (accident risk).
- If your car has a towing bracket\*, please use only special tow bars with suitable attachments (i.e. tow bars which are specially designed for use with towing brackets) to avoid damage to the coupling equipment.
- If your car has a towing bracket\*, please use only special towing ropes (risk of accident). ■

### Tow-starting

As a general rule, tow-starting is not recommended.

- Engage 2nd or 3rd gear before moving off.
- Press the clutch and hold the pedal down.
- Switch on the ignition.
- Once both vehicles are moving, release the clutch.
- As soon as the engine starts: press the clutch and put the gear lever in neutral.

If the engine will not start, it is best to try starting it using the battery of another vehicle ⇒ *page 293* before attempting to tow start. You should only try to tow-start the engine if jump-starting is not successful. Tow-starting is an attempt to start the engine via the movement of the wheels.

When tow-starting a vehicle with a **petrol engine**, do not tow it more than a *short* distance, otherwise unburnt fuel can enter the catalytic converter and cause damage.

For technical reasons, it is not possible to **tow-start** a vehicle with **automatic gearbox**.

**! WARNING**

**There is a high risk of accidents when tow-starting, as the towed vehicle can easily be driven into the towing vehicle.**

**! Caution**

When tow-starting the vehicle, do not tow it further than 50 metres: otherwise the catalytic converter could be damaged. ■

### Towing a vehicle with manual gearbox and front-wheel drive

*Towing is relatively straightforward.*

Please observe the notes ⇒ *page 295*.

The vehicle can be towed using a towbar or towrope in the normal way, with all four wheels on the road; it can also be towed with either the front or rear wheels lifted off the road. The vehicle must not be towed faster than **50 km/h**. ■

### Towing a vehicle with automatic gearbox and front-wheel drive

*Certain restrictions must be observed when towing your vehicle.*

Please observe the notes ⇒ *page 295*.

The vehicle can be towed with a towbar or towrope in the normal way, with all four wheels on the ground. When doing so, please note the following points:

- Release the parking brake ⇒ *page 121*.
- Make sure the selector lever is in the **N** position.
- The vehicle must not be towed faster than **50 km/h**.

- The vehicle must not be towed further than **50 km**. The reason for this is: when the engine is not running, the gearbox oil pump does not work and the gearbox is not adequately lubricated for higher speeds or longer distances.

If the vehicle has to be towed with a **breakdown truck**, it must only be suspended at the *front* wheels. The reason for this is: the drive shafts are located on the front wheels. If the car is towed with the rear wheels lifted off the road (i.e. travelling backwards), the drive shafts also turn *backwards*. The planetary gears in the automatic gearbox then turn at such high speeds that the gearbox will be severely damaged in a short time.

**i Note**

If it is not possible to tow the vehicle as described above, or if it has to be towed further than 50 km, it must be transported on a special car transporter or trailer. ■

### Towing a vehicle with manual gearbox and four-wheel drive

*Certain restrictions must be observed when towing your vehicle.*

Please observe the notes ⇒ *page 295*.

The vehicle can be towed with a towbar or towrope in the normal way, with all four wheels on the ground. It can also be towed by a breakdown truck, with the wheels lifted at either the front or rear. When doing so, please note the following points:

- The vehicle must not be towed faster than **50 km/h**.
- The vehicle must not be towed further than **50 km**. ▶

 **Note**

If it is not possible to tow the vehicle as described above, or if it has to be towed further than 50 km, it must be transported on a special car transporter or trailer. ■

### Towing a vehicle with automatic gearbox and four-wheel drive

*Certain restrictions must be observed when towing your vehicle.*

Please observe the notes ⇒ *page 295*.

The vehicle can be towed with a towbar or towrope in the normal way, with all four wheels on the ground. When doing so, please note the following points:

- Release the parking brake ⇒ *page 121*.
- Make sure the selector lever is in the **N** position.
- The vehicle must not be towed faster than **50 km/h**.
- The vehicle must not be towed further than **50 km**. The reason for this is: when the engine is not running, the gearbox oil pump does not work and the gearbox is not adequately lubricated for higher speeds or longer distances.

The vehicle must not be towed with the wheels lifted at either the front or rear.

 **Note**

If it is not possible to tow the vehicle as described above, or if it has to be towed further than 50 km, it must be transported on a special car transporter or trailer. ■

## Fuses and bulbs

### Fuses

#### Changing a fuse

*If a fuse has blown it must be replaced.*

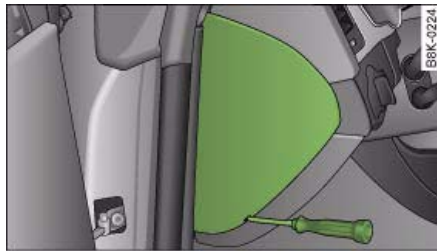

Fig. 283 Left side of dash panel: Fuse cover

- Identify the fuse for the failed component.
- Switch off the ignition and the component concerned.
- Remove the fuse box cover ⇒ fig. 283.
- Take the plastic clip from inside the fuse cover, fit it onto the blown fuse, and pull the fuse out.
- Replace the blown fuse (which will have a melted metal strip) with a new fuse of the *same* amp rating.

The various electrical circuits are protected by fuses. The fuse boxes are located behind covers on the left and right sides of the dash panel and in the compartment on the right side of the boot.

A plastic clip for removing the fuses is provided in the fuse cover on the left side of the dash panel. There is also a sticker listing the fuses in each of the fuse boxes in the dash panel.

#### ! Caution

Never attempt to "repair" a fuse or replace it by fitting a fuse with a higher rating - risk of fire! It could also cause damage to other parts of the electrical system.

#### i Note

If a newly replaced fuse blows again after a short time, the electrical system must be checked by a qualified workshop as soon as possible. ■

#### Fuses on the driver's side

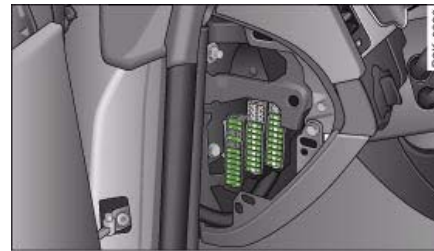

Fig. 284 Diagram of fuse box (left-hand drive vehicle)

Some of the items listed are only fitted on certain models or are optional extras.

Please note that the following list, while correct at the time of printing, is subject to alterations. If discrepancies should occur, please refer to the sticker on the inside of the fuse cover for the correct information for your vehicle. ►

The seats with electrical adjustment are protected by **circuit breakers**. These reset automatically after a few seconds when the overload has been corrected.

#### Fuse list

No.	Electrical equipment	amps
<b>Fuse carrier (black)</b>		
1	Dynamic steering	5
2	Clutch sensor	5
3	Garage door opener	5
4	Audi lane assist	10
5	Air conditioner	5
6	Headlight range control (right)	5
7	Headlight range control (left)	5
8	Control unit 1 for vehicle's electrical system	5
9	Interior mirrors	5
10	Selector gate	5
11	Heated washer jets	5
12	Air conditioner	5

#### Fuse list

No.	Electrical equipment	amps
<b>Fuse carrier (brown)</b>		
1	Vacant	
2	Clutch sensor	5
3	Fuel pump (diesel/petrol)	20/25
4	Auxiliary water pump (3.2 FSI)	5

No.	Electrical equipment	amps
5	Seat heating (left-side) with/without seat ventilation	30
6	Electronic stabilisation program	10
7	Horn	25
8	Electric window motor (left door)	30
9	Wiper motor	30
10	Electronic stabilisation program	25
11	Door control unit (driver's side)	15
12	Rain and light sensor	5

#### Fuse list

No.	Electrical equipment	amps
<b>Fuse carrier (red)</b>		
1	Vacant	
2	Vacant	
3	Lumbar support	10
4	Dynamic steering	35
5	Interior light	5
6	Control unit 1 for vehicle's electrical system	35
7	Control unit 1 for vehicle's electrical system	30
8	Control unit 1 for vehicle's electrical system	30
9	Tilting panorama roof/sun roof	20
10	Control unit 1 for vehicle's electrical system	30
11	Vacant	
12	Convenience electronics	5

**Fuses on the passenger's side**

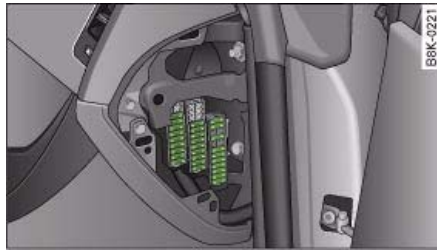

Fig. 285 Diagram of fuse box (left-hand drive vehicle)

Some of the items listed are only fitted on certain models or are optional extras.

Please note that the following list, while correct at the time of printing, is subject to alterations. If discrepancies should occur, please refer to the sticker on the inside of the fuse cover for the correct information for your vehicle.

The seats with electrical adjustment are protected by **circuit breakers**. These reset automatically after a few seconds when the overload has been corrected.

**Fuse list**

No.	Electrical equipment	amps
<b>Fuse carrier (black)</b>		
1	Vacant	
2	Vacant	
3	Vacant	
4	Vacant	
5	Steering column switch module	5
6	Electronic Stabilisation Program	5

No.	Electrical equipment	amps
7	Diagnostic connector	5
8	Gateway (diagnostic interface for data bus)	5
9	Vacant	
10	Vacant	
11	Vacant	
12	Vacant	

**Fuse list**

No.	Electrical equipment	amps
<b>Fuse carrier (brown)</b>		
1	CD drive	5
2	Switch module for Audi drive select	5
3	MMI/Radio	10/20
4	Light switch	5
5	Control unit for instrument cluster	5
6	Ignition lock	5
7	Vacant	
8	Air conditioner blower	40
9	Steering column lock	5
10	Air conditioner	10
11	Diagnostic connector	10
12	Steering column switch module	5



### Fuse list for luggage compartment

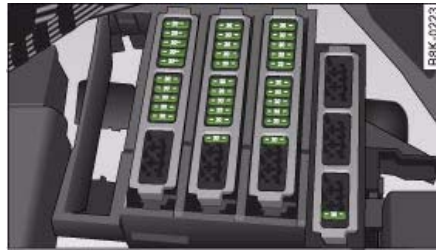

Fig. 286 Diagram of fuse panel

- Remove the trim.
- Open the fuse cover.

#### Fuse list

No.	Electrical equipment	amps
<b>Fuse carrier (black)</b>		
1	Vacant	
2	Control unit for trailer	15
3	Control unit for trailer	20
4	Control unit for trailer	20
5	Electronic parking brake	5
6	Electronic suspension control	15
7	Electro-mechanical parking brake	30
8	Control unit 2 for vehicle's electrical system	30
9	Vacant	

No.	Electrical equipment	amps
10	Control unit 2 for vehicle's electrical system	30
11	Control unit 2 for vehicle's electrical system	20
12	Vacant	

#### Fuse list

No.	Electrical equipment	amps
<b>Fuse carrier (brown)</b>		
1	Electrical socket	15
2	Vacant	
3	Radio/navigation	7.5
4	Control unit for digital sound system	30
5	MMI	5
6	Door control unit (driver's side)	30
7	Electro-mechanical parking brake	30
8	Seat heating, rear	30
9	Door control unit (passenger side)	30
10	Remote control receiver for auxiliary heating	5
11	Door control unit (passenger side)	15
12	Control unit for reversing camera	5

#### Fuse list

No.	Electrical equipment	amps
<b>Fuse carrier (red)</b>		
1	Socket, centre console, rear	15
2	Socket, centre console, front	15
3	Socket, luggage compartment	15

No.	Electrical equipment	amps
4	Cigarette lighter	15
5	Parking aid	5
6	Phone pre-installation without handsfree system (VDA interface)	5
7	Control unit for adaptive cruise control	15
8	Vacant	
9	EPB switch (electro-mechanical parking brake)	5
10	Lane change assist feature	5
11	Seat heating, rear	5
12	Airbag	5

- Xenon headlights\*: Bulb for turn signals
- Xenon headlights\*: Light source for daytime running lights/parking lights
- Bulb for headlights: **Bi-xenon** lights ⇒ ⚠
- Light source for turn signal in exterior mirror housing
- Light source for high-level brake light

As a rule, you require a certain degree of practical skill to change defective bulbs. This applies in particular to those bulbs which are only accessible from the engine compartment.

If in doubt, we recommend that you have defective bulbs changed by a qualified workshop or qualified mechanic.

If you do decide to change bulbs in the engine compartment yourself, be aware of the safety risks involved ⇒ page 255 ⇒ ⚠.

#### Types of bulbs

You must only replace a bulb with a bulb of the same type. Information regarding e.g. the wattage can be found on the base of the bulb.

Front bulb (12 V)	Version
Dipped-beam headlights (halogen)	55 W (H7)
Main beam headlights (halogen)	55 W (H7)
Front fog lights	55 W (H7)

Rear bulb (12 V)	Version
Brake lights / tail lights	P 21 W
Turn signals (rear)	P 21 W
Reversing lights	W 16 W
Rear fog light	H 21 W
Number plate lights	5 W ▶

## Bulbs

### Changing bulbs

*Changing bulbs requires a certain degree of practical skill.*

You can change the following bulbs for exterior lights **yourself**:

- Halogen headlights: Bulb for dipped headlights
- Halogen headlights: Bulb for main beam headlights
- Bulb for fog light
- Bulbs for rear lights in boot lid
- Bulbs for rear lights in side panel
- Bulbs for number plate light

The following bulbs should only be changed by a **qualified workshop**:

- Halogen headlights: Bulb for turn signals
- Halogen headlights: Bulb for side lights

 **WARNING**

- **Take particular care when working on components in the engine compartment if the engine is warm - risk of burns!**
- **Bulbs are sensitive to pressure. The glass can break when you touch the bulb, causing injury.**
- **Incorrect handling of the high-voltage element of xenon gas-discharge bulbs\* can have potentially fatal consequences.**
- **When changing bulbs, please take care not to injure yourself on sharp edges, in particular on the headlight housing.**

 **Caution**

- Always remove the ignition key before carrying out any work on the electrical system - danger of short circuiting!
- Switch off the lights or parking lights before you change a bulb.
- Take good care to avoid damaging any components.
- Removing the lights in particular can lead to the paintwork becoming damaged. This is another reason why we recommend having the bulbs changed by a qualified workshop.

 **For the sake of the environment**

Please ask your specialist retailer how to dispose of used bulbs in the proper manner.

 **Note**

Place the parts you have removed on a soft cloth so that they do not become scratched.

- Please check at regular intervals that all lighting (especially the exterior lighting) on your vehicle is functioning properly. This is not only in the interest of your own safety, but also in that of all other road users.

- Before changing a bulb, make sure you have the correct new bulb.
- Do not touch the glass part of the bulb with your bare hands, use a cloth or paper towel instead. Otherwise, the fingerprints left on the glass will vaporise as a result of the heat generated by the bulb, be deposited on the reflector and impair its surface. ■

### Bulbs with a bayonet fastener

Bulbs with a bayonet fastener must be changed as follows:

#### Removing the bulb

- Lightly press the defective bulb into the bulb holder, then turn it anti-clockwise and remove it.
- Do not touch the glass part of the new bulb with your bare hands, use a cloth or paper towel instead.

#### Fitting the bulb

- Fit the new bulb, pressing it into the bulb holder, and turn it clockwise as far as it will go.
- If necessary, use a cloth to remove any fingerprints from the glass part of the bulb. ■

### Bulb holders with a bayonet fastener



Fig. 287 Diagram: Bulb holder with a bayonet fastener

In the case of bulb holders with a bayonet fastener please proceed as follows:

#### Removing the bulb holder

- Turn the bulb holder in the direction of the arrow (A) ⇒ fig. 287 as far as it will go and then take the bulb holder out of the light unit.

#### Fitting the bulb holder

- Insert the bulb holder into the light unit, making sure you keep the bulb holder straight, i.e. the rubber seal makes even contact all around.
- Turn the bulb holder in the direction indicated by the arrow (B) ⇒ fig. 287 as far as it will go. ■

### Changing bulbs for headlights

#### Removing and installing headlights



Fig. 288 Trim panel: Attachment points are marked by arrows

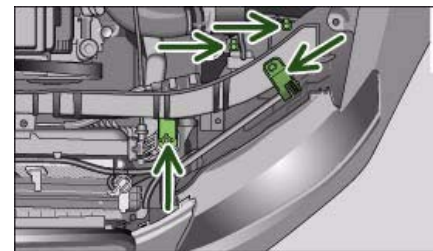

Fig. 289 Headlight unit: Attachment points are marked by arrows

The description for removing the headlight refers to the left headlight; in principle the same procedure applies to the right headlight.

#### Removing

- Switch off the ignition and the lights.
- Open the bonnet.

- Take the screwdriver and the interchangeable Torx socket out of the vehicle tool kit.
- Remove the screws ⇒ *page 306*, fig. 288 that secure the trim panel to the lock carrier and detach the trim panel.
- Slacken the two screws that secure the headlight to the lock carrier and the two screws at the underside of the headlight (the screws at the underside should not be slackened more than five turns) ⇒ *page 306*, fig. 289.
- Carefully pull the headlight forward about 60 mm.
- Release and unplug the electrical connector.
- Carefully take the headlight out towards the front (swivel it slightly if necessary).

### Installing

- Perform all of the above steps in reverse sequence.

The headlight must be inserted in two guides (on the underside of the headlight). This is the only way to ensure that the headlight is installed in the correct position. To determine whether the headlight is correctly installed, check that it is aligned flush with adjacent body parts (such as the wing panel).

Do not interchange the securing screws.

### ! Caution

Please take particular care not to damage or scratch the adjacent parts of the body when removing or installing the headlights. ■

### Removing bulb for main beam headlights

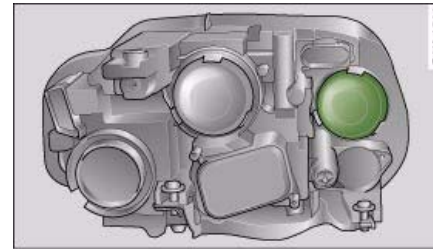

Fig. 290 Headlight unit: Rubber cap is highlighted

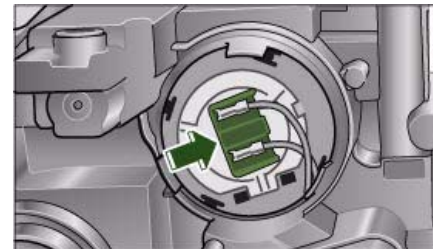

Fig. 291 Bulb holder for main beam headlights

- Remove the headlight ⇒ *page 306*.
- Take off the rubber cap ⇒ fig. 290 ⇒ ⚠ in “Changing bulbs” on *page 304*.
- Press the connector in the direction of the arrow ⇒ fig. 291.
- Remove the connector together with the bulb from the headlight housing.
- Disconnect the connector from the base of the bulb ⇒ ⚠ in “Changing bulbs” on *page 304*. ■

### Installing the bulb for the main beam headlights

When installing a bulb, the lug on the base of the bulb must be inserted into the appropriate mounting on the bulb housing.

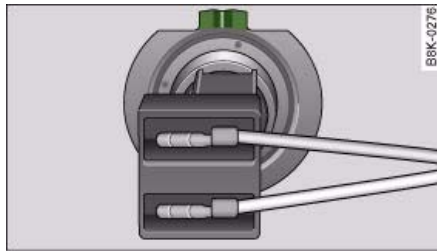

Fig. 292 Bulb with connector: The lug on the base of the bulb is highlighted

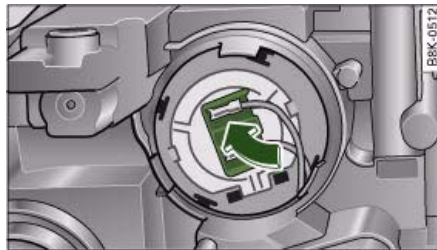

Fig. 293 Fitting bulb for main beam headlights

- Attach the new bulb to the connector ⇒ ⚠ in "Changing bulbs" on page 304.
- Insert the bulb carefully into the bulb housing. Start by placing the base of the bulb directly behind one of the retaining hooks so that the lug fits into the recess on the bulb housing.

- Press the connector in the direction of the arrow ⇒ fig. 293 until the bulb engages.
- Check that the bulb is securely seated in the bulb housing.
- Fit the rubber cap and install the headlight ⇒ page 306.
- Check whether the new bulb is working.
- Have the headlight settings checked.

#### **i** Note

Ensure that the rubber cap is seated correctly so that no water can enter the unit. ■

### Removing bulb for dipped headlights

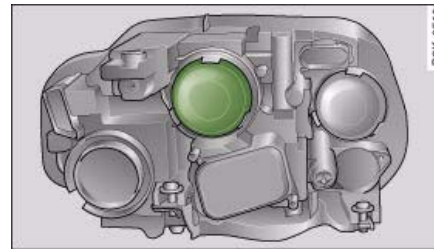

Fig. 294 Headlight unit: Cover

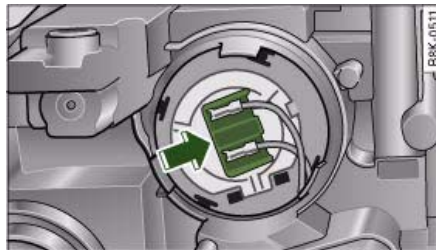

Fig. 295 Bulb holder for dipped headlights

- Remove the headlight ⇒ *page 306*.
- Take off the cover ⇒ *page 308*, fig. 294 ⇒ ⚠ in "Changing bulbs" on *page 304*.
- Press the connector in the direction of the arrow ⇒ fig. 295.
- Remove the connector together with the bulb from the headlight housing.
- Disconnect the connector from the base of the bulb ⇒ ⚠ in "Changing bulbs" on *page 304*. ■

### Installing bulb for dipped headlights

When installing a bulb, the lug on the base of the bulb must be inserted into the appropriate mounting on the bulb housing.

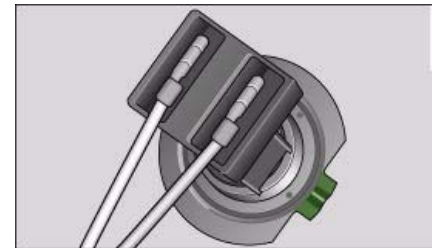

Fig. 296 Bulb with connector: The lug on the base of the bulb is highlighted

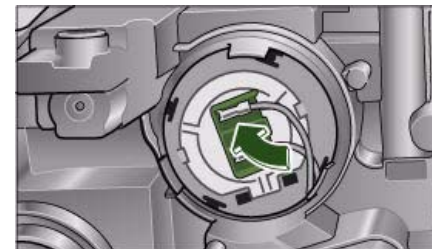

Fig. 297 Inserting bulb for dipped headlights

- Attach the new bulb to the connector ⇒ ⚠ in "Changing bulbs" on *page 304*.
- Insert the bulb carefully into the bulb housing. Start by placing the base of the bulb directly behind one of the retaining hooks so that the lug fits into the recess on the bulb housing. ▶

- Press the connector in the direction of the arrow ⇒ *page 309*, fig. 297 until the bulb engages.
- Check that the bulb is securely seated in the bulb housing.
- Fit the cover.
- Install the headlight ⇒ *page 306*.
- Check whether the new bulb is working.
- Have the headlight settings checked. ■

## Changing bulb for front fog lights

Applies to vehicles: with halogen main beam headlights

### Preparations



Fig. 298 Trim cover for fog light



Fig. 299 Screws securing fog light

The description for changing the bulb refers to the right fog light; in principle the same procedure applies to the left fog light.

- Switch off the ignition and the lights.
- Detach the trim cover ⇒ fig. 298 (pull it carefully in the direction of the arrow).
- Remove the two securing screws ⇒ fig. 299 and pull the fog light unit out of the bumper.
- Unplug the electrical connector.

### ! Caution

The trim cover is secured to the bumper by several retaining hooks. Do not use force when removing the trim cover to avoid damaging it. ■



Applies to vehicles: with halogen main beam headlights

### Changing bulb

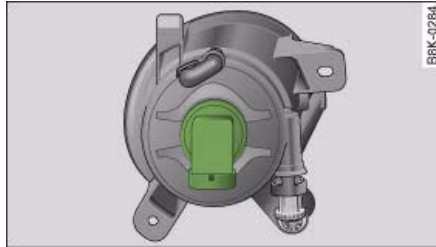

Fig. 300 Front fog light: Bulb holder is highlighted

- Turn the bulb holder anti-clockwise ⇒ *page 306* and take it out of the fog light housing.
- Insert the new bulb holder and turn it clockwise as far as the stop ⇒ *page 306*.

After changing the bulb re-install all parts in the reverse sequence and check that the bulb is working. ■

### Changing bulbs for rear lights in side panel

#### Overview of rear lights



Fig. 301 Rear lights in side panel

- Brake lights
- Turn signals

The following instructions for changing the bulb refer to the left side of the vehicle. Follow the same procedure for changing the bulb on the other side of the vehicle. ■

Applies to vehicles: with halogen main beam headlights

### Removing rear light

*To change the bulbs, you must remove the rear light. Removing the light requires a certain degree of practical skill.*

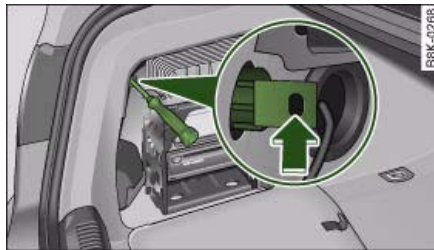

Fig. 302 Luggage compartment: Location of retaining screw for rear light

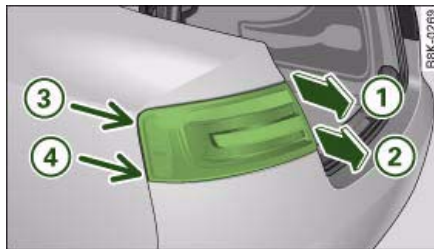

Fig. 303 Removing rear light from side panel

- Check which of the bulbs is defective.
- Open the boot lid.
- Remove the side trim.
- Insert the screwdriver (from the tool kit) through the side opening in the plastic screw ⇒ fig. 302.

- Turn the screwdriver anti-clockwise to loosen the screw and then carefully remove the screw.
- Gradually ease the light housing out of the rubber mountings (positions ⇒ fig. 303 ③ and ④) by pulling alternately in direction of arrows ① and ②. If necessary use the tool for changing bulbs from your vehicle's toolkit to carefully apply some pressure between positions ③ and ④ ⇒ ①.
- Unplug the electrical connector.
- Change the defective bulb ⇒ page 313.

#### ! Caution

When removing or installing the rear light, take care not to cause any damage.

- Removing the rear light in particular can lead to the paintwork or rear light becoming damaged. This is another reason why we recommend having the bulbs changed by a qualified workshop.
- NEVER use metal tools (e.g. a screwdriver) or sharp or pointed plastic tools to lever out the rear light - risk of damaging the paint.

#### i Note

Make sure you have a soft cloth ready to place under the glass on the rear light, to avoid any scratches. ■

## Changing bulbs

All bulbs can be changed easily after removing the rear light.

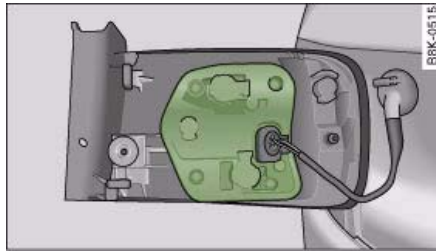

Fig. 304 Rear light, mounting plate is highlighted

- Detach the bulb carrier.
- Renew the defective bulb (pull to remove from plug-in holder or turn to remove from bayonet holder) ⇒ page 305.
- Attach the bulb carrier.
- Re-install the rear light ⇒ page 313. ■

Applies to vehicles: with halogen main beam headlights

## Installing rear light

The rear light is easy to re-install.

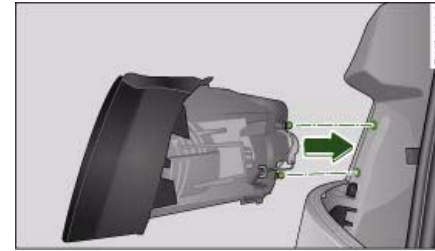

Fig. 305 Installing rear light

To re-install the rear light, follow the steps for removal in reverse sequence.

- Plug in the electrical connector. Make sure you hear it click into place.
- Insert the rear light into the rear light carrier ⇒ fig. 305.
- Press the rear light into the two rubber mountings as far as it will go. The rear light must be flush with the body contour.
- Use the screw to secure the rear light from the luggage compartment.
- Make sure that all bulbs for the rear lights are working.

### ⚠ Caution

Take care when installing the rear light to make sure there is no damage to the paintwork or any of its components. ■

## Changing bulbs in boot lid

### Rear lights in boot lid



Fig. 306 Rear lights in boot lid

- Rear fog light
- Reversing light

Before you begin working, please make yourself familiar with the different bulb versions ⇒ *page 304*. ■

### Removing bulb carrier

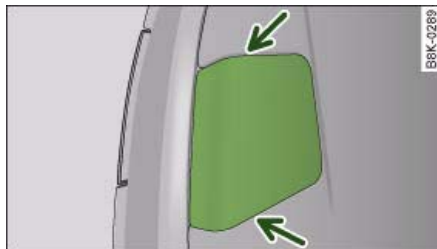

Fig. 307 Boot lid: Opening the cover in the boot lid

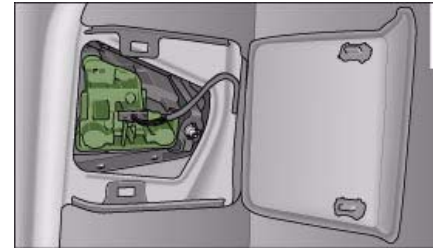

Fig. 308 Boot lid: Removing bulb carrier

The description for changing the bulb refers to the left rear light unit; in principle the same procedure applies to the right rear light unit.

- Check which of the bulbs is defective.
- Open the boot lid.
- Take the screwdriver out of the vehicle tool kit.
- Using the flat-blade side of the reversible screwdriver insert, carefully detach the cover cap ⇒ *fig. 307* -arrows-.
- Release the retaining tab and remove the bulb carrier from the light unit.
- Change the bulb ⇒ *page 315*. ■

### Changing bulb / installing bulb carrier

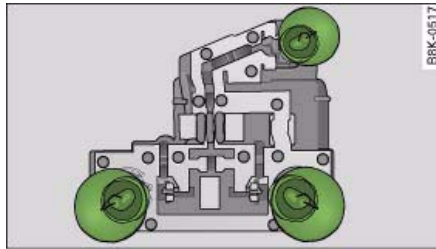

Fig. 309 Bulb carrier

- Renew the defective bulb (pull to remove from plug-in holder or turn to remove from bayonet holder) ⇒ *page 305*.
- Insert the bulb carrier into the rear light. Make sure you hear the retaining tab click into place.
- Fit the cover back in the interior trim so that it engages.
- Put the screwdriver back into the tool kit.
- Make sure that all bulbs for the rear lights are working. ■

Applies to vehicles: with halogen main beam headlights

### Number plate light

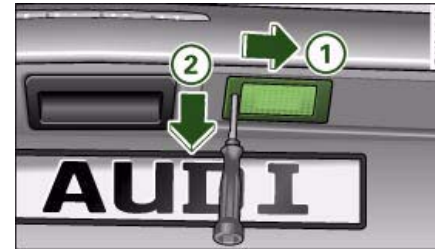

Fig. 310 Boot lid: Removing number plate light

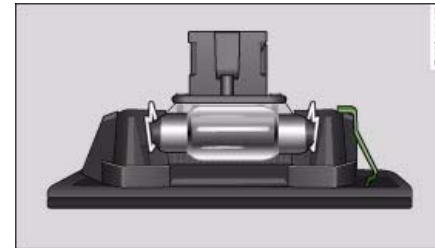
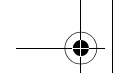

Fig. 311 Number plate light: Retaining element

### Removing number plate light

- Take the screwdriver out of the vehicle tool kit ⇒ *page 283*.
- Insert the flat-blade side of the reversible screwdriver into the slot on the number plate light ⇒ fig. 310.
- Using the screwdriver, start by pressing the number plate light to the right -arrow 1- and then pull the number plate light downwards from this position -arrow 2- and out of the opening. ▶



- Detach the number plate light.

### Changing bulb

- Press the defective bulb out of the bulb holder and fit the new bulb.

### Installing number plate light

- First insert the side with the retaining element  
⇒ *page 315*, fig. 311 and then carefully press the number plate light into the opening.
- Check whether the new bulb is working. ■

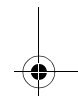
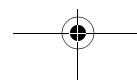
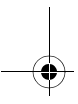
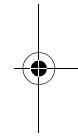
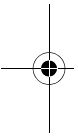

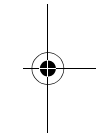
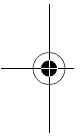
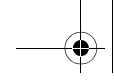

Controls

Safety

Driving tips

General maintenance

Self-help

Technical data

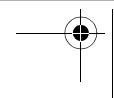
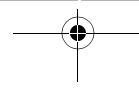
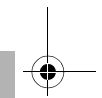

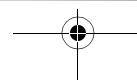
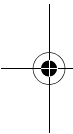



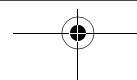
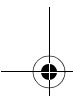
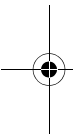

## General notes

### Explanation of technical data

Where not otherwise indicated or separately listed, all technical data apply to vehicles with standard equipment for the German market. Other figures may apply for special versions and export models.

Please note that the details listed in the **vehicle's registration documents** can be taken as correct.

#### Engine data

The figures for engine power output are determined according to EU standards.

#### Performance figures

The performance figures were measured without equipment which may influence performance, such as mudflaps or extremely wide-section tyres.

#### Kerb weight (unladen weight)

These figures (kerb weight according to the currently applicable version of EU Directive 92/21/EEC) apply to the vehicle with the tank 90% full, with no special equipment. The figures include an additional 75 kg to allow for the weight of the driver.

When towing a trailer, the **gross vehicle weight** may be exceeded by up to 30 kg and the **maximum rear axle weight** may be exceeded by up to 80 kg.

#### Maximum trailer weights

The maximum trailer weights are calculated in accordance with the currently applicable version of EU Directive 92/21/EEC.

The figures for a **trailer with brakes, on gradients up to 8%** are applicable only up to a maximum speed of 80 km/h (even though higher speeds may be permitted when towing a trailer in some countries).

The figures for a **trailer with brakes on gradients up to 12%** and for the **weight of car and trailer on gradients up to 12%** are applicable up to a maximum speed of 100 km/h. This maximum speed must **not** be exceeded even in countries where higher speeds are permitted.

#### Maximum draw bar loading

The vertical load exerted by the trailer drawbar on the ball joint of the towing bracket must not exceed **80 kg**.

In the interest of safety, we recommend applying the **maximum permitted draw bar weight**. **The stability of the trailer could be adversely affected if too little weight is applied.**

If the **maximum** permitted drawbar weight cannot be obtained, e.g. when using small or light trailers, statutory regulations require that the drawbar weight be at least 4% of the actual trailer weight (for single-axle trailers or twin-axle trailers with an axle spacing less than 1.0 m). ■

### Dimensions

Length	mm	4703
Width	mm	1826
Width across mirrors	mm	1953
Height, unladen <sup>1)</sup>	mm	1417-1437

<sup>1)</sup> The height of the vehicle depends on the tyres and suspension.

Take care not to damage low-mounted parts of the car (such as the spoiler or exhaust system) on steep ramps, uneven road surfaces or roadside kerbs, etc.

This applies especially when the vehicle is fully laden. ■

## Capacities

### Fuel tank

Front-wheel drive	ltr.	approx. 65
Four-wheel drive	ltr.	approx. 64

### Windscreen washer

Windscreen and headlight washer system*	ltr.	approx. 4.5
-----------------------------------------	------	-------------

## Vehicle identification data

You can also find the vehicle ID number on the sound system or MMI\*.



Fig. 312 Display: Vehicle identification number

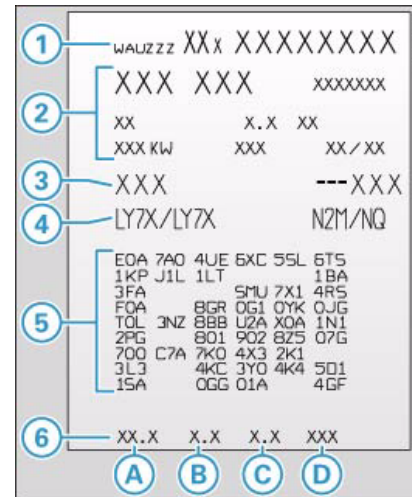

Fig. 313 Vehicle data sticker

- Select: Function selector button **CAR** > **Vehicle ID number** ⇒ fig. 312.

### Vehicle identification number in the engine compartment

The vehicle identification number is located on the right-hand side of the engine compartment.

### Type plate

The type plate is located on the right-hand side of the engine compartment. Vehicles for certain export countries have no type plate.

### Vehicle data sticker

The vehicle data sticker ⇒ fig. 313 is located near the battery in the luggage compartment. One section of the vehicle data sticker is



attached to the inside cover of the Service Schedule before the vehicle is handed over.

The sticker lists the following data:

- ① Vehicle identification number (chassis number)
- ② Vehicle type / engine power / gearbox type
- ③ Engine and gearbox code letters
- ④ Paint No. / Interior equipment No.
- ⑤ Optional equipment codes
- ⑥ Fuel consumption and emissions

#### Fuel consumption and emissions

Information on the vehicle's fuel consumption and emissions is given at the bottom of the vehicle data sticker ⑥:

- A Urban cycle consumption (ltr./100 km)
- B Extra-urban cycle consumption (ltr./100 km)
- C Combined cycle consumption (ltr./100 km)
- D Combined CO<sub>2</sub> emissions (g/km)

The specified values were determined in accordance with the test procedure prescribed by the currently applicable version of Directive 80/1268/EEC. The specifications do **not** refer to an individual vehicle. The consumption figures achieved during normal driving may differ from the test values quoted in accordance with the above Directive, depending on special equipment fitted, vehicle loading, personal driving style, road and traffic conditions, environmental factors and the condition of the car. ■

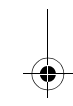
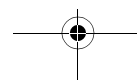
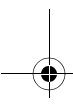
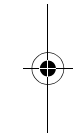
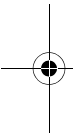

## Performance, weights and dimensions

### Petrol engines

#### A4 1.8

##### Engine data

Power output	118 kW at 4500 - 6000 rpm
Maximum torque	250 Nm at 1500 - 4500 rpm
Cylinders, capacity	4 cylinders, 1,798 cm <sup>3</sup>
Fuel	Premium unleaded 95 RON or regular unleaded 91 RON <sup>1)</sup>

##### Performance figures

	MG	AG
Maximum speed km/h	225	218
Acceleration from 0 - 100 km/h sec.	8.6	8.6

##### Weights

	MG	AG
Gross vehicle weight kg	1960	2000
Kerb weight (unladen weight) kg	1410	1450
Maximum front axle weight kg	1035	1060
Maximum rear axle weight kg	1050	1060

##### Maximum trailer weights<sup>2)</sup>

	MG	AG
Trailer with brakes on gradients up to 8% kg	1500	1500
Trailer with brakes on gradients up to 12% kg	1300	1300
Weight of vehicle and trailer on gradients up to 12% kg	3330	3370
Trailer without brakes kg	740	750

##### Engine oil

<i>LongLife Service</i>	VW 503 00, VW 504 00
<i>Inspection Service</i>	VW 502 00, VW 503 00, VW 504 00
Engine oil capacity (including filter change)	approx. 4.6 litres

MG = Manual gearbox / AG = Automatic gearbox

<sup>1)</sup> With slight loss of power

<sup>2)</sup> The specified trailer weights apply only to vehicles with a factory-fitted towing bracket. ■

### A4 3.2 quattro

#### Engine data

Power output	195 kW at 6500 rpm
Maximum torque	330 Nm at 3000 - 5000 rpm
Cylinders, capacity	6 cylinders, 3,197 cm <sup>3</sup>
Fuel	Premium unleaded 95 RON or regular unleaded 91 RON <sup>1)</sup>

#### Performance figures

Maximum speed	km/h	MG = 250
Acceleration from 0 - 100 km/h	sec.	MG = 6.2

#### Weights

Gross vehicle weight	kg	MG = 2130
Kerb weight (unladen weight)	kg	MG = 1580
Maximum front axle weight	kg	MG = 1105
Maximum rear axle weight	kg	MG = 1145

#### Maximum trailer weights<sup>2)</sup>

Trailer with brakes on gradients up to 8%	kg	MG = 2100
Trailer with brakes on gradients up to 12%	kg	MG = 1900
Weight of vehicle and trailer on gradients up to 12%	kg	MG = 4100
Trailer without brakes	kg	MG = 750

#### Engine oil

<i>LongLife Service</i>	VW 503 00, VW 504 00
<i>Inspection Service</i>	VW 502 00, VW 503 00 VW 504 00
Engine oil capacity (including filter change)	approx. 6.2 litres

MG = manual gearbox

<sup>1)</sup> With slight loss of power

<sup>2)</sup> The specified trailer weights apply only to vehicles with a factory-fitted towing bracket. ■

## Diesel engines

### A4 2.0 TDI

#### Engine data<sup>1)</sup>

Power output	105 kW at 4200 rpm
Maximum torque	320 Nm at 1750 - 2500 rpm
Cylinders, capacity	4 cylinders, 1,968 cm <sup>3</sup>
Fuel	Diesel

#### Performance figures

	MG	AG
Maximum speed	215 km/h	210
Acceleration from 0 - 100 km/h	9.4 sec.	9.4

#### Weights

	MG	AG
Gross vehicle weight	2010 kg	2045
Kerb weight (unladen weight)	1460 kg	1495
Maximum front axle weight	1075 kg	1100
Maximum rear axle weight	1065 kg	1070

#### Maximum trailer weights<sup>2)</sup>

	MG	AG
Trailer with brakes on gradients up to 8%	1900 kg	1900
Trailer with brakes on gradients up to 12%	1700 kg	1700
Weight of vehicle and trailer on gradients up to 12%	3780 kg	3815
Trailer without brakes	750 kg	750

#### Engine oil

<i>LongLife Service</i>	VW 506 01, VW 507 00 vehicles with diesel particulate filter*: only VW 507 00
<i>Inspection Service</i>	VW 505 00, VW 505 01, VW 506 01, VW 507 00 vehicles with diesel particulate filter*: only VW 507 00
Engine oil capacity (including filter change)	approx. 5.0 litres

MG = Manual gearbox / AG = Automatic gearbox

<sup>1)</sup> This engine is available with reduced power for some markets (see car documentation). The performance figures may be slightly different.

<sup>2)</sup> The specified trailer weights apply only to vehicles with a factory-fitted towing bracket. ■

**A4 2.7 TDI****Engine data<sup>1)</sup>**

Power output	140 kW at 3500 - 4000 rpm
Maximum torque	400 Nm at 1400 - 3250 rpm
Cylinders, capacity	6 cylinders, 2,698 cm <sup>3</sup>
Fuel	Diesel

**Performance figures**

Maximum speed	km/h	AG = 226
Acceleration from 0 - 100 km/h	sec.	AG = 7.7

**Weights**

Gross vehicle weight	kg	AG = 2145
Kerb weight (unladen weight)	kg	AG = 1595
Maximum front axle weight	kg	AG = 1180
Maximum rear axle weight	kg	AG = 1080

**Maximum trailer weights<sup>2)</sup>**

Trailer with brakes on gradients up to 8%	kg	AG = 1900
Trailer with brakes on gradients up to 12%	kg	AG = 1700
Weight of vehicle and trailer on gradients up to 12%	kg	AG = 3915
Trailer without brakes	kg	AG = 750

**Engine oil**

<i>LongLife Service</i>	VW 506 01, VW 507 00 vehicles with diesel particulate filter* only VW 507 00
<i>Inspection Service</i>	VW 505 00, VW 505 01, VW 506 01, VW 507 00 vehicles with diesel particulate filter*: only VW 507 00
Engine oil capacity (including filter change)	approx. 6.9 litres

AG = automatic gearbox

<sup>1)</sup> This engine is available with reduced power for some markets (see car documentation). The performance figures may be slightly different.

<sup>2)</sup> The specified trailer weights apply only to vehicles with a factory-fitted towing bracket. ■



### A4 3.0 TDI quattro

#### Engine data

Power output	176 kW at 4000 - 4400 rpm
Maximum torque	500 Nm at 1500 - 3000 rpm
Cylinders, capacity	6 cylinders, 2,967 cm <sup>3</sup>
Fuel	Diesel

#### Performance figures

Maximum speed	km/h	MG = 250 (governed)
Acceleration from 0 - 100 km/h	sec.	MG = 6.1

#### Weights

Gross vehicle weight	kg	MG = 2205
Kerb weight (unladen weight)	kg	MG = 1655
Maximum front axle weight	kg	MG = 1180
Maximum rear axle weight	kg	MG = 1140

#### Maximum trailer weights<sup>1)</sup>

Trailer with brakes on gradients up to 8%	kg	MG = 2100
Trailer with brakes on gradients up to 12%	kg	MG = 1900
Weight of vehicle and trailer on gradients up to 12%	kg	MG = 4175
Trailer without brakes	kg	MG = 750

#### Engine oil

<i>LongLife Service</i>	VW 506 01, VW 507 00  vehicles with diesel particulate filter*: only VW 507 00
<i>Inspection Service</i>	VW 505 00, VW 505 01, VW 506 01, VW 507 00  vehicles with diesel particulate filter*: only VW 507 00
Engine oil capacity (including filter change)	approx. 6.9 litres

MG = manual gearbox

<sup>1)</sup> The specified trailer weights apply only to vehicles with a factory-fitted towing bracket. ■

Controls

Safety

Driving tips

General maintenance

Self-help

Technical data

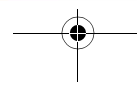
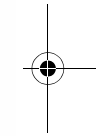
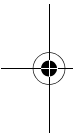

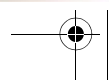
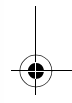
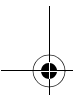
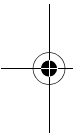
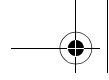

**A**

- Abroad
  - Changing headlight dip settings ..... 59
- ABS
  - See Anti-lock brake system ..... 19
- AC mode ..... 98, 107
- Acceleration figures
  - See Performance, weights and dimensions ..... 323
- Accessories ..... 277
  - Trailer ..... 235
- Acoustic parking aid ..... 169
- Adapter for anti-theft wheel bolts ..... 292
- adaptive cruise control ..... 128
  - Driver intervention prompt .... 130, 138
  - Driver messages ..... 134
  - Driving program ..... 139
  - Error messages ..... 136
  - Indicator lamps ..... 134
  - No vehicle in front ..... 130
  - Overriding ..... 130
  - Setting a new speed ..... 131
  - Setting distance ..... 133
  - Setting speed ..... 131
  - Setting time interval ..... 133
  - Settings ..... 139
  - Status messages ..... 136
  - Switching off (with memory function) ... 131, 132
  - Switching on and off ..... 131
  - System limitations ..... 140
  - Vehicle in front ..... 130
- Vehicles with manual gearbox ..... 129
- Volume of warning tone ..... 139
- adaptive light ..... 61
  - Defective ..... 39
- advanced key
  - Locking and unlocking the vehicle ... 47
  - START ENGINE STOP button ..... 118
  - Starting the engine ..... 118
  - Switching on the ignition ..... 118
- Air conditioner ..... 93, 101
  - AC mode ..... 98
  - See also Deluxe automatic air conditioner 93
- Air recirculation mode
  - Deluxe automatic air conditioner .... 97
  - Deluxe automatic air conditioner plus ... 105
- Airbag ..... 201
  - Deactivating ..... 208
  - Front airbags ..... 203
  - Head-protection airbag ..... 207
  - Key-operated switch for front passenger's airbag ..... 208
  - Side airbags ..... 205
  - Triggering ..... 202
  - Warning lamp ..... 17
- Alarm system
  - See Anti-theft alarm system ..... 42
- Alterations to the vehicle ..... 277
- Alternator
  - Fault ..... 32
- Anti-dazzle interior mirror ..... 69
- Anti-freeze additive ..... 260
- Anti-knock properties of petrol ..... 251
- Anti-lock brake system
  - How the system works ..... 222
  - Warning lamp ..... 19
- Anti-theft alarm system ..... 42
  - Interior monitor ..... 50
  - Tow-away protection ..... 50
- Anti-theft wheel bolts ..... 292
- Armrest (front)
  - Adjusting ..... 78
  - Storage compartment ..... 78
- Ashtrays
  - Front ..... 86
  - Rear ..... 86
- Audi braking guard ..... 142
  - Error messages ..... 143
  - Settings ..... 144
  - Status messages ..... 143
  - Switching on and off ..... 144
- Audi drive select ..... 159
  - Dynamic steering ..... 159
  - Suspension control ..... 159
- Audi hold assist ..... 124
  - Warning lamp ..... 19
- Audi lane assist
  - See lane assist ..... 145
- Audi parking system ..... 169
- Audi parking system advanced ..... 171
- Audi parking system plus ..... 170
- Auto Lock ..... 42
- Auto-check control ..... 30

Automatic air conditioner plus  
 See Deluxe automatic air conditioner plus  
 101

Automatic cruise control  
 See adaptive cruise control ..... 128

Automatic gearbox  
 Dynamic gear control program ..... 166  
 Kick-down feature ..... 165  
 Manual release (multitronic®) ..... 168  
 multitronic® ..... 162  
 Paddle levers (tiptronic mode) ..... 167  
 Safety interlock for ignition key ..... 116  
 Selector lever lock ..... 165  
 Selector lever positions ..... 163  
 Steering wheel with paddle levers .. 167  
 tiptronic ..... 162, 166

Automatic headlight control ..... 57

Automatic headlights ..... 59

Auxiliary heating  
 Deluxe automatic air conditioner plus ..  
 110  
 Description ..... 110  
 Remote control ..... 113  
 Running time ..... 112  
 Switching on/off immediately ..... 111  
 Timer ..... 111

Average fuel consumption ..... 25

Average speed ..... 25

Axle weights  
 See Performance, weights and  
 dimensions ..... 323

**B**

Battery  
 Charging ..... 265  
 Low charge ..... 226  
 Power level ..... 226  
 Power management ..... 226  
 Replacing ..... 266  
 Winter conditions ..... 263

Battery power ..... 38

Bayonet fastener  
 Bulb ..... 305  
 Bulb holder ..... 306

Belt tensioners ..... 199

Bicycle rack  
 Trailer ..... 235

Biodiesel ..... 251

Bioethanol fuel ..... 251

Blower  
 Deluxe automatic air conditioner ..... 96  
 Deluxe automatic air conditioner plus ..  
 104

Bonnet  
 Closing ..... 256  
 Opening ..... 254  
 Releasing ..... 254

Boot  
 See Loading luggage compartment . 192  
 See Luggage compartment ..... 79

Boot lid  
 Central locking system ..... 51  
 Manual release ..... 52

Brake system  
 Brake assist system ..... 222  
 Brake fluid ..... 262  
 Brake light defective ..... 37  
 Brake pads worn ..... 37  
 Brake servo ..... 224  
 Electro-mechanical parking brake ... 121  
 General notes ..... 224  
 Malfunction ..... 32  
 Warning lamp ..... 20

braking guard  
 See Audi braking guard ..... 142

Bulb holder  
 Bayonet fastener ..... 306

Bulb monitor ..... 37

Bulbs  
 Bayonet fastener ..... 305  
 Changing (general notes) ..... 304

Bulbs, changing ..... 304

Brake lights ..... 311

Bulb holder with bayonet fastener . 305,  
 306

Dipped headlights ..... 308

Front fog lights ..... 310

Main beam headlights ..... 307

Number plate light ..... 315

Rear fog light ..... 314

Rear lights ..... 311

Reversing light ..... 314

Turn signals (rear) ..... 311

Business equipment ..... 278

Controls

Safety

Driving tips

General maintenance

Self-help

Technical data

**C**

Capacities	321
Car keys	43
Care of vehicle	244
Catalytic converter	229
Central locking system	42
Boot lid	51
Deadlock mechanism	48
Fuel tank flap	252
Locking	48
Locking and unlocking the vehicle from inside	49
Manual locking	51
Opening and closing windows	54
Sun roof	54
Switches on driver's door	49
Unlocking	48
Cetane number	251
Changing a wheel	288
Changing bulbs	
See Bulbs	304
Chassis number	321
Child safety	210
Side airbags	212
Child safety seat	213
Child seat categories	213
Fitting	216
ISOFIX system	218
On front passenger's seat	211
Safety notes	210
Child-proof catches	
Rear doors	53

Cigarette lighter	87
Cleaning	244
Cleaning Alcantara	250
Cleaning seat covers	
Alcantara	250
Natural leather	249
Textile covers	247
Cleaning textile covers and trim parts	247
Clock, setting	13
Closing	
Bonnnet	256
Sun roof	55
Coat hooks	91
Colour code	321
coming home	59
Compact temporary spare wheel	
See Spare wheel	284
Compartment for (sun)glasses	91
Compass in mirror	71
Controls and displays	
Overview	9
Convenience open/close function	54
Cooling system	
Anti-freeze additive	260
Checking coolant level	261
Coolant	260
Coolant temperature gauge	11
Malfunction	33
Radiator fan	262
Topping up coolant	261

Cruise control system	
Adjusting stored speed	126
Indicator lamp	19
Pre-selecting a speed	127
Switching off	127
Switching on	125
See also adaptive cruise control	128
Cup holders	85
Current fuel consumption	25
<b>D</b>	
Date display	13
Daytime running lights	59
DCP	
See Dynamic gear control program	166
Deactivating front passenger's airbag	208
Deadlock mechanism	42, 48
Defrosting windows	98, 106
Deluxe automatic air conditioner	93
Air distribution	97
Air outlets	99
Air outlets for rear passengers	99
Air recirculation mode	97
Automatic mode	95
Basic settings	100
Blower	96
Controls	94
Defrosting	98
Description	93
Economical operation	100
Heated rear window	98
Seat heating, front	114

Supplementary heater . . . . .	101	Dipped headlights . . . . .	57	Driving on left . . . . .	59
Switching on and off . . . . .	95	Defective . . . . .	37	Driving on right . . . . .	59
Temperature . . . . .	96	DIS		Driving safety . . . . .	187
Deluxe automatic air conditioner plus . .	101	See Driver information system . . . . .	21	Driving time . . . . .	25
AC mode . . . . .	107	Distance control system		Dust filter	
Air distribution . . . . .	106	See adaptive cruise control . . . . .	128	Deluxe automatic air conditioner . . . . .	93
Air outlets . . . . .	107	Door catches/boot lid warning . . . . .	24	Deluxe automatic air conditioner plus . .	101
Air outlets for rear passengers . . . . .	108	Doors		DVD player . . . . .	80
Air recirculation mode . . . . .	105	Child-proof catches . . . . .	53	Dynamic gear control program . . . . .	166
Automatic mode . . . . .	103	Manual locking . . . . .	51	Dynamic steering . . . . .	16, 36, 159, 222
Automatic recirculation . . . . .	109	Driver			
Auxiliary heating . . . . .	110	See Sitting position . . . . .	188	<b>E</b>	
Auxiliary heating - remote control . . . .	113	Driver information system . . . . .	21	Economical driving . . . . .	229
Auxiliary heating - running time . . . . .	112	Auto-check control . . . . .	30	EDL	
Basic settings . . . . .	109	Bulb monitor . . . . .	37	See Electronic differential lock . . . . .	19
Blower . . . . .	104	CD and radio display . . . . .	22	Electric seat adjustment	
Controls . . . . .	102	Digital speedometer . . . . .	23	See Seat adjustment . . . . .	74
Defrosting . . . . .	106	Door catches/boot lid warning . . . . .	24	Electric windows . . . . .	53
Description . . . . .	101	Driver messages . . . . .	30	Central locking system . . . . .	54
Economical operation . . . . .	108	On-board computer . . . . .	25	Convenience open/close function . . . . .	54
Heated rear window . . . . .	106	Outside temperature display . . . . .	22	Malfunctions . . . . .	55
Supplementary heater . . . . .	110	Red symbols . . . . .	31	Settings . . . . .	55
Switching on and off . . . . .	103	Service interval display . . . . .	24	Electrical accessories	
Synchronisation . . . . .	109	Speed warning . . . . .	28	See Electrical socket . . . . .	88
Temperature . . . . .	104	Yellow symbols . . . . .	35	Electrical socket . . . . .	87, 88
Diesel . . . . .	251	Driver messages . . . . .	30	Electro-mechanical parking brake . . . . .	124
Diesel particulate filter . . . . .	38, 229	Driving		Auto release function . . . . .	122
Engine oil . . . . .	257	Run flat tyres . . . . .	275	Driving away from a standstill . . . . .	122
Digital clock . . . . .	13	Driving abroad		Driving away when towing a trailer . . . .	123
Digital compass . . . . .	71	Headlights . . . . .	59	Emergency braking function . . . . .	123
Digital speedometer . . . . .	23	Unleaded fuel . . . . .	251	Malfunction . . . . .	123
Dimensions . . . . .	320	Driving away from a standstill . . . . .	122		
		Driving away when towing a trailer . . . .	123		

Controls

Safety

Driving tips

General maintenance

Self-help

Technical data

- Operation ..... 121  
 Parking ..... 122  
 Releasing and applying ..... 121  
 Warning lamp ..... 19, 20  
 Electronic differential lock  
   How the system works ..... 222  
   Warning lamp ..... 19  
 Electronic immobiliser ..... 14, 43  
 Electronic stabilisation program  
   How the system works ..... 222  
   Warning lamp ..... 17  
 Emergency braking function ..... 123  
 Emergency key ..... 45  
 Emergency release  
   Ignition key ..... 46  
 Emission control systems  
   Catalytic converter ..... 229  
   Diesel particulate filter ..... 229  
 Emissions ..... 321  
 Engine compartment  
   Safety notes ..... 255  
 Engine compartment layout ..... 256  
 Engine data  
   See Performance, weights and  
   dimensions ..... 323  
 Engine hood  
   See Bonnet ..... 254  
 Engine management  
   (EPC) warning lamp ..... 16  
 Engine oil ..... 34, 257  
   Checking oil level ..... 258, 259  
   Consumption ..... 258, 259  
   LongLife Service ..... 257  
   Topping up ..... 259  
   See also Performance, weights and  
   dimensions ..... 323  
 Engine oil capacity  
   See Performance, weights and  
   dimensions ..... 323  
 Engine oil pressure  
   Warning lamp ..... 33  
 Engine oil sensor  
   Malfunction ..... 38  
 Environmental compatibility ..... 231  
 Environmental tips  
   Filling the tank ..... 252  
   Heated rear window ..... 98, 106  
   Leaks ..... 255  
   Roof carrier ..... 84  
 EPC  
   See Engine management ..... 16  
 ESP  
   See Electronic stabilisation program . 17  
 Ethanol fuel ..... 251  
 Exterior mirrors ..... 70  
**F**  
 Fastening rings ..... 79, 193  
 Filling the tank ..... 252  
   Releasing the tank flap manually ... 253  
 Fire extinguisher ..... 283  
 First-aid kit ..... 282  
 Floor mats ..... 191, 192  
 Fog lights ..... 58  
 Four-wheel drive ..... 226  
 Front passenger  
   See Sitting position ..... 189  
 Fuel  
   Biodiesel ..... 251  
   Capacity ..... 321  
   Consumption ..... 321  
   Current fuel consumption ..... 25  
   Diesel ..... 251  
   Ethanol ..... 251  
   Fuel level low ..... 37  
   Petrol ..... 251  
   Saving fuel ..... 229  
 Fuel consumption ..... 321  
 Fuel range ..... 25  
 Fuel tank flap ..... 252  
 Fuse, changing ..... 300  
**G**  
 Garage door opener ..... 179  
 Gear-change indicator ..... 22  
 Generator  
   See Alternator ..... 32  
 Glove box ..... 90  
 Glow plug system  
   Indicator lamp ..... 16  
**H**  
 Handbrake  
   See Electro-mechanical parking brake ...  
   121



Hazard warning lights . . . . .	61				
Indicator lamp . . . . .	18				
Head restraints		Ignition key			
Front seats . . . . .	77	Emergency release . . . . .	46	Jack . . . . .	283, 290
Rear seats . . . . .	78	Safety interlock . . . . .	116	Jacking points . . . . .	290
Headlamp converter . . . . .	59	Ignition lock . . . . .	116	Jump-starting . . . . .	293
Headlight flasher . . . . .	62	Malfunction . . . . .	34, 39		
Headlight range control . . . . .	60	Immobiliser . . . . .	14, 43	<b>J</b>	
Malfunction . . . . .	39	Indicator lamps . . . . .	15		
Headlights . . . . .	57	adaptive cruise control . . . . .	134	<b>K</b>	
adaptive light . . . . .	61	Cruise control system . . . . .	19	Key-operated switch for front passenger's	
Changing dip settings . . . . .	59	Glow plug system . . . . .	16	airbag . . . . .	208
Driving abroad . . . . .	59	Main beam headlights . . . . .	18	Keys . . . . .	43
Headlight range control . . . . .	60	Overview . . . . .	15	Emergency key . . . . .	45
Washer system . . . . .	67	Trailer turn signals . . . . .	18	Replacement keys . . . . .	43
Heated		Turn signals . . . . .	18	Replacing the battery . . . . .	45
Exterior mirrors . . . . .	70	Inflation pressures (tyres) . . . . .	39, 268	Kick-down feature . . . . .	165
Front seats (deluxe automatic air		Inspection intervals . . . . .	24		
conditioner) . . . . .	114	Instrument cluster . . . . .	11	<b>L</b>	
Rear seats . . . . .	115	Instrument lighting . . . . .	59	lane assist	
Rear window . . . . .	98, 106	Interior lights		Changing settings on the MMI . . . . .	147
Washer jets . . . . .	65	Dimming . . . . .	63	Description . . . . .	145
Heated rear window . . . . .	98, 106	Front . . . . .	63	Indicator lamp in instrument cluster . . . . .	145
Heating		Rear . . . . .	63	Instrument cluster display . . . . .	146
Deluxe automatic air conditioner . . . . .	93	Interior mirrors		Switching on and off . . . . .	145
Deluxe automatic air conditioner plus . . . . .	101	See Mirrors . . . . .	68, 69	Leather care	
HomeLink . . . . .	179	Interior monitor . . . . .	50	Alcantara . . . . .	250
Horn . . . . .	9	Intermittent wipe . . . . .	65	Natural leather . . . . .	249
		Rain sensor . . . . .	65	leaving home . . . . .	59
		ISOFIX . . . . .	218	Light sensor . . . . .	57
				Light sensor defective . . . . .	37
				Lights . . . . .	57
				coming home . . . . .	59
				Daytime running lights . . . . .	59

- Exterior lighting ..... 59
- Front fog lights ..... 58
- Headlight control ..... 57
- leaving home ..... 59
- Rear fog lights ..... 58
- Switching on and off ..... 57
- Loading luggage compartment ..... 192
- Load-through hatch ..... 82
- Locking ..... 47
- Central locking system ..... 48
- Locking and unlocking the vehicle from inside
- Central locking system ..... 49
- Locking doors manually ..... 51
- LongLife Service ..... 257
- Luggage compartment ..... 79
- Extending ..... 81
- Fastening rings ..... 79
- Loading ..... 79
- Side storage compartment ..... 80
- Stretch net ..... 80
- Transport bag ..... 82
- See also* Loading luggage compartment . . . 192
- Luggage rack
- See* Roof carrier ..... 83
- M**
- Main beam headlights ..... 62
- Indicator lamp ..... 18
- Make-up mirrors ..... 64
- Manual operation
- Boot lid ..... 52
- Fuel tank flap ..... 253
- Manual release
- Selector lever (multitronic®) ..... 168
- Maximum speed
- See* Performance, weights and dimensions ..... 323
- Memory for driver's seat ..... 75
- Activating remote control key ..... 77
- Recalling settings ..... 76
- Storing settings ..... 76
- Messages ..... 30
- Mileage recorder ..... 14
- Minimising pollution ..... 229
- Mirrors
- Anti-dazzle setting ..... 69
- Automatic anti-dazzle exterior mirrors . 71
- Automatic anti-dazzle interior mirror . 69
- Exterior mirrors ..... 70
- Interior mirror ..... 68
- Make-up mirrors ..... 64
- MMI control console, cleaning ..... 247
- MMI display, cleaning ..... 247
- Mobile phones ..... 278
- Modifications ..... 277
- multitronic® ..... 162
- Driving with multitronic® ..... 162
- N**
- Natural leather ..... 248
- Number plate light
- Changing bulb ..... 315
- O**
- Octane rating ..... 251
- Oil
- See* Engine oil ..... 258, 259
- Oil consumption ..... 258, 259
- Oil dipstick ..... 258
- Oil level ..... 38
- On-board computer ..... 25
- Opening
- Bonnet ..... 254
- Sun roof ..... 55
- Outside temperature display ..... 22
- Overview ..... 9
- P**
- Paddle levers
- tiptronic ..... 167
- Paint damage ..... 246
- Paint No. .... 321
- Parking ..... 122
- Parking brake ..... 121
- Parking lights ..... 62
- parking system ..... 169
- Reversing camera, parking mode 1 .. 174
- Reversing camera, parking mode 2 .. 175
- Safety notes on reversing camera ... 172
- Switching graphic display on and off 177

Switching reversing camera on and off . . . . . 177	<b>Q</b>	Replacement keys . . . . . 43
Towing bracket . . . . . 177	Quartz clock . . . . . 13	Replacement parts . . . . . 277
parking system advanced . . . . . 171	quattro	Reset button . . . . . 14
parking system plus . . . . . 170	See Four-wheel drive . . . . . 226	Retaining net . . . . . 80
Parking the car	<b>R</b>	Rev counter . . . . . 12
multitronic® . . . . . 162	Radio transmitters . . . . . 278	Reverse gear
Particulate filter	Fixed installation . . . . . 278	Automatic gearbox . . . . . 163
See Diesel particulate filter . . . . . 229	Mobile equipment . . . . . 278	Reversing camera
Passengers	Radio-controlled clock . . . . . 13	Parking mode 1 . . . . . 174
See Sitting position . . . . . 189	Radio-operated remote control	Parking mode 2 . . . . . 175
Pedals . . . . . 191	See Remote control keys . . . . . 43	RME fuel . . . . . 251
Performance figures	Rain sensor . . . . . 65	Roof carrier . . . . . 83
See Performance, weights and	Rain sensor defective . . . . . 37	Attachment points . . . . . 84
dimensions . . . . . 323	Reading lights	Roof load . . . . . 84
Performance, weights and dimensions . . . . . 323	Front . . . . . 63	Run flat tyres . . . . . 274
General notes . . . . . 320	Rear . . . . . 63	Driving . . . . . 275
Personalised remote control key . . . . . 43	Rear centre console	Introduction . . . . . 274
Petrol . . . . . 251	Socket . . . . . 89	Renewing defective components . . . . . 276
Polishing . . . . . 245	Rear fog lights . . . . . 58	Tyres . . . . . 274
Pollen filter	Rear lights	Running in . . . . . 229
Deluxe automatic air conditioner . . . . . 93	Defective . . . . . 37	New engine . . . . . 229
Deluxe automatic air conditioner plus . . . . . 101	Rear View camera	New tyres . . . . . 268
Pollution filter	See Reversing camera . . . . . 173	<b>S</b>
Deluxe automatic air conditioner . . . . . 93	Rear view mirrors	SAFE . . . . . 14
Deluxe automatic air conditioner plus . . . . . 101	See Mirrors . . . . . 68, 69	Safe driving . . . . . 186
Power management . . . . . 226	Rear window, sun blind . . . . . 64	Safety . . . . . 187
Battery power . . . . . 228	Remote control keys . . . . . 43	Safety features . . . . . 186
Driver message . . . . . 228	Indicator lamp . . . . . 44	Seat adjustment
Power steering . . . . . 16, 36, 225	Replacing the battery . . . . . 45	Backrest angle (manual) . . . . . 73
Pressure (tyres) . . . . . 39	Unlocking and locking . . . . . 47	Electrical . . . . . 74
		Forwards and backwards (manual) . . . . . 73

Controls

Safety

Driving tips

General maintenance

Self-help

Technical data

- Manual ..... 73  
 Seat height (manual) ..... 73  
 Seat belt height adjustment ..... 199  
 Seat belts ..... 194  
   Adjusting seat belts ..... 197  
   Belt tensioners ..... 199  
   Cleaning ..... 250  
   During pregnancy ..... 198  
   Height adjustment ..... 199  
   Putting on ..... 197  
   Safety notes ..... 195  
   Taking off ..... 199  
   Warning lamp ..... 18  
 Seat heating ..... 114  
   Front (deluxe automatic air conditioner) .  
     114  
   Rear ..... 115  
 Seat memory ..... 75  
 Selector lever  
   Manual release (multitronic®) ..... 168  
 Selector lever positions ..... 163  
 Service interval display ..... 24  
 Service position for windscreen wipers . 67  
 servotronic ..... 225  
 side assist  
   Area covered by sensors ..... 151  
   Changing settings in the MMI ..... 155  
   Description ..... 149  
   How the system works ..... 151  
   Information and warning modes ... 151  
   Messages in instrument cluster display .  
     156  
   Safety notes ..... 157  
   Switching on and off ..... 149  
 Side lights ..... 57  
 Single journey memory ..... 26  
 Sitting position  
   Driver ..... 188  
   Front passenger ..... 189  
   Incorrect sitting position ..... 191  
   Rear passengers ..... 189  
 Ski bag ..... 82  
 Snow chains ..... 273  
 Sockets  
   230 Volt ..... 89  
 Spare key ..... 43  
   Starting the engine ..... 46  
 Spare parts ..... 277  
 Spare wheel ..... 284  
 Speed warning ..... 28  
 Speedometer ..... 14, 23  
 Starting the engine  
   After fuel tank has been run dry .... 252  
   Jump-starting ..... 293  
   Spare key ..... 46  
   Tow-starting ..... 295  
   Starting with jump leads ..... 293  
 Status messages ..... 30  
 Steering ..... 16, 36  
   Locking the steering ..... 116  
   Malfunction ..... 34  
   Steering wheel height adjustment  
     (manual) ..... 116  
 Storage compartments ..... 90  
   Front seats ..... 91  
   Stretch net ..... 80  
   Sun blinds ..... 64  
   Sun roof  
     Convenience open/close function .... 54  
     Opening and closing ..... 55  
   Sun visors ..... 64  
   Supplementary heater  
     Deluxe automatic air conditioner ... 101  
     Deluxe automatic air conditioner plus ...  
       110  
   Suspension control ..... 159  
     Warning lamp ..... 39  
   Switches on driver's door  
     Central locking system ..... 49  
   Switching off the engine ..... 118, 120  
   Symbols ..... 15  
**T**  
 Tailgate  
   See Boot lid ..... 51  
 Tank capacity ..... 321  
 Technical data ..... 320  
 tiptronic ..... 162, 166  
 Tools ..... 283  
 Total journey memory ..... 26  
 Tow-away protection ..... 50  
 Towing  
   Automatic braking ..... 233  
   Trailer stabilisation ..... 233  
   Towing away ..... 295  
   Towing bracket  
     Parking system ..... 177

Towing bracket, removable . . . . .	235	Tread wear indicators . . . . .	270	Seat belt . . . . .	18
Towing bracket, retrofitting . . . . .	240	Tyre pressure monitoring system . . . . .	39, 41	Suspension control . . . . .	39
Towline anchorage		Tyre service life . . . . .	268	Warning triangle . . . . .	282
Front . . . . .	296			Washer fluid level low . . . . .	37
Rear . . . . .	297	<b>U</b>		Washing the vehicle	
Tow-starting . . . . .	297	Universal transmitter . . . . .	179	By hand . . . . .	244
Traction control system . . . . .	222	Unleaded fuel . . . . .	251	Car wash . . . . .	244
Trailer . . . . .	232	Unlocking . . . . .	47	With high-pressure cleaner . . . . .	244
Accessories . . . . .	235	Central locking system . . . . .	48	Waxing . . . . .	245
Notes on towing . . . . .	234			Weights	
Points to check before towing . . . . .	232	<b>V</b>		See Performance, weights and	
Technical requirements . . . . .	232	Vehicle data sticker . . . . .	321	dimensions . . . . .	323
Trailer stabilisation . . . . .	233	Vehicle identification data . . . . .	321	Wheel bolts . . . . .	272
Trailer turn signals		Vehicle identification number . . . . .	321	Wheel imbalance . . . . .	268
Indicator lamp . . . . .	18	Ventilation		Wheels . . . . .	246, 268
Trailer weights		Deluxe automatic air conditioner . . . . .	93	Changing . . . . .	288
See Performance, weights and		Deluxe automatic air conditioner plus . . . . .	101	Changing wheels round . . . . .	270
dimensions . . . . .	323	Ventilation slots . . . . .	192	Window heating . . . . .	98, 106
Tread depth . . . . .	270	<b>W</b>		Windows	
Trip recorder . . . . .	14	Warning lamps . . . . .	15	Cleaning . . . . .	246
Trips, checklist . . . . .	187	Airbag system . . . . .	17	De-icing . . . . .	246
Turn signals . . . . .	62	Anti-lock brake system . . . . .	19	Malfunctions . . . . .	55
Indicator lamp . . . . .	18	Brake system . . . . .	20	Windows (electric)	
Type plate . . . . .	321	Dynamic steering . . . . .	16, 36	See Electric windows . . . . .	53
Tyre Mobility System . . . . .	285	Electro-mechanical parking brake . . . . .	19, 20	Windscreen washer fluid . . . . .	267
Tyre pressure . . . . .	39, 41, 268	Electronic stabilisation program . . . . .	17	Windscreen wiper and washer system . . . . .	65
Tyre pressure monitoring system . . . . .	39, 41	Emission control system . . . . .	18	Windscreen wipers . . . . .	65
Tyre repair kit . . . . .	283	Engine management . . . . .	16	Changing blades . . . . .	68
Tyre Mobility System . . . . .	285			Defective . . . . .	39
Tyres				Service position . . . . .	67
Inflation pressures . . . . .	39, 268			Winter conditions	
Run flat tyres . . . . .	274			Battery . . . . .	263
				Care of vehicle . . . . .	244

Controls

Safety

Driving tips

General maintenance

Self-help

Technical data



Cooling system ..... 260  
Defrosting windows ..... 98, 106  
De-icing windows ..... 246  
Diesel ..... 251  
Seat heating (deluxe automatic air  
conditioner) ..... 114  
Seat heating for rear seats ..... 115  
Snow chains ..... 273  
Tyres ..... 272  
Windscreen washer ..... 267  
Winter tyres ..... 272  
Wiper blades  
See Windscreen wipers ..... 68

**X**

Xenon lights  
Driving abroad ..... 59

